

Figure 12 Overall Block Diagram.

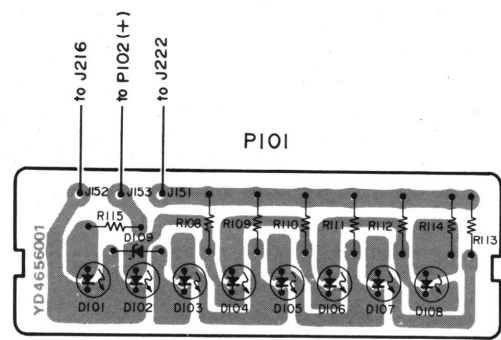

Figure 14 LID Assembly-P101 Component Locations.

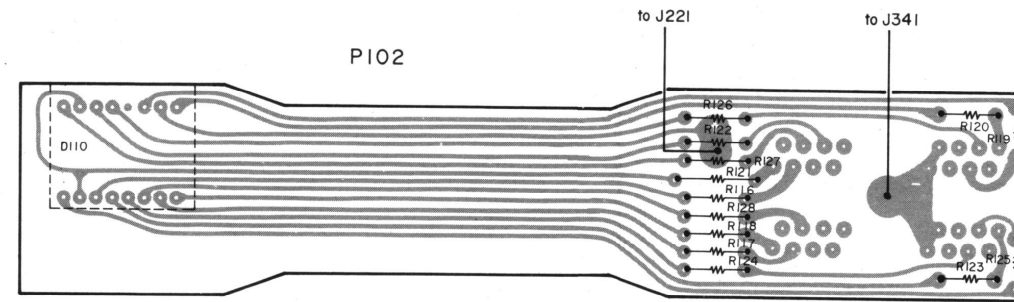

Figure 15 Seg Led Assembly-P102 Component Locations.

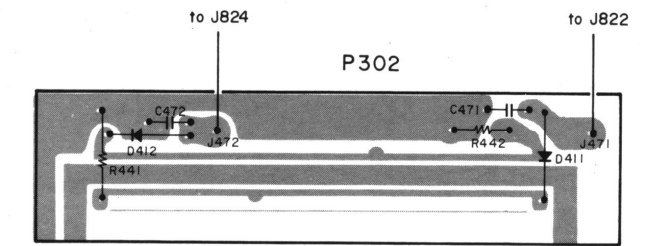

Figure 17 SWR Assembly-P302 Component Locations.

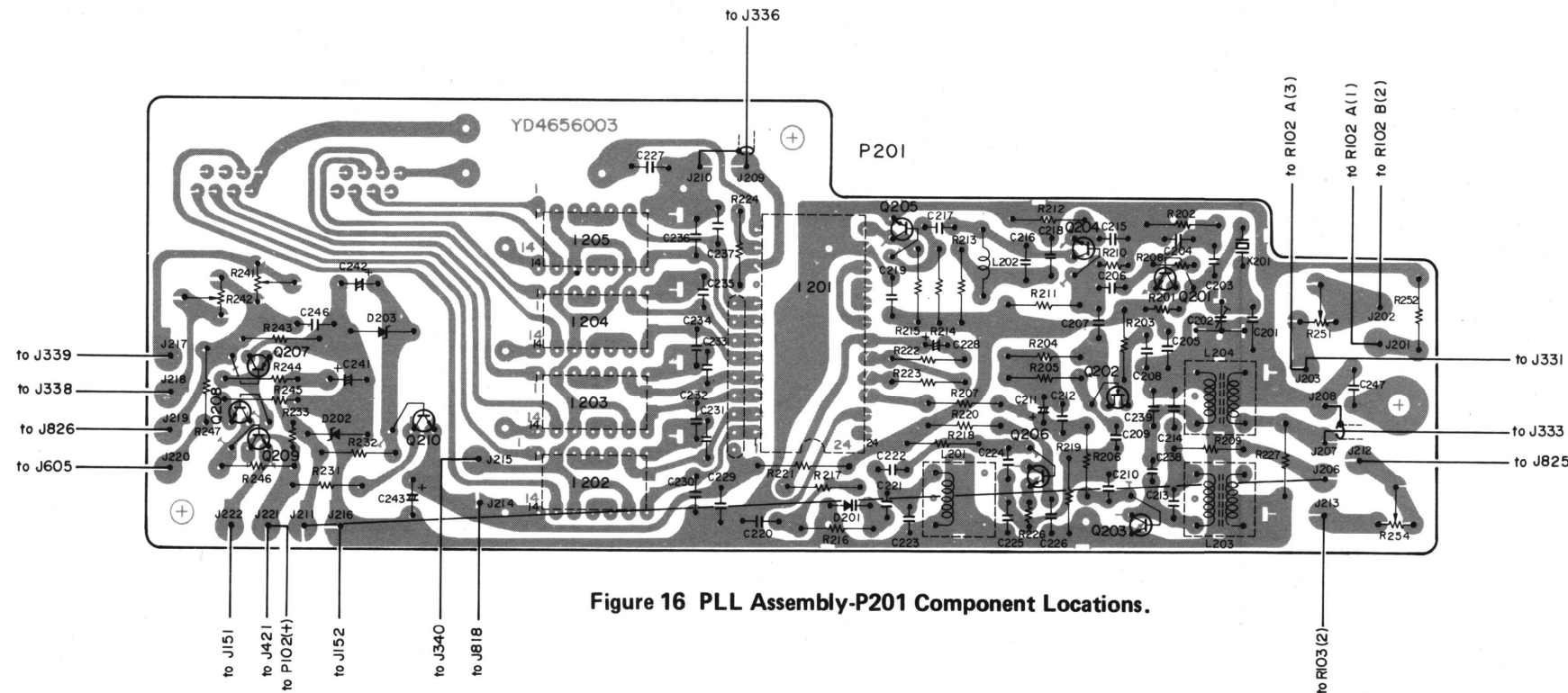

Figure 16 PLL Assembly-P201 Component Locations.

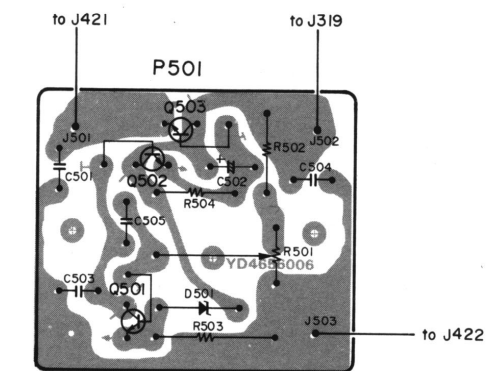

Figure 18 Regulator Assembly-P501 Component Locations.

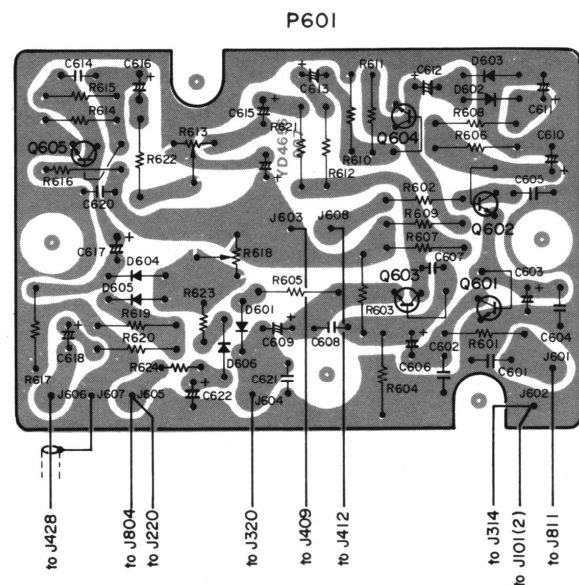

Figure 19 Mic/ALC Amp Assembly-P601 Component Locations.

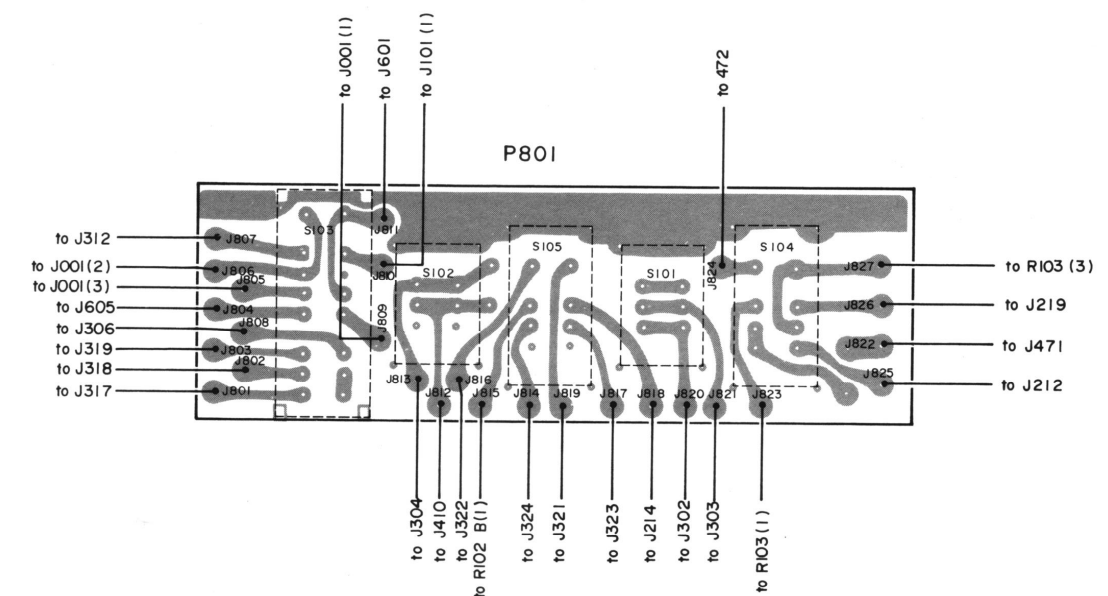

Figure 20 Switch Assembly-P801 Component Locations.

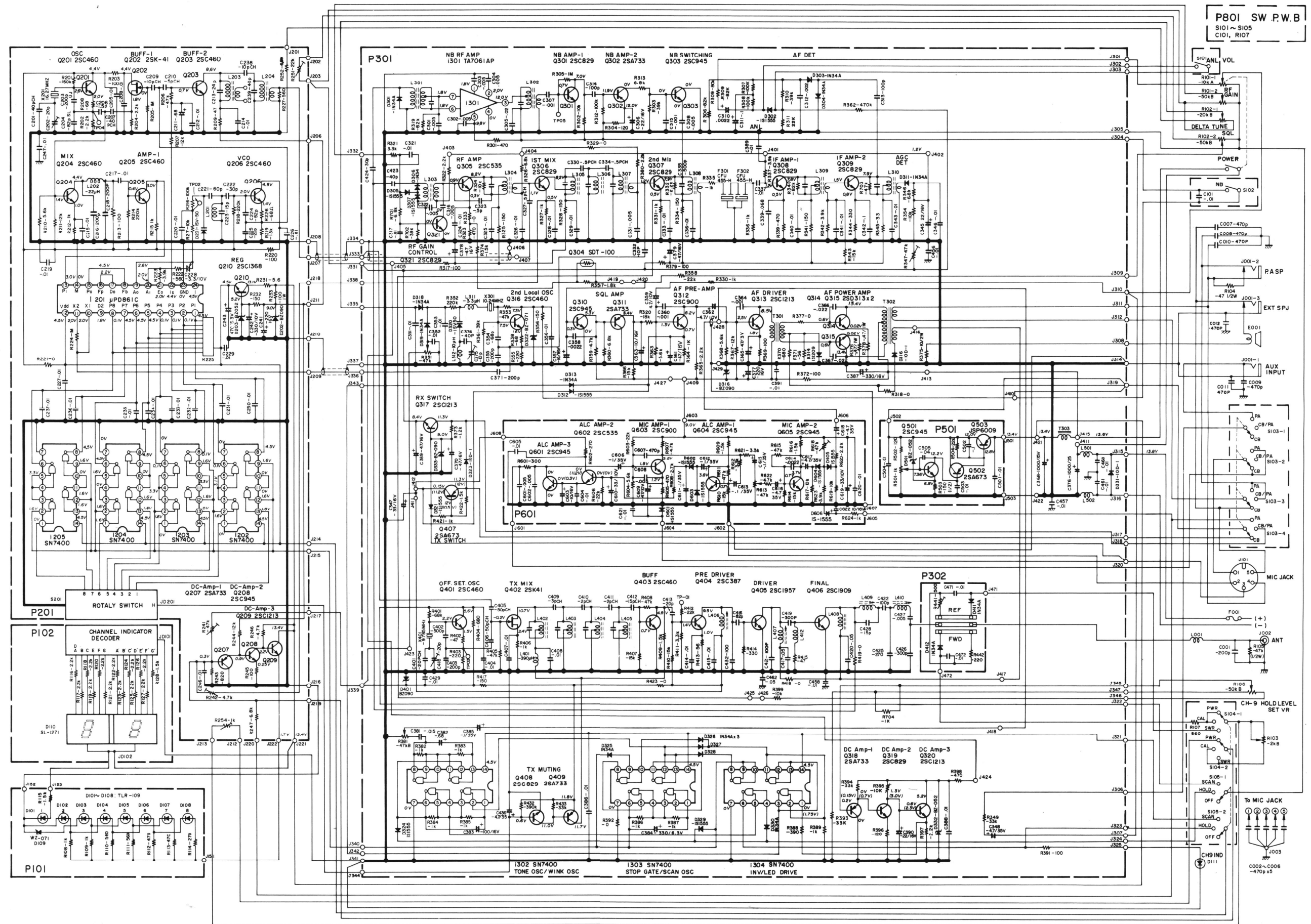
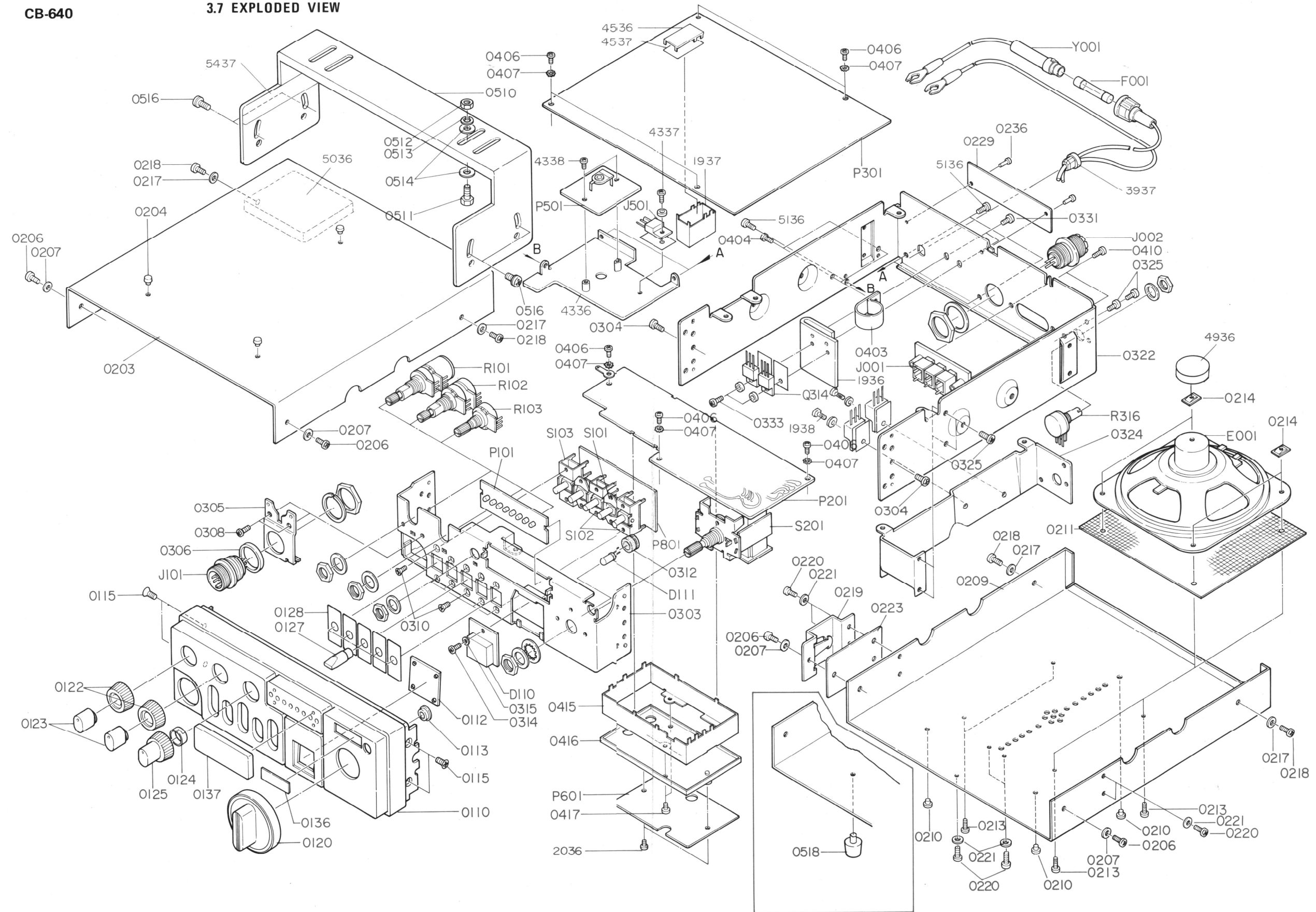

Figure 22 Schematic Diagram.

3.7 EXPLODED VIEW



NOTE

For the microphone exploded view, see page 16.

Figure23 Exploded View.