

SECRET CB[®]



**CONFIDENTIAL
FACTUAL
REPORT**
SCHEMATICS ETC.
UPDATED QUARTERLY

IMPORTANT: READ THIS FIRST

The information in this book is not to be used to exceed F.C.C. specifications, in any case, as applied to power, modulation, frequency spectrum, etc. It is illegal to do this to any CLASS D RADIO.

This book is a factual report of gathered information, and as such is intended for use on radios for EXPORT ONLY.

If you are not familiar with electronics, it is better to check for advice with your local electronics or CB center, as to restrictions, etc., concerning your radio.

More information, on other units will be forthcoming in future issues, to be published on a quarterly basis.

This book will not be found at a book store, but can be obtained through your local CB Dealer or Distributor, or by completing the order form in the book and sending to:

Selman Enterprises, Inc.
P.O. Box 8189
Corpus Christi, Texas 78412

Secret CB
Volume Nine
Published August, 1980

Copyright 1980. All rights reserved in the United States and most foreign countries.

New issues quarterly

Address any and all inquiries to:

Selman Enterprises, Inc.
P.O. Box 8189
Corpus Christi, Texas 78412

(512) 992-1303

ACKNOWLEDGEMENTS

SECRET CB WISHES TO GRATEFULLY ACKNOWLEDGE THE FOLLOWING PEOPLE FOR THEIR HELP AND CONTRIBUTIONS TOWARD GETTING VOLUME 9 IN PRINT. THEIR ENCOURAGEMENT AND CONTRIBUTION OF MATERIAL HAS BEEN INVALUABLE.



JOHN CROOKSHANK
CROOKSHANK COMMUNICATIONS CO.
NORTH AURORA, ILLINOIS

JIM SCHLEITWILER
UNIVERSAL MOBILE
INDIANAPOLIS, INDIANA

DAVID LITTERER
PHILADELPHIA, PENNSYLVANIA

ROBERT LAM
LAMTRONICS
REDDING, CALIFORNIA

JOE SCHLEIN
BALTIMORE, MARYLAND

TRADER BILL
BILL WENTZ
GOODLETTSVILLE, TENNESSEE

JIM ALLEN, EDITOR
SIDEBAND RADIO DIGEST
DAYTONA BEACH, FLORIDA

LARRY SHARP
DALLAS, TEXAS



**Rod says "thanks" and
a free book to the above
people**

INTRODUCTION

It's amazing how much technical knowledge has been set forth since citizens band radio has been in existence. For instance, everyone has "fooled around" so to speak, with linear amplifiers, power mikes, antennas, etc., but so far, no one has come up with an effective way of improving voice quality without tremendously expensive circuitry. We at Secret CB think we have found the solution to the problem with VSB-1. What is it? VSB-1 is an internal modification for communication use that improves both the transmitted and received voice signal without amplifying the noise! The expanding and compressing features are so outstanding and so clear that radios on the other end, receiving a signal processed by a VSB-1, have accused the operator using it of running 100 watts or more. The VSB-1 will not only improve your "talk power", but will improve your modulation and voice quality. The incoming signal is also processed and even a "cheap AM or SSB" sounds like an expensive set --- maybe better.

The VSB-1 sells for just under \$50 and could very well be the biggest breakthrough in the communications industry! We think the VSB-1 is the hottest circuit in its price range!

73's

Rodney D. Johnson
Editor



Mike Miller
Ass't. Editor

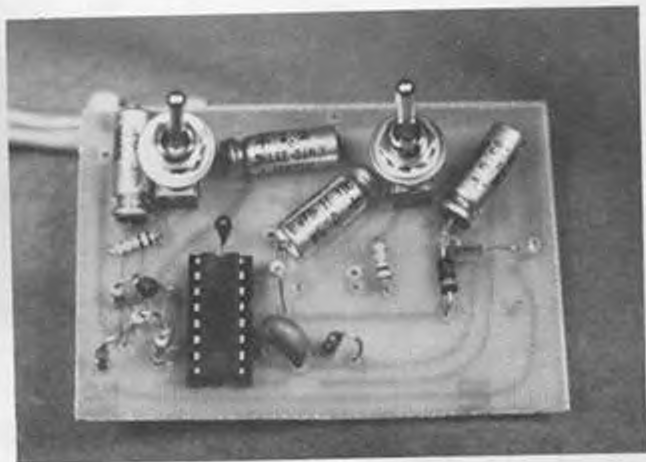

VSB-1

**HOT
NEW
PRODUCT**

TABLE OF CONTENTS

	<u>Page #</u>
SSB'ers Lose Out Again	1
FCC Announces Plans For Sideband	2-3
FCC Delays NPRM; SSB Freqs Doubtful	3-4
Product Review; Speed-0-Matic "SPEEDO-1" X-Band Radar Gun	5-6
CONVERSIONS:	
Conversion Tips For All SSB Radios	7
Uniden 858 PLL Update	8-11
Craig L-132, L-232 Clarifier & Channel Expansion	12
Craig L-131, L-231 Clarifier & Channel Expansion	12-14
PLL 01A For "A" Channels Without Skips (Kraco KCB233A)	15
"A" Channel Modification For All SSB Radios	16-17
Dak IX Modification Update	18-19
Sears Roadtalker 40 (#934-3827) Update Channel Expansion & Slide	20-22
CPI 2000 Base Low Frequency Conversion	23
Superscope Aircommand CB340 (861 PLL) 90+ Channels	24
Relay Crystal Switching	25-26
Letter From A Friend	27-28
Hints & Kinks - Electronic Crystal Switching	29
Specific Radio Tune-Ups	30-39
Solving TVI	40-42
Important Facts About Echo Boxes	43-44
Voice Signal Booster (VSB-1) Installation	45-48
Power Supply Modification For Realistic Pre-Amp Noise- Cancelling Mike #21-1175	49-50
Hints & Kinks - Switchable Modulation Increase	51
RF Attenuator	52-54
PRESIDENT Service Bulletins	55-61
Secret CB Index (Volumes 1-8)	62-70
OOPS! WE GOOFED! (Vol. 8, page 17)	29
OOPS! WE GOOFED! (Vol. 4, page 51)	44

SSB'ERS LOSE OUT AGAIN

EDITOR'S NOTE: THE FOLLOWING ARTICLES ARE REPRINTS FROM SIDEBAND RADIO DIGEST AND WE WISH TO THANK JIM ALLEN, EDITOR, FOR PERMISSION TO USE THEM. THERE HAVE BEEN A LOT OF QUESTIONS FROM OUR SUBSCRIBERS AS TO THE NEW FREQUENCY ALLOCATIONS, AND WE HOPE THE FOLLOWING ARTICLES WILL PROVIDE ANSWERS. WE ALSO HOPE IT WILL MAKE ENOUGH PEOPLE ANGRY ENOUGH TO PUT PRESSURE ON THE FCC AND MAKE THEM QUIT PUTTING OFF THE INEVITABLE.

WHY A FEW FREQUENCIES ARE NOT ENOUGH! (REPRINT FROM SIDEBAND RADIO DIGEST)

For about 16 years, the FCC has failed to respond adequately to the needs and wants of Sidebanders. Yet use of SSB is expanding, despite the "strangle hold" the FCC has tried to keep on it.

IF the FCC had been responsive to SSB growth over the years, there would NOT be any excuse for "illegal" out-of-band operations now!

It's plain and simple. When you try to pour a whole coffee pot of coffee into a single cup, it'll spill out all over the table and all over the floor! That's what's happened to SSB.

Now, it seems the FCC is "playing footsie" with IRAC, which is telling about three-quarters of the SSB population that "if" they'll move off freqs above 27.540, that "in a year or two" the FCC can have these freqs for SSB use, but not now.

It's like telling everyone to move from their nice rural and suburban homes, and cram in with others into an inner-city house or apartment. Why?

Somebody is forgetting that it's serious Sidebanders who've escaped to higher freqs, who the FCC must now rely upon to "pioneer" LEGAL operating!

To accomplish this, "peer pressure" is needed and best exerted within a small group of serious operators like those on the higher freqs, but perhaps impossible where the crowded conditions prevail below 27.540.

Those who try "peer pressure" on a crowd below 27.540, may get disgusted or nauseated and flee back to higher freqs. It's human nature. And then we're back to "square one".

IF the "government" operations were concentrated above 27.960 MHz, and IF they'd USE those freqs enough to be heard, we think that SSBers would stay off freqs above 27.955 MHz.

With this "compromise", ALL COULD be LEGAL!

FCC ANNOUNCES PLANS FOR SIDEBAND

REPRINT FROM JAN.-FEB. '80
SIDEBAND RADIO DIGEST

The FCC Commissioners have instructed the FCC's Private Radio Bureau to prepare a Notice of Proposed Rulemaking (NPRM) for exclusive Single-Sideband (SSB) communications in the Citizens Band (CB) Radio Service. This was the result of an open meeting of the FCC on Dec. 19.

Specifically, the FCC News Release said, the Commissioners directed the Bureau staff (quote) to draft a proposal to:

- reallocate frequencies between 27.410 and 27.540 MHz to the Citizens Band Radio Service for SSB-only operation;
- amend the rules to permit limited transmitter tuning (a VXO control) on all channels for single-sideband only;
- amend the rules to permit domestic communications beyond the existing 150-mile (250 km) limit, provided that such an amendment does not conflict with international radio regulations;
- eliminate the five-minute transmission time rule;
- allow modification of existing CB equipment to include new features and channels;
- inquire into the possibility of testing SSB-only operators as part of the licensing procedure. (end quote from News release)

The FCC decision came as a result of the Commissioners' favorable consideration of a report presented by the Bureau staff which evaluated a number of alternatives, including the problems of incompatibility between SSB and AM operation, channel congestion, and a regulatory plan unsuitable for SSB type operation. This was in response to two Petitions, RM-3299 and RM-3317.

The FCC points out that NO changes in rules have yet occurred, but this is a step toward solving SSB problems.

Although not in the news release, reports say the new SSB channels are to be 5 kc apart. Also, it's hoped that arrangements can be made with Canadian officials to include Canada in this SSB-only band.

How to administer "testing for the new band, caused much discussion at the Dec. 19 meeting. This magazine's Editor had just submitted to the FCC a proposal outlining a testing procedure which could permit "immediate" licensing, but the FCC is currently dealing with a problem of "volunteer" examiners on Amateur bands which must be resolved first.

"SSB-only" band expansion stops at 27.540 MHz because IRAC (the Interdepartmental Radio Advisory Committee) is refusing to release the additional frequencies to the FCC. In fact, a NASCAN report says the NTIA (National Telecommunications Information Administration) is currently forming an enforcement unit to act against those who cause interference to the Government frequencies above 27.540 MHz, and primarily around these six frequencies: 27.575, 585, 625, 750, 900, and 27.980 MHz.

FCC ANNOUNCES (Cont'd):

One report said that IRAC allegedly promised to release the frequencies between 27.540 and 28 MHz to the FCC for Sideband-only use "in a year or two", but only IF people would vacate and stay off those frequencies in the meantime.

FCC DELAYS NPRM; SSB FREQS DOUBTFUL

REPRINT FROM MAY-JUNE '80
SIDEBAND RADIO DIGEST

(By Chuck Hensarling, Washington State CB Radio Assoc.)

As far as the FCC is concerned, the proposal for a more disciplined "special license SSB hobbyist radio sub-service" at 27.MHz is essentially dead.

It has been learned that the present version of the Notice of Proposed Rule-Making (NPRM) calls for a mere expansion of the present CB Radio Service to add a few additional channels in the frequency band above Channel 40 (27.41 to 27.54 MHz).

Special licensing and testing for a SSB sub-service is no longer under consideration.

There is major opposition to any type of expansion at 27 MHz within the FCC. This was confirmed by Mr. Ronald Stone, Chief of the Policy Development Division, FCC Private Radio Bureau, on May 1, 1980.

The reason given for this change in policy, is that there are no funds available to implement new programs. Although the comments on the petitions by potential users of the SSB radio service indicated a willingness to pay a fee for special licensing and testing, this has been rejected. The FCC Office of General Counsel has ruled that a fee cannot be collected for this type of license until a fee schedule has been established for all types of FCC licenses. The FCC has not charged any fees for licenses since the courts ruled their fees for various licenses were unfair and arbitrary. The FCC has not yet developed new fee schedules in accordance with the court guidelines.

According to Stone, the only way the original proposal could be restored, is if the funds are made available to finance the new program. The FCC could ask Congress for a budget supplement to support the program, but this action is unlikely in view of recent budget cuts and "the Commission policy in this regard."

Congress could provide the necessary funding and direct the FCC to implement the new program, if enough people would request it.

Information now indicates the NPRM in its revised version won't be released to the public until July, 1980, at the earliest.

As this writer sees it, the latest turnabout of the FCC concerning the SSB radio service at 27 MHz, is a disappointment, not only because it appears that we have lost, but because it raises serious questions as to the integrity of the FCC as a Government agency.

FCC DELAYS (Cont'd):

On the one hand, the FCC is spending a great deal of time, effort, and tax-payer funds to encourage public participation in rule-making proceedings. Meanwhile, when the public does participate, it does not appear to have any effect on the actions of the FCC as an agency.

There are some sincere individuals in the FCC who do attempt to act in the overall public interest. However, there are several major Offices and Bureaus within the FCC that have to approve a proposal. Individuals in any one of these can effectively block or indefinitely delay action on a proposal which they oppose.

At the public hearing before the Commission on Dec. 19, '79, concerning SSB frequencies, the various FCC Bureaus and Offices had the opportunity to publicly present their views in opposition to the proposal. It had been undergoing coordination and study by the FCC staff for over seven months.

At the public hearing, there was no significant opposition to the proposal. However, after the Commissioners essentially approved the SSB proposal, those who opposed it began their opposition in earnest. This opposition is being conducted under the cloak of secrecy to prevent scrutiny by the public.

It is the same old story being repeated again. The manufacturer and amateur lobby will have their way, and the public be damned. Statements that there are no funds for new programs is simply standard procedure for Government agencies when they don't want to do something.

I believe that merely submitting comments on the NPRM, when and if it is released, will not change anything.

It simply does not make sense to confine the estimated 50 million personal radio service users to only 40 channels when unused frequencies are available. The FCC has a basic responsibility to Congress to allocate and administer the available frequency spectrum in the overall best interests of the public. If the FCC requires additional funding to carry out their programs, only Congress can authorize it.

Once the ill fated NPRM is released, we are going to have to make a decision on whether to capitulate to a bureaucratic Government agency, or take the fight to Congress again.

The question is whether there are enough people left that would make a commitment to attain the goal.

Chuck Hensarling
Washington State CB Radio Assoc'n
(author of petition RM-3317)

PRODUCT REVIEW

SPEED-O-MATIC "SPEEDO-1" X-BAND RADAR GUN

Every state in the Union is using police radar for precise speed measurement. Despite a handful of cases that are thrown out of court, radar speed tickets usually stick.

Passive radar detectors -- those that sell for around one hundred dollars -- are a good companion on a long trip. They will give you a few seconds warning before you are within radar tracking distance. There are many passive radar detectors on the market, and all offer good protection on both X as well as K-band police radar.

A more sensitive radar detector is the "super het" receiver. Selling from two hundred to three hundred dollars, the super het receiver offers exceptional radar detection range. Passive detectors sound off in seconds before radar is incurred -- the super heterodyne receiver will sound off almost a full minute before you are in the clutches of the law.

Speed-o-matic Corporation, Harbor City, California, is the only manufacturer presently importing a Japanese super het radar detector. Extensive field tests indicate that this unit is as good as domestically built radar detectors. The Speed-o-matic super het radar detector receiver "Phantom X-K" sells for two hundred and twenty-nine dollars, and offers the same performance as more expensive two hundred and ninety-nine dollar super het radar detectors.

ACTIVE JAMMING

For those of you that may wish to possess the ultimate counter-measure in thwarting police radar, the jammer may be just for you. First of all, let us get one thing up front -- active jamming is illegal. It is also quite effective.

To jam or deceive police radar, a transmitter on or near the police radar's frequency is required. Further, it should be modulated to simulate a "doppler beat" for the speed one would like displayed on the police radar indicator.

While the police radar is very sensitive for the mode in which it operates (called OIF) it has another mode present (which is less sensitive) which can be attacked by a jamming system. This is the straight "diode detection" mode. While the jammer has a power advantage, the radar has a selectivity advantage.

The bottom line is that power is required to jam. About one hundred milliwatts is required at the vehicle to effectively jam a police radar. This, incidentally, is marginal power with a radar target such as an eighteen-wheeler, so a combination of radar cross-section reduction and jamming increases your edge in beating that ticket.

SPEED-O-MATIC "SPEED-O 1" (Cont'd):

There are a couple of jammer units available which are either dedicated to, or convertible to, actual police radar jammers.

- These are:
1. Microwave Specialties (Texas) builds a "radar communicator" which operates on the amateur radio band adjacent to the X band police radar frequency. To be legal, it requires a ham radio license to operate. The speed you wish the police radar to receive is settable from the control panel. It is expensive. It is priced around eight hundred dollars.
 2. Speed-o-matic Corporation (Harbor City, California) builds a legitimate radar speedometer for vehicles on either the X band or the K band. The X band unit sells for under three hundred dollars, and the K band unit for under four hundred dollars.

While the odds on interfering with police radar's normal operations are almost nil, Speed-o-matic units do have a transmitter portion that is easily modified by removing one simple jumper wire. We advise against modifying these units in this way unless you are a technician doing repair work on police radar units and wish to use it for calibration and test equipment.

There are also extender horns to raise the effective power of the Speed-o-matic unit.

Keep in mind the following if you intend to start jamming:

1. Your radar detector will no longer work as it will pick up your own jammer machine.
2. On large targets, such as tractor trailers, it is best to get a further "edge" by reducing the radar cross section of the vehicle or increasing your radiated power with an extender horn.
3. Both radar bands, X and K bands, are an issue. For the ultimate, you are going to need two jammers -- one on each band.

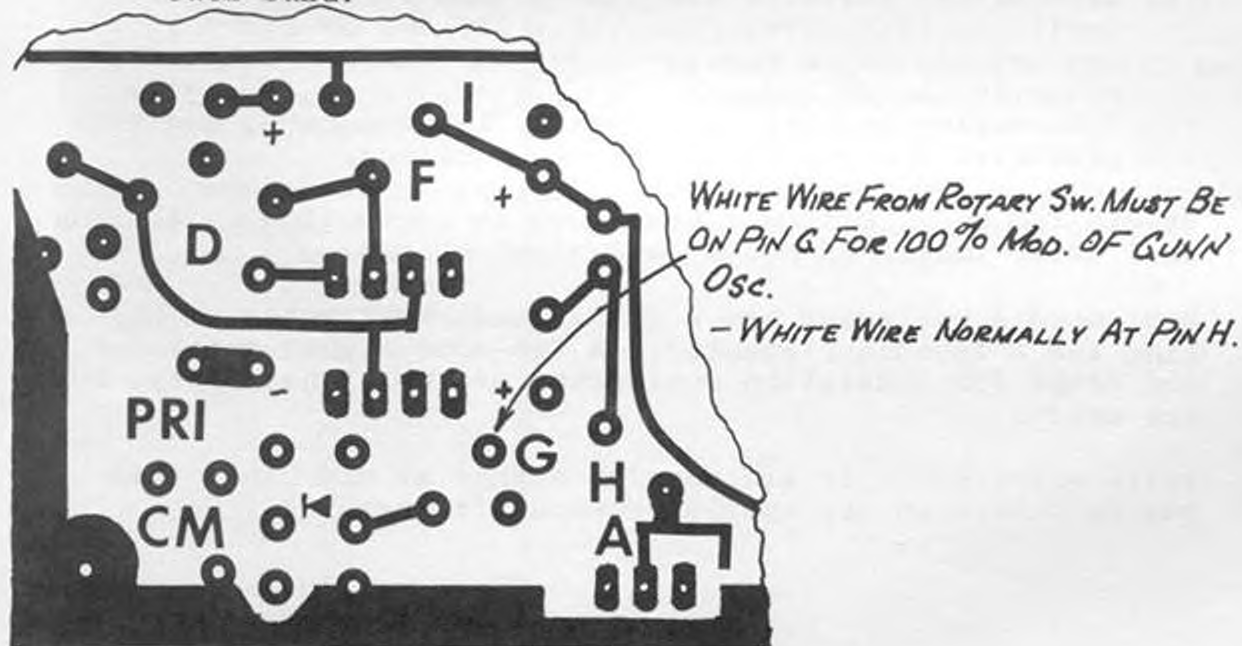

CONVERSION TIPS FOR ALL SSB RADIOS

1. In some cases, since these CB sets are fixed pi networks, changing the fixed load capacitance to 50-100pF less, will improve loading and power output, if you run into problems.
2. Sometimes, mixers will not tune fully. It may be necessary to remove 1-2 turns on some mixer coils - 1 turn for mixers in the 30MHz range, and 2 turns for mixers under 20MHz.
3. AM SLIDER: Using our slider kit, a 10KC slide with AM sets can be achieved. Installing the series coil and capacitor in series with a fundamental set of crystals to ground, incremented channels can be achieved.
 1. Isolate ground buss of fundamental crystals in 8-16 MHz range. Series slider kit to ground and adjust coil for desired slide.
4. Never attempt a conversion without a schematic of your radio.
5. All synthesizer chassis are aligned as follows:
 - (a) Crystal oscillators of associated changed crystals are checked, trimmed if so designed in set.
 - (b) Mixer stages following the synthesizer circuits are aligned next. A frequency counter is helpful at this point. Output frequencies of mixer stages are listed on schematics.
 - (c) Following antenna circuit back from the relay to coils labelled 27 MHz, lead to receiver alignment.
 - (1) Use a modulated signal at mid-band
 - (2) Peak coils for maximum audio output and/or maximum "S" meter reading.
 - (3) In general, IF stages may be left alone.
 - (d) Transmitter circuits are traced back from the final amplifier transistor (usually a 2SC1307 or equiv.) and are peaked in reverse order for maximum output while in the AM mode.
 - (e) SSB exciter peaking is necessary in some sets, and this circuitry follows the balanced modulator.
6. In the SSB mode, ultimate power out is controlled by ALC control after tuning of driver and final stages.
7. Most needed equipment are a dummy load, watt meter of any kind and a frequency counter. A two-tone signal generator and scope for modulation monitoring are not a necessity, but are useful.
8. While receiver coils are usually peaked at mid-band, they may be peaked on any special desired frequency.

UNIDEN 858 PLL UPDATE

ROTARY SWITCH KIT FOR FREQUENCIES 26,255 - 28,045 FOR UNIDEN 858 CHASSIS,

PARTS NEEDED:

- 11 each 1N914 diodes or equivalent
- 1 each 2-Pole, 6 position rotary switch
- 1 each DPDT toggle switch (may also use CB/PA switch instead)
- 2 each 4700 ohm resistors

IF FREQUENCY RANGE INDICATOR LIGHTS ARE DESIRED:

- 6 each LED diodes, your choice
- 1 each 1K resistor

Locate the D858 PLL chip - see Figure 1.

- Step 1: Isolate Pin 19 from P.C. ground. Connect one end of a 4700 ohm resistor to pin 19, and the other end to P.C. ground.
- Step 2: Isolate Pin 21 as close as possible to the chip. Connect one end of a 4700 ohm resistor to Pin 21, and the other end to P.C. ground.
- Step 3: Connect wires long enough to reach from PLL chip to desired locations of rotary and DPDT switches. Connect wires to pins 21, 20, 19, 17, and to the cut-away portion of the land going to pin 21. Also connect one wire to P.C. ground and one to the switched side of the on-off switch. (The last two connections can be omitted if indicator lights are not desired). See figure 1 for illustrated connection points.
- Step 4: Connect diodes and LED's if desired to rotary switch as illustrated in figure 2. Connect wires to DPDT switch as in figure 2.
- Step 5: Connect wires from PLL to rotary and DPDT switches as in figure 1 & 2. Mount switches and LED's where desired. See chart for channel/frequency range.

CUT PINS 19, 21 AS SHOWN. INSTALL 4.7K Ω RESISTORS ACROSS CUTS TO P.C. GROUND AS SHOWN. INSTALL SWITCH WIRES TO POINTS MARKED "X".

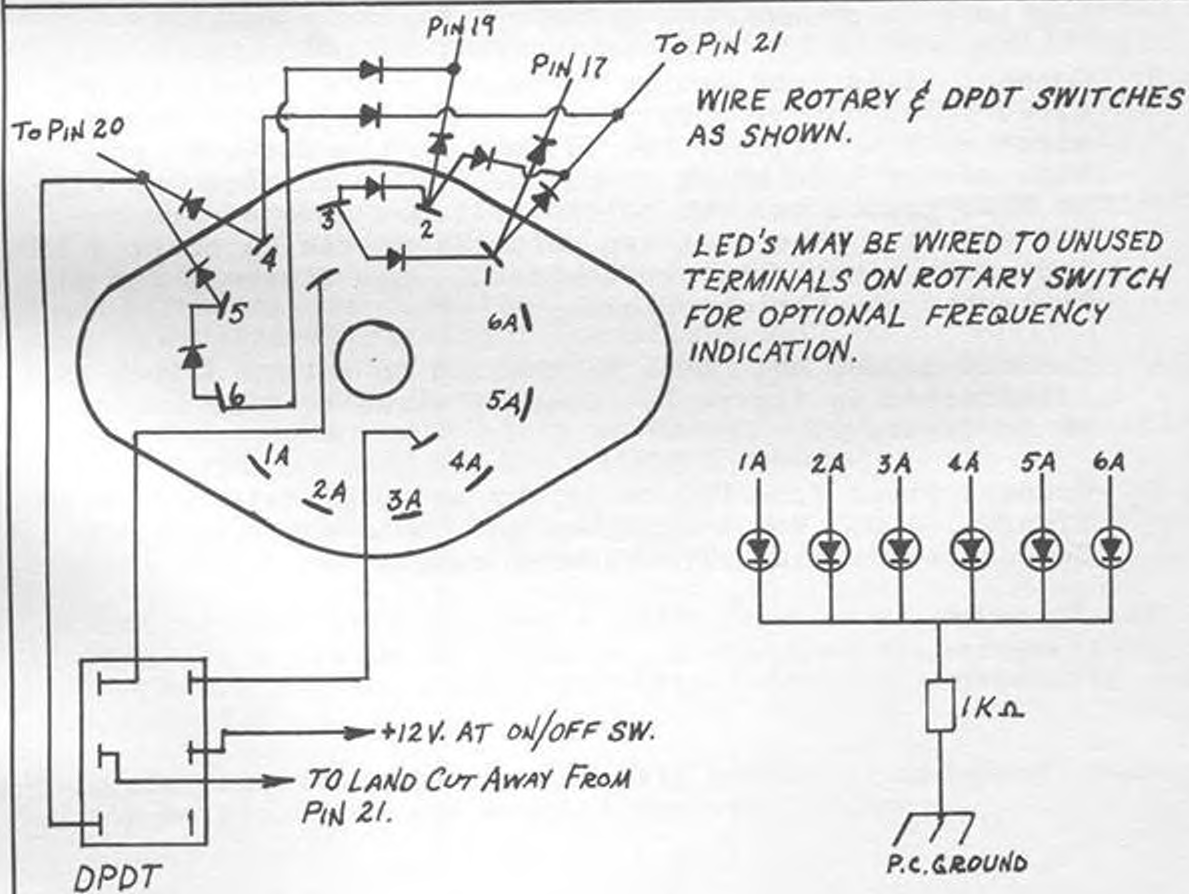
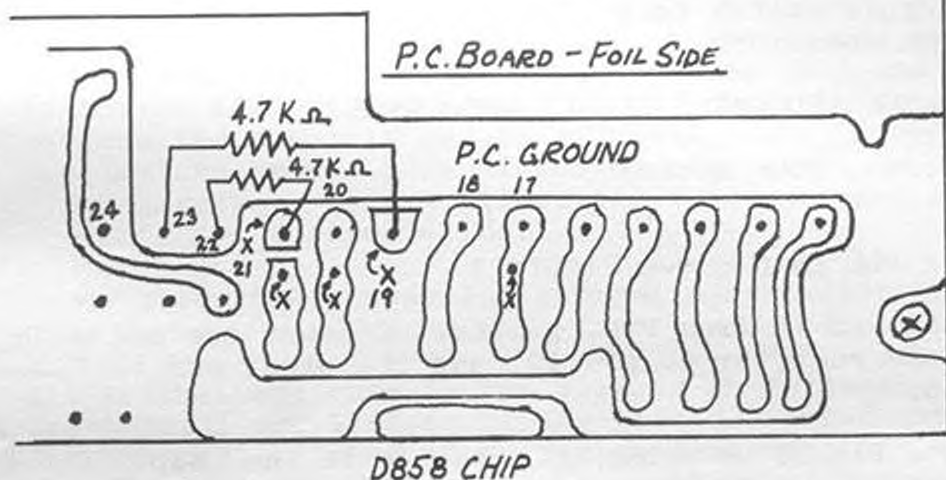

FREQUENCY CHART

NOTE: When DPDT switch is off, all channels are normal, regardless of rotary switch position (also no indicator lights will show). When DPDT switch is on, radio will be operating in out-of-band mode and frequency ranges will be indicated by the appropriate LED's. Also, channels 1-7 will always be normal (unaffected) by either DPDT or rotary switch positions.

DPDT OFF: Normal Channels

DPDT ON : Frequencies controlled by rotary switch as follows:

POSITION 1: 27.415-.445, channels 31-34
 POSITION 2: 27.455-.805, channels 8-40
 POSITION 3: 27.815-.845, channels 31-34
 POSITION 4: 27.855-28.045, channels 8-25
 POSITION 5: 26.855-27.045, channels 8-25
 also : 26.255-26.405, channels 23-40
 POSITION 6: 26.455-26.805, channels 8-40

NOTE: Placing the rotary switch in between positions 5 and 6 will give frequencies 26.085-26.405.

This is one of the nicest working conversions we have seen, and is an easy to follow switch conversion for the 858 PLL rigs. Note that there are no HF gaps that cannot be reached by clarifier sliding down 10 KHz.

Want to custom tailor your 858 chassis to a specific frequency range? Use the following information to determine how to hook up the switches.

Pin 21 - Adds 1 MHz. Normally on from channels 8-40. Cut this pin loose and you go down 1 MHz on channels 8-40.

Pin 20 - Adds 800 KHz. Normally on from channels 1-7. Cut it loose on channels 1-7 and you go down 800 KHz. Switch +5V to this pin on channels 8-40 and you go up 800 KHz.

Pin 19 - Adds 400 KHz. Not normally used. Remove from PC ground and switch +5V to this pin and you go up 400 KHz. If pins 19 and 20 are used together, you will go down 400 KHz from where pin 20 would normally put you.

Pin 18 - Adds 200 KHz. Normally used from channels 23-40.

Pin 17 - Adds 100 KHz. Used in various places. Switch +5V to this pin and you can get to 27.415-27.445 and 27.815-27.845 on channels 31-40. Also 26.415-26.445 and 26.815-26.845. See below for other combinations necessary to pick these up.

UNIDEN 858 PLL UPDATE (Cont'd):

APPLICATIONS:

- 27.415-27.445 - +5V to pin 17 (channels 31-34)
- 27.455-27.805 - +5V to pin 19 (channels 8-40)
- 27.815-27.845 - +5V to pins 19 and 17 (channels 31-34)
- 27.855-28.045 - +5V to pin 20 (channels 8-25)
- 26.855-27.045 - 0V to pin 21 (cut loose) and +5V to pin 20 (channels 8-25)
- 26.455-26.805 - 0V to pin 21, +5V to pins 20 and 19 (channels 8-40)
- 26.085-26.405 - 0V to pin 21 (channels 11-40)
- 26.415-26.445 - 0V to pin 21, +5V to pin 17 (channels 31-34)
- 26.815-26.845 - 0V to pin 21, +5V to pins 20, 19, 17 (channels 31-34)

NOTE: The most convenient place to take your +5V is off of the land going to pin 21. This way channels 1-7 will always be normal. Otherwise, on some switch positions, channels 1-7 will be normal, and on some other positions 1-7 will be out-of-band and it gets rather confusing. Using the above information will get you to any frequency from 26.085 to 28.045, so there is no advantage to using channels 1-7 for extra frequencies. Use a 1N914 or equivalent to take +5V from pin 21 land; anode connected to the land, and cathode going to the switch.

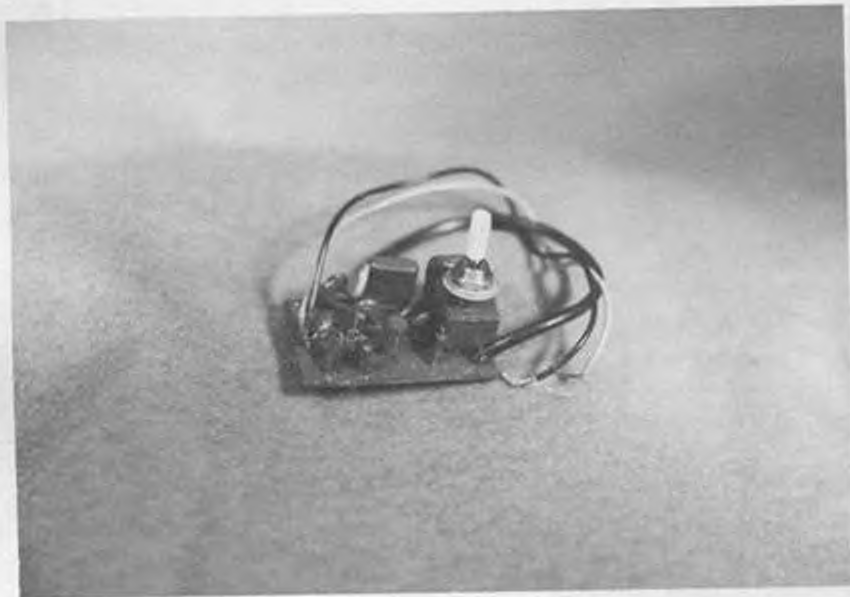

ZAPPER 9000

OSCILLATOR MODULE - FOR THOSE HARD TO CONVERT AM RADIOS, SUCH AS COBRA AND PRESIDENT AM AND MANY OTHERS,

*Correction
Vol 18
Page 79*

CRAIG L-132, L-232

CLARIFIER & CHANNEL EXPANSION

SLIDER

1. The white wire from the clarifier should be cut loose from the P/C board and reconnected to ground. Connect the black/white wire from the clarifier pot to Pin 3 of IC5.
2. Remove R142 and D55. This will allow +1.5 and -5 KHz slide.
3. For more slide, replace D-54 with a Super Diode. By placing a Super Slide in series with the Super Diode, you can have as much as 30KHz slide.
4. For AM power, adjust VR6 for maximum.
5. For SSB power, adjust L26, L27, L28, L29, L36 for maximum peak power with a 1000 Hz. tone.
6. For SSB ALC, adjust VR7 for maximum, and for AM ALC, cut the collector of TR32.
7. "S" Meter adjust: VR1
Power Meter adjust: VR10
Squelch Range adjust: VR2

EXTRA FREQUENCIES:

Replace X4, 11.2858 MHz crystal with:

- 11.4358 - for 27.415 to 27.855
- 11.5858 - for 27.865 to 28.305
- 11.7974 - for 28.500 to 28.940
- 11.946 - for 28.950 to 29.390

CRAIG L-131, L-231

CLARIFIER & CHANNEL EXPANSION

SLIDER:

1. Cut the gray and green wires just to the left of the T/R relay and solder them together.
2. Cut the blue wire (next to the relay) and solder it to P/C board ground.
3. Remove C34 of the PLL circuit board and also replace CR4 with a Super Diode.

FREQUENCY EXPANSION:

1. At the top of the channel selector board lift the blue-white wire from the number 6 on the board and solder it to an on-off switch. Connect hook-up wire between the switch and number 6 on the channel selector board.
2. Lift the yellow-white wires from the number 4 on the board. Solder it to an on-off switch. Connect some hook-up wire between the switch and number 4 on the board.
3. Solder a wire to number 8 on the board and run it to an on-off switch. Solder a wire to number 7 on the board to the same switch.
4. For normal 1-40, switch 1 on, switch 2 on, switch 3 off. If the VCO L-3 does not go to 27.795, change the CR1 to a Super Diode.

FREQUENCY CHART

S-1 OFF, S-2 ON, S-3 OFF:

17 -27.485	29 - 27.615
18 27.495	30 27.625
19 27.505	31 27.635
20 27.525	32 27.645
21 27.535	33 27.655
22 27.545	34 27.665
23 27.575	35 27.675
24 27.555	36 27.685
25 27.565	37 27.695
26 27.585	38 27.705
27 27.595	39 27.715
28 27.605	40 27.725

S-1 ON, S-2 OFF, S-3 OFF:

33 27.415	37 27.455
34 27.425	38 27.465
35 27.435	39 27.475
36 27.445	

S-1 OFF, S-2 OFF, S-3 OFF:

33 27.735	37 27.775
34 27.745	38 27.785
35 27.755	39 27.795
36 27.765	

CRAIG L-131, L-231 (Cont'd):

FREQUENCY CHART

S-1 ON, S-2 ON, S-3 ON:

17	26.525	29	26.655
18	26.535	30	26.665
19	26.545	31	26.675
20	26.565	32	26.685
21	26.575	33	26.695
22	26.585	34	26.705
23	26.615	35	26.715
24	26.595	36	26.725
25	26.605	37	26.735
26	26.625	38	26.745
27	26.635	39	26.755
28	26.645	40	26.765

S-1 ON, S-2 OFF, S-3 ON:

33	26.775	37	26.815
34	26.785	38	26.825
35	26.795	39	26.835
36	26.805		

S-1 OFF, S-2 ON, S-3 ON:

17	26.845	29	26.975
18	26.855	30	26.985
19	26.865	31	26.995
20	26.885	32	27.005
21	26.895	33	27.015
22	26.905	34	27.025
23	26.935	35	27.035
24	26.915	36	27.045
25	26.925	37	27.055
26	26.945	38	27.065
27	26.955	39	27.075
28	26.965	40	27.085

PLL 01A FOR "A" CHANNELS WITHOUT SKIPS

Here's an oldie but goodie. Many of the older sets use this PLL 01A chip, so this information applies to many other sets. Also given is a switch diagram which will give all the "A" channels and pick up the RC channel skips on any PLL radio, both in band and when operating on extended channels. It comes in very handy on those sets which are hard to get 10KHz slide in.

KRACO KCB 2330A (Typical Cybernet Chassis)

Power adjust: L110, L109, L106, T103

AMC Modulation adjust: RV102 or cut collector of Q121 to eliminate AMC function altogether.

VCO adjust: (when necessary for higher frequencies) T101.

High Frequencies: Use center-off SPDT toggle switch. Common to Pin 9 of IC101 (PLL 01A), one terminal to pin 10, other terminal to Pin 11. See Universal "A" channel conversion for picking up all the A channels from 1-23 and on the new high frequencies.

FOR "A" CHANNELS USE PIN 16 FOR 10KHz
DROP OR RISE, PIN 9 FOR +5V, PIN 8 FOR
PC GROUND.

PLL 01A PINS VIEWED FROM BOTTOM
OF BOARD, FRONT OF RADIO.

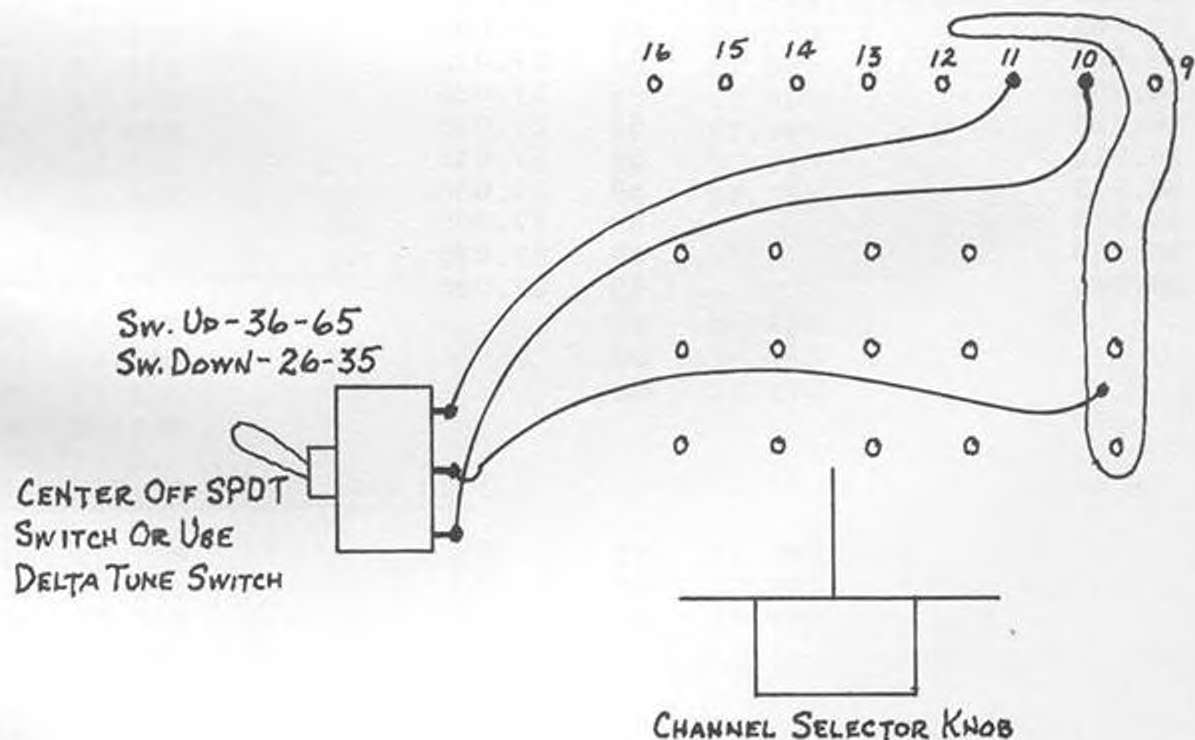

"A" CHANNEL MODIFICATION

(Applies to virtually all PLL radios)

This modification will allow almost any PLL radio to pick up all the "RC" channels, plus all the 1 channel skips when operating in the extended channel mode (above or below channels 1-40). Comes in very handy on those radios which are hard to modify for 10 KHz slide.

The PLL program pins on every PLL chip work by applying a voltage (or shorting to ground in some systems) to the various pins. We are all familiar with switching voltage to certain pins to get extra channels. What is really happening is that by applying a voltage to these pins; say pin 19 in a Upd 858 chip, for example, you are shifting your frequency up by 400 KHz. Other pins in the chip control lesser amounts of frequency. There is always one pin in all PLL radios which controls 10KHz of frequency movement. Apply a voltage to this pin and you go up 10KHz. If this pin already has an applied voltage, remove it and you go down 10KHz. This pin is alternately switched on and off for every other channel as you go from 1-40.

Depending on which RC channel you desire to reach, it will be necessary to drop down 10KHz to reach it, and on other RC channels with the same chip, it will be necessary to go up 10KHz to reach it.

You must locate the 10KHz pin on the chip in use first. This is ascertained by monitoring the voltage at the PLL pin. This pin is always one of the end pins in the series of wires connecting the chip to the channel selector switch. This voltage will go from 0 to a positive (usually about 5V) to 0 again on every other channel. Another way to identify this pin is that it is at the opposite end of the chip as the pins you switch to when modifying for high frequencies. Several common chip applications will be found at the end of this article.

You begin by isolating the 10KHz pin from the channel selector by cutting the foil near the pin and then bridge this cut with a 4.7K ohm resistor. Run a wire directly from the PLL pin to common of a center-off SPDT switch. The other terminals on the switch go to a positive voltage source (usually about 5V) and the other terminal to PC ground. This will allow either 10 KHz up or down. Depending on the channel you are on, you will be able to go up or down, but not both; remember the state of this pin alternates between high and low from channel to channel. If it is high, you flip the switch one way to take it low, and if the 10KHz pin is low, you flip the switch the other way to take it high. And of course, in the center off position you will have your normal channels.

PLL 01A FOR "A" CHANNELS (Cont'd):

SPECIFIC APPLICATIONS

Upd 858 chips:

10 KHz - pin 13
+5V - near pin 24
P.C. ground - pin 22 or 23

UNIDEN MB8719 Chips:

10 KHz pin - pin 16
+8V - pin 9
P.C. ground - pin 18

CYBERNET PLL 01A Chips:

10 KHz - pin 16
+5V - pin 9
P.C. ground - pin 8

CYBERNET PLL 02A Chips:

10 KHz - pin 15
+5V - pin 8
P.C. ground - pin 16

TYPICAL APPLICATION

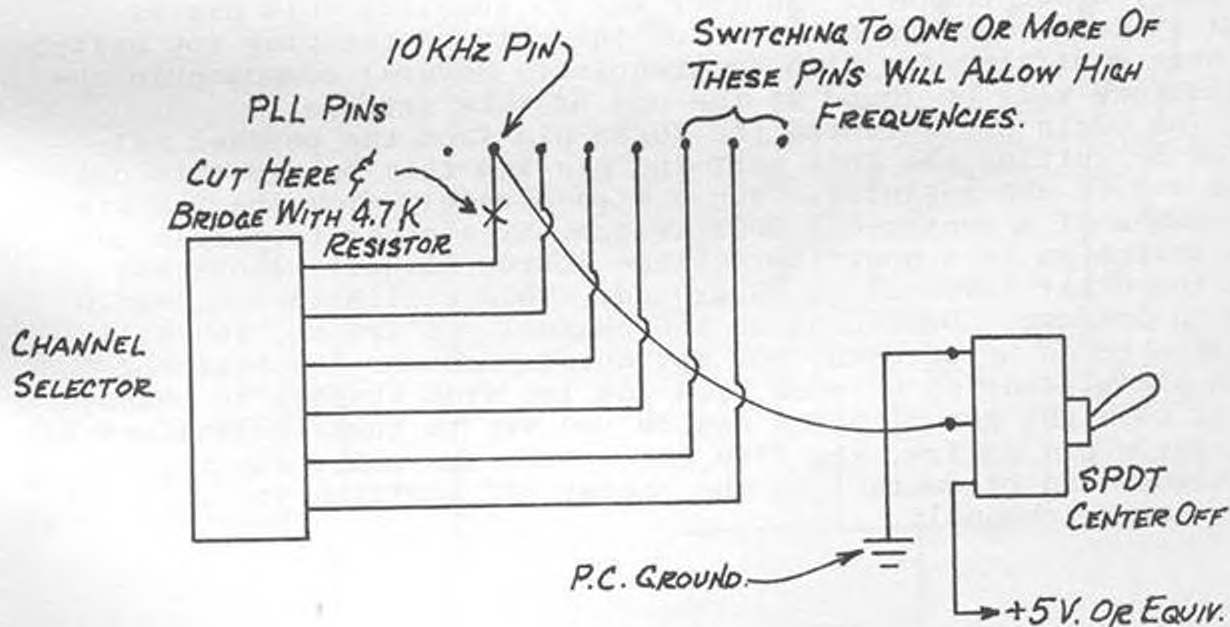

DAK IX

MODIFICATION UPDATE

FREQUENCY MODIFICATION:

- (1) Remove the cabinet and top PLL cover.
- (2) Cut the green wire connected to Pin 6 of the PLL block.
- (3) There are two choices of switching that can be used. The first, shown in Figure "B", uses a DPDT center off toggle switch to allow access to 41 - 48 and 23 channels below 1. For 49 - 56, use the rotary switch conversion shown in Figure "C".

MODULATION:

Adjust the ALC, located just behind the PLL block, fully clockwise.

POWER INCREASE:

Use a DPDT switch, (Fig. "E") and wire it to points "A", "B", and "C" on the XMIT-MOD. board as shown in Figure "F".

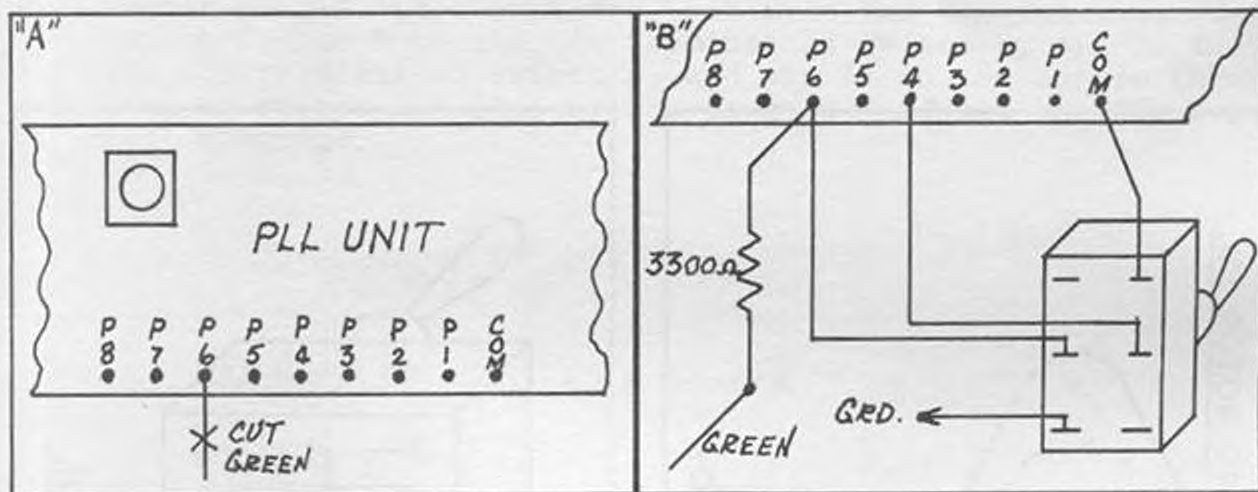

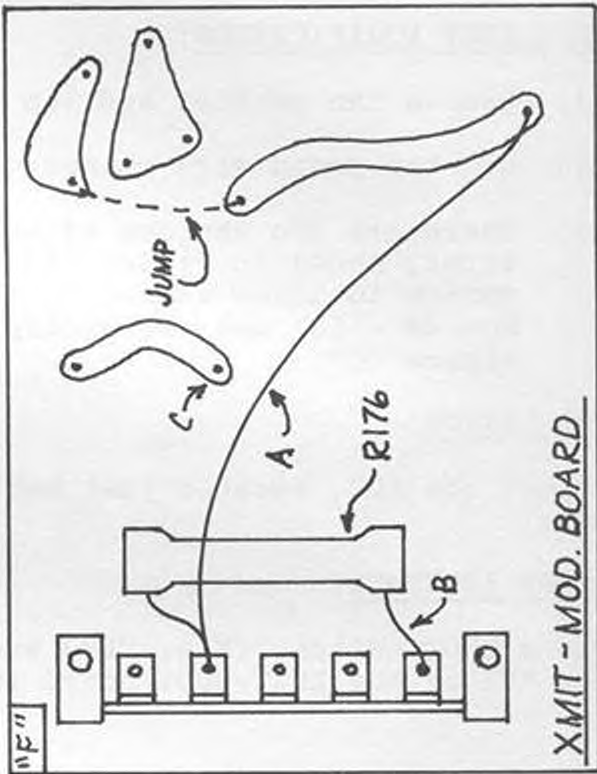
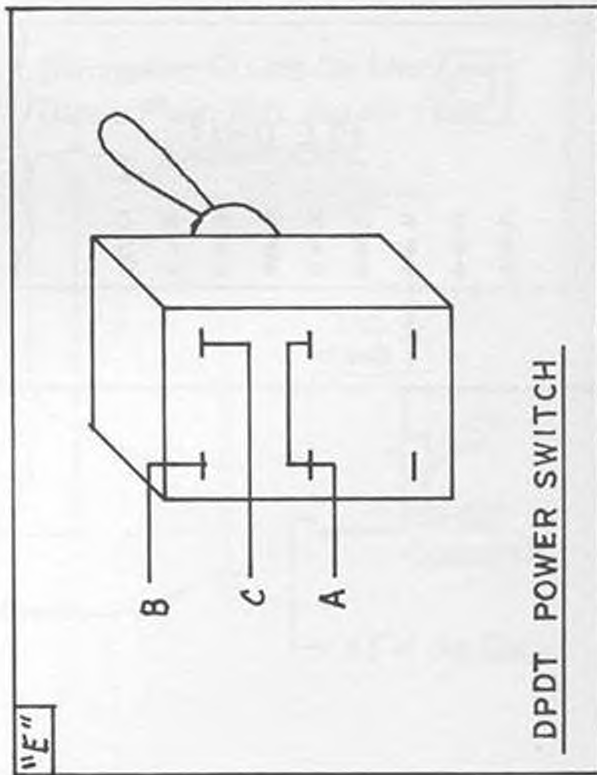
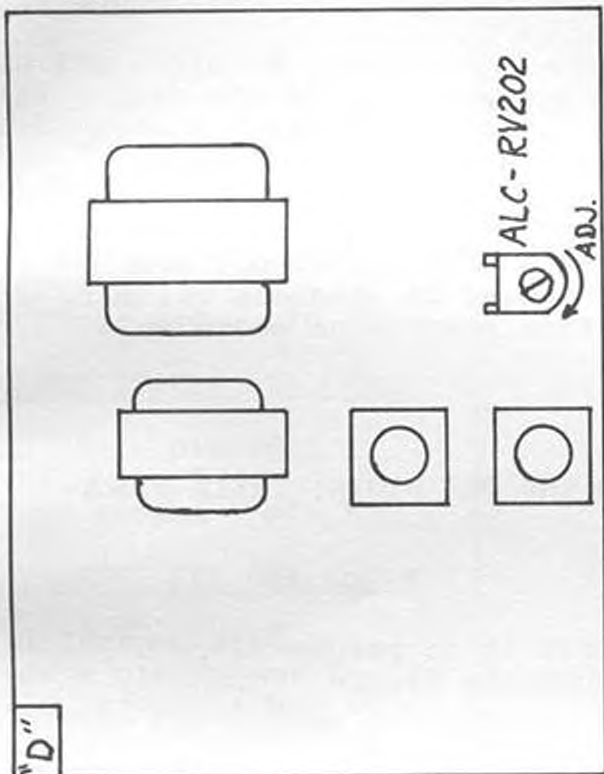
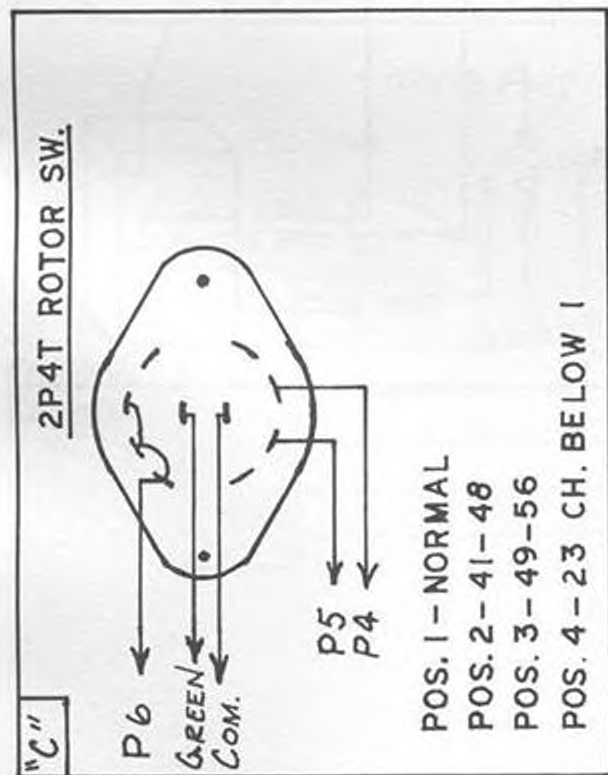

SEARS ROADTALKER 40

MODEL #934-3827

CHANNEL EXPANSION AND SLIDE

1. Remove R303. Unsolder the green wire from the clarifier control at the printed circuit board and connect to 8V regulated, which is found at point BB. There is a red wire soldered there. Solder the green wire to the red wire. Follow the black wire from the clarifier to where it is connected to the printed circuit board. Unsolder it and reconnect it to ground. The unit will now slide +2 and -2KHz. For +5 and -5 KHz, remove CT302 and CT301, D304 and D306, and install super diodes in place of D304 and D306.
2. For maximum AM modulation, connect the anode of an 1N914 diode to the base of Q405 and ground the cathode.
3. AM power - adjust RT602. ALC - adjust RT701. Adjust L702 and L708 with a 1000 Hz tone for peak AM. Note: RT602 is 13.8 V. regulator.
4. Cut the printed circuit trace at pin #9 and isolate the pin. Connect a 6" piece of wire to pins 8, 9, 10, and 11. Connect a 6" piece of wire to pin 1. You must have 3 switches; a single pole, double throw, center off; and two (2) single pole, single throw toggle switches. Connect pin #1 to the common of all three switches, pin 8 to the top terminal of switch C, pin 9 to the top terminal of switch B, pin 10 to the top terminal of switch A, and pin 11 to the bottom terminal of switch A. (See switch diagram) Adjust the VCO for full coverage.

REMOVE PIN 8 FROM 4.8V SOURCE

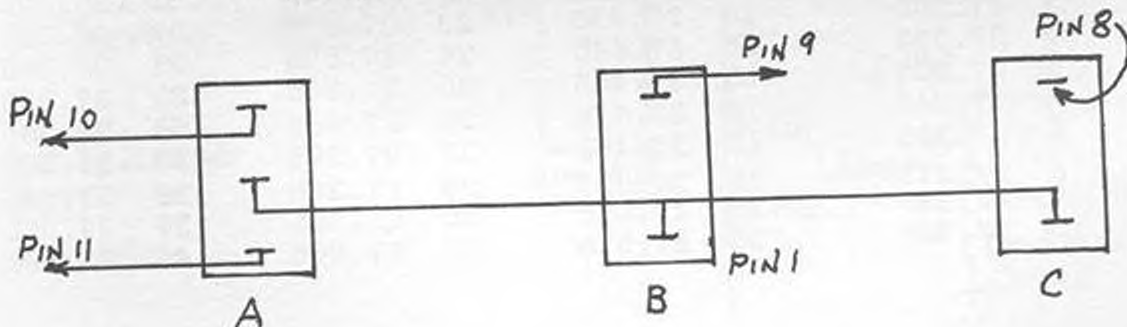

LOW FREQUENCIES

SWITCH A UP(SPDT), SWITCH B ON, SWITCH C ON:

<u>CHANNEL</u>	<u>FREQUENCY</u>	<u>CHANNEL</u>	<u>FREQUENCY</u>
1	26.485	21	26.575
2	26.495	22	26.585
3	26.505	23	26.615
4	26.525	24	26.595
5	26.535	25	26.605
6	26.545	26	26.625
7	26.555	27	26.635
8	26.575	28	26.805
9	26.585	29	26.815
10	26.595	30	26.825
11	26.605	31	26.835
12	26.625	32	26.845
13	26.635	33	26.855
14	26.485	34	26.865
15	26.495	35	26.875
16	26.515	36	26.885
17	26.525	37	26.895
18	26.535	38	26.905
19	26.545	39	26.915
20	26.565	40	26.925

SWITCH A CENTER/SWITCH B ON:

1	27.605	11	27.725	21	27.855	31	27.955
2	27.615	12	27.745	22	27.865	32	27.965
3	27.625	13	27.755	23	27.895	33	27.975
4	27.645	14	27.765	24	27.875	34	27.985
5	27.655	15	27.775	25	27.885	35	27.995
6	27.665	16	27.795	26	27.905	36	28.005
7	27.675	17	27.805	27	27.915	37	28.015
8	27.695	18	27.815	28	27.925	38	28.025
9	27.705	19	27.825	29	27.935	39	28.035
10	27.715	20	27.845	30	27.945	40	28.045

SWITCH A DOWN/SWITCH B OFF:

1	27.285	11	27.405	21	27.535	31	27.315
2	27.295	12	27.425	22	27.545	32	27.325
3	27.305	13	27.435	23	27.575	33	27.335
4	27.325	14	27.445	24	27.555	34	27.345
5	27.335	15	27.455	25	27.565	35	27.355
6	27.345	16	27.475	26	27.585	36	27.365
7	27.355	17	27.485	27	27.595	37	27.375
8	27.375	18	27.495	28	27.285	38	27.385
9	27.385	19	27.505	29	27.295	39	27.395
10	27.395	20	27.525	30	27.305	40	27.405

SEARS ROADTALKER 40, #934-3827 (Cont'd):

SWITCH A UP/SWITCH B OFF:

1	27.125	11	27.245	21	27.215	31	27.475
2	27.135	12	27.265	22	27.225	32	27.485
3	27.145	13	27.275	23	27.255	33	27.495
4	27.165	14	27.125	24	27.235	34	27.505
5	27.175	15	27.135	25	27.245	35	27.515
6	27.185	16	27.155	26	27.265	36	27.525
7	27.195	17	27.165	27	27.275	37	27.535
8	27.215	18	27.175	28	27.445	38	27.545
9	27.225	19	27.185	29	27.455	39	27.555
10	27.235	20	27.205	30	27.465	40	27.565

SWITCH A CENTER/SWITCH B OFF/SWITCH C OFF:

Normal 40 channels

SWITCH A DOWN/SWITCH B ON:

1	27.765	11	27.885	21	27.855	31	28.115
2	27.775	12	27.905	22	27.865	32	28.125
3	27.785	13	27.915	23	27.895	33	28.135
4	27.805	14	27.765	24	27.875	34	28.145
5	27.815	15	27.775	25	27.885	35	28.155
6	27.825	16	27.795	26	27.905	36	28.165
7	27.835	17	27.805	27	27.915	37	28.175
8	27.855	18	27.815	28	28.085	38	28.185
9	27.865	19	27.825	29	28.095	39	38.195
10	27.875	20	27.845	30	28.105	40	28.205

SEARS ROADTALKER 40

934-38310700

For extra channels, refer to Secret CB, Volume 6, page 28 for the Roadtalker 934-38270700. For extra low, use 12.220 MHz crystal.

CLARIFIER

YELLOW WIRE To POINT 6

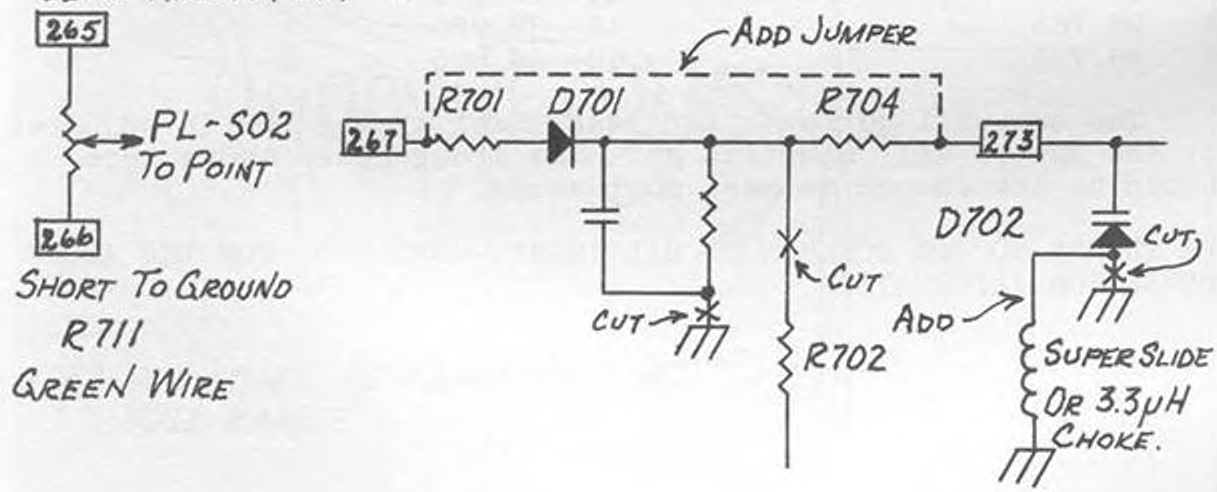

CPI 2000 BASE
LOW FREQUENCY CONVERSION

Locate L7408 and K7402 IC's and cut the P/C trace from pin 8 on L7408 to K7402. Add a switch to make and break the connection. This will give you lower frequencies. For high frequencies follow the 80 channel conversion given in Volume 3, page 25.

WITH CIRCUIT OPEN:

17	26.665	29	26.795
18	26.675	30	26.805
19	26.685	31	26.815
20	26.705	32	26.825
21	26.715	33	26.835
22	26.725	34	26.845
23	26.755	35	26.855
24	26.735	36	26.865
25	26.745	37	26.875
26	26.765	38	26.885
27	26.775	39	26.895
28	26.785	40	26.905

WITH THE SWITCH OFF AND THE UPPER FREQUENCY SWITCH ON, THE DISPLAY READS OUT FROM 66 - 79:

66	26.665	78	26.785
67	26.675	79	26.795
68	26.685	40	26.905
69	26.695	41	26.915
70	26.705	42	26.925
71	26.715	43	26.935
72	26.725	44	26.945
73	26.735	45	26.955
74	26.745	46	26.965
75	26.755	47	26.975
76	26.765	48	26.985
77	26.775	49	26.995

The set will go lower and read lower if the VCO is adjusted, but the uppers will start to go. The frequencies shown here should be low enough to meet most needs.

OUR THANKS TO JOE SCHLEIN OF BALTIMORE, MARYLAND, FOR THE ABOVE CONVERSION INFORMATION.

SUPERSCOPE AIRCOMMAND CB340

90+ CHANNELS

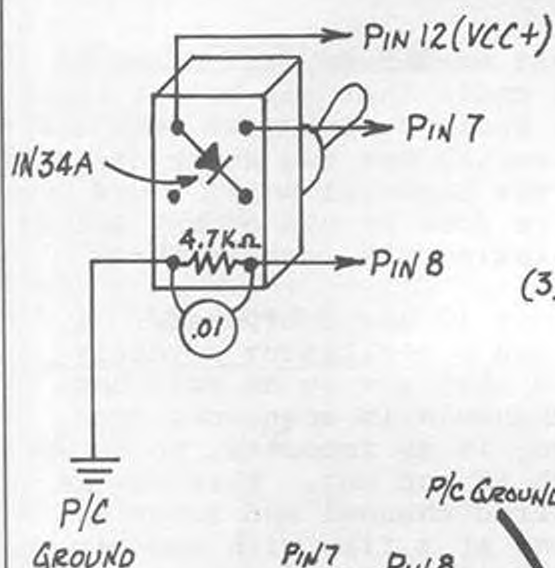

- (1) LIFT 861 PLL CHIP OUT OF ITS SOCKET & LIFT PINS 14 & 24 OUT OF THE WAY.
- (2) REINSERT CHIP INTO THE SOCKET & ATTACH 4.7 KΩ RESISTORS TO PINS 14 & 24 & CONNECT OTHER SIDES TO GROUND.
- (3) WIRE DPDT TOGGLE SWITCH AS SHOWN.

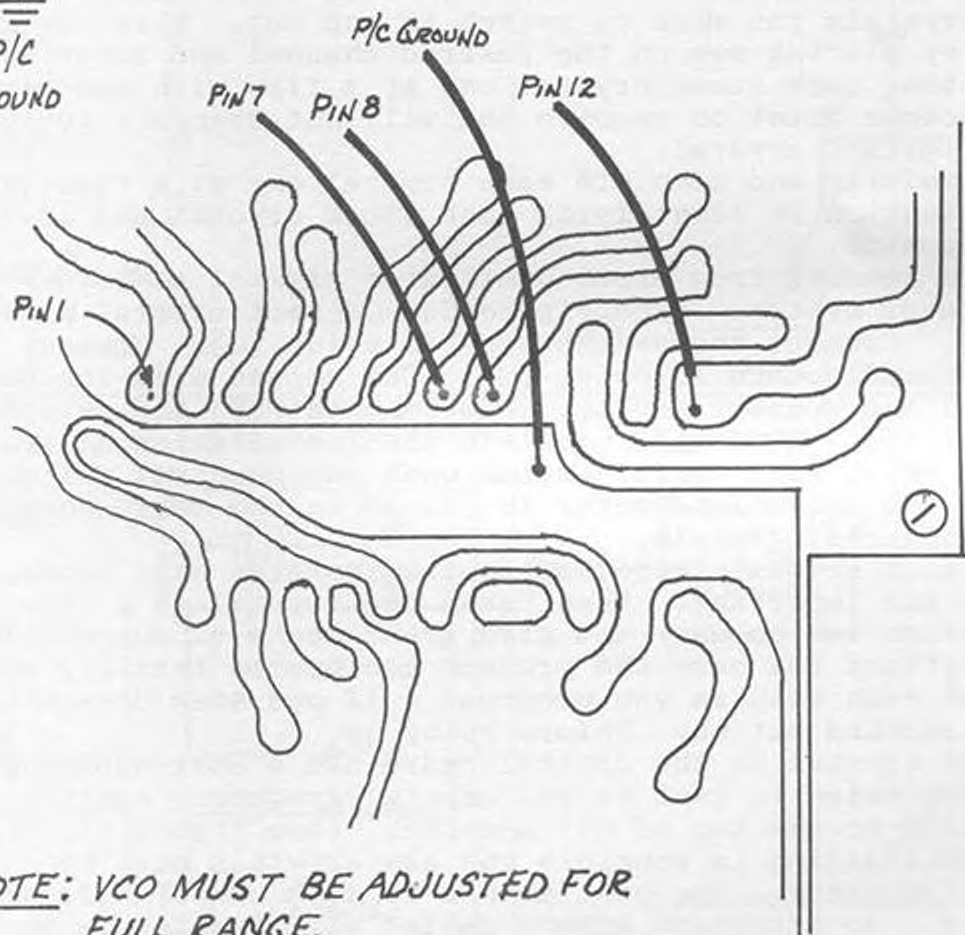

NOTE: VCO MUST BE ADJUSTED FOR FULL RANGE.

RELAY CRYSTAL SWITCHING

(FOR CRYSTAL SYNTHESIZED RADIOS)

INSTALLATION:

It is important to first note that each 6 crystal board is made up of three individual 2 crystal units that may be cut apart to meet individual requirements. The basic function of each unit is to switch in two new crystals and switch out two stock crystals as +12 volts is applied to the relay via terminal point B and terminal point A is grounded. This can be done by use of any unused stock switch or by installing a new single pole, double throw toggle switch.

Most crystal synthesized radios use 10 basic crystals. 4 mixer crystals (usually in a group), and 6 oscillator crystals also in a group. It is the group of 6 that are to be switched.

Each single crystal replaces 4 channels in sequences from 1-4, 5-8, 9-12, 13-16, etc. Therefore, it is important to determine which crystals you wish to switch in and out. This can be done easily by placing set on the desired channel and removing or disconnecting each stock crystal one at a time with the set on. When unit becomes quiet on receive and will not transmit you have located the correct crystal.

Work carefully and complete each crystal one at a time, paying close attention to identifying each stock crystal and its corresponding wire.

Cut wire leading from stock oscillator crystal to rotary channel selector switch. (See Figure C) Connect crystal side to point (F). Connect the switch side to point (C). Connect wire from crystal ground to point (G). Cut second wire for next stock crystal and connect crystal side to point (E) and switch side to point (D). This will complete the installation of two new crystals which will replace stock ones when control switch is turned on and channel selector is placed in the corresponding channel of replaced crystals.

A typical 6 crystal installation incorporates many wires, all delicate and important. When taken one crystal at a time, the installation can be easy and give great sense of accomplishment. But without due care the project can become terribly confusing. Test each step as you progress. If one step does not work, stop and find out why before going on.

Each new crystal on the crystal board has a corresponding trim capacitor which is used to set crystal frequency exactly by turning slot in the top of CX¹ and CX². (See Figure 1).

Once installation is complete the new crystals must be checked for frequency. The best method is with use of a frequency counter. An alternate method called zero beating is to place a second set near by tuned to the same frequency and

RELAY CRYSTAL SWITCHING (Cont'd):

turned on. By keying the modified radio and tuning crystal adjusting capacitors until feed back tone is at zero or lowest point and "S" meter reading is at maximum point, frequency is set. This method is not exacting, nor acceptable for maximum performance, but will suffice on most AM type transmitters.

TERMINAL IDENTIFICATION:

- A = Ground
- B = +12V
- C = SW₁ output
- D = SW₂ output
- E = SW₂ input
- F = SW₁ input
- G = Crystal ground

COMPONENT IDENTIFICATION:

- CR₁, CR₂ = Crystals
- CX₁, CX₂ = 5 - 30 pf capacitors
- D₁ = 1N4001 diode
- Relay = DPDT - 12V

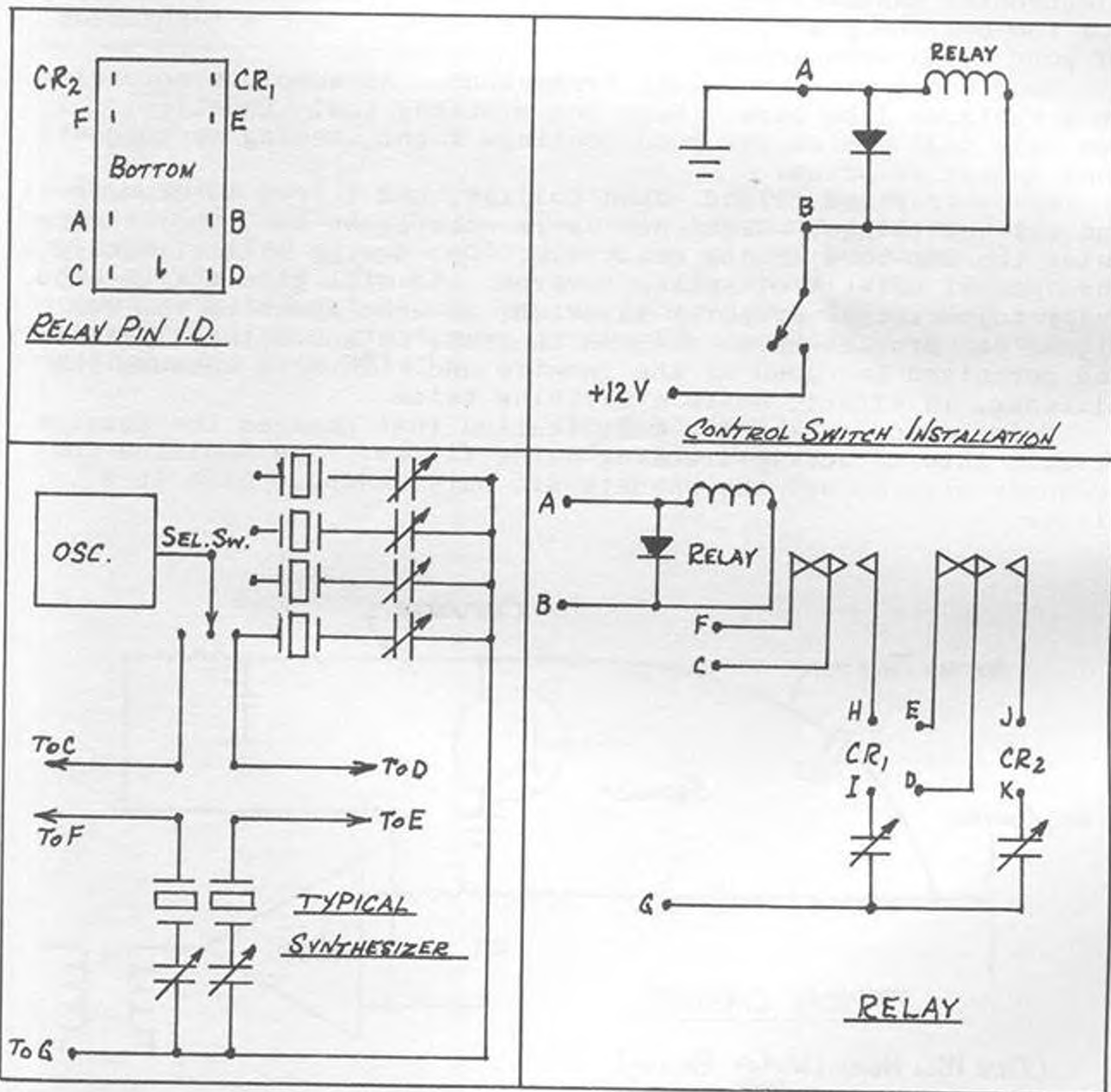

LETTER FROM A FRIEND

IN THE THREE YEARS WE HAVE BEEN PUBLISHING SECRET CB, WE HAVE RECEIVED A LOT OF LETTERS FROM READERS, SOME THROWING ROTTEN TOMATOES, AND OTHERS SENDING US A LOT OF PRAISE FOR THE WORK WE HAVE BEEN DOING. ONE OF THE LATTER WE WOULD LIKE TO SHARE WITH YOU.

Dear Rod -

Congratulations on the success of Secret CB. I've been fooling around with CB since 1967 (off & on) but it wasn't until a couple of years ago that I got my second-class ticket. I did some tech work at a local CB shop, but got tired of splitting my repair work money (which was 90% of the store's income) with the owner, so I quit. Since then, a friend and I have established our own modification/repair business and most of the time we've been covered up with work. Both of us have worked for a local electronics manufacturer as electronic technician/defect analysts for the past 6+ years, and this has given our shop a reputation of good clean workmanship.

Your books are absolutely tremendous. An absolute necessity to a business like ours. Very few mistakes too! Excellent! I can only tell you of the good feelings I got, seeing my suggestions appear in print.

My partner and friend, John Collins, and I love to experiment and try new things. Right now we're working on an "echo chamber" using the SAD-1024 analog delay I.C. Our design will eliminate the "barrel effect" of spring reverbs, and will give a true echo, fully adjustable. Properly adjusted, an echo added to the audio signal can provide up to a +3 DB increase in audio intelligibility and perceived loudness at the receive end. This is because the listener, in effect, hears everything twice.

We've also developed a modification that changes the squelch circuit into an active-tracking noise filter. The modification is quite simple, but the results are outstanding. Give it a listen.

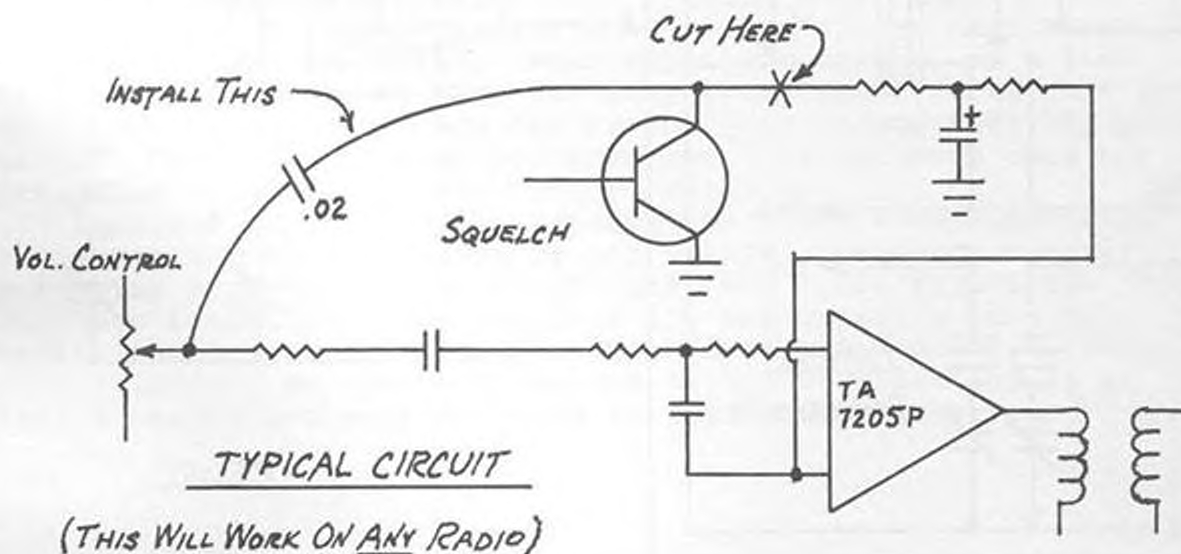

LETTER FROM A FRIEND (Cont'd):

Also, how about FM? Wouldn't a mode selector that read, "AM-LSB-FM" look really neat. Well, without giving away any of our "secrets", wouldn't it be nice if an audio signal could somehow be converted into a frequency-modulated voltage and injected at the clarifier input on a SSB rig. Presto, instant FM on 26-28 MHz. (It works too - legal, I think).

You might also want to try this expanded version of the modulation booster:

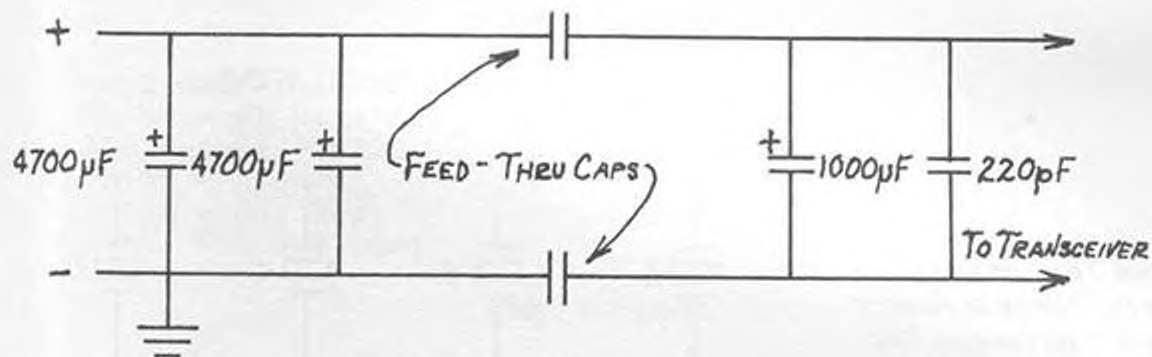

This works really good with linears. 220pf helps eliminate "squealing" from RF feedback. Be sure to ground case on feed-thru caps. (Also great for hi-power car stereo boosters.)

As always, feel free to use any of the above info. Keep up the good work and watch out for the Federales. In my mind your books are filling a great need in the CB community. Continued good luck, and good DXin' to yah.

Jim Schleitwiler
Universal Mobile

HINTS & KINKS

ELECTRONIC CRYSTAL SWITCHING

*Correction
Vol 10
Page 72,74,75*

OOPS WE GOOFED! IN VOLUME 8, PAGE 17, WE NEGLECTED TO MENTION THAT YOU WILL NEED AN OSCILLATOR CIRCUIT TO SWITCH THE CRYSTALS MENTIONED FOR EXTRA FREQUENCIES. OUR APOLOGIES FOR ANY INCONVENIENCE THIS OVERSIGHT MAY HAVE COST YOU.

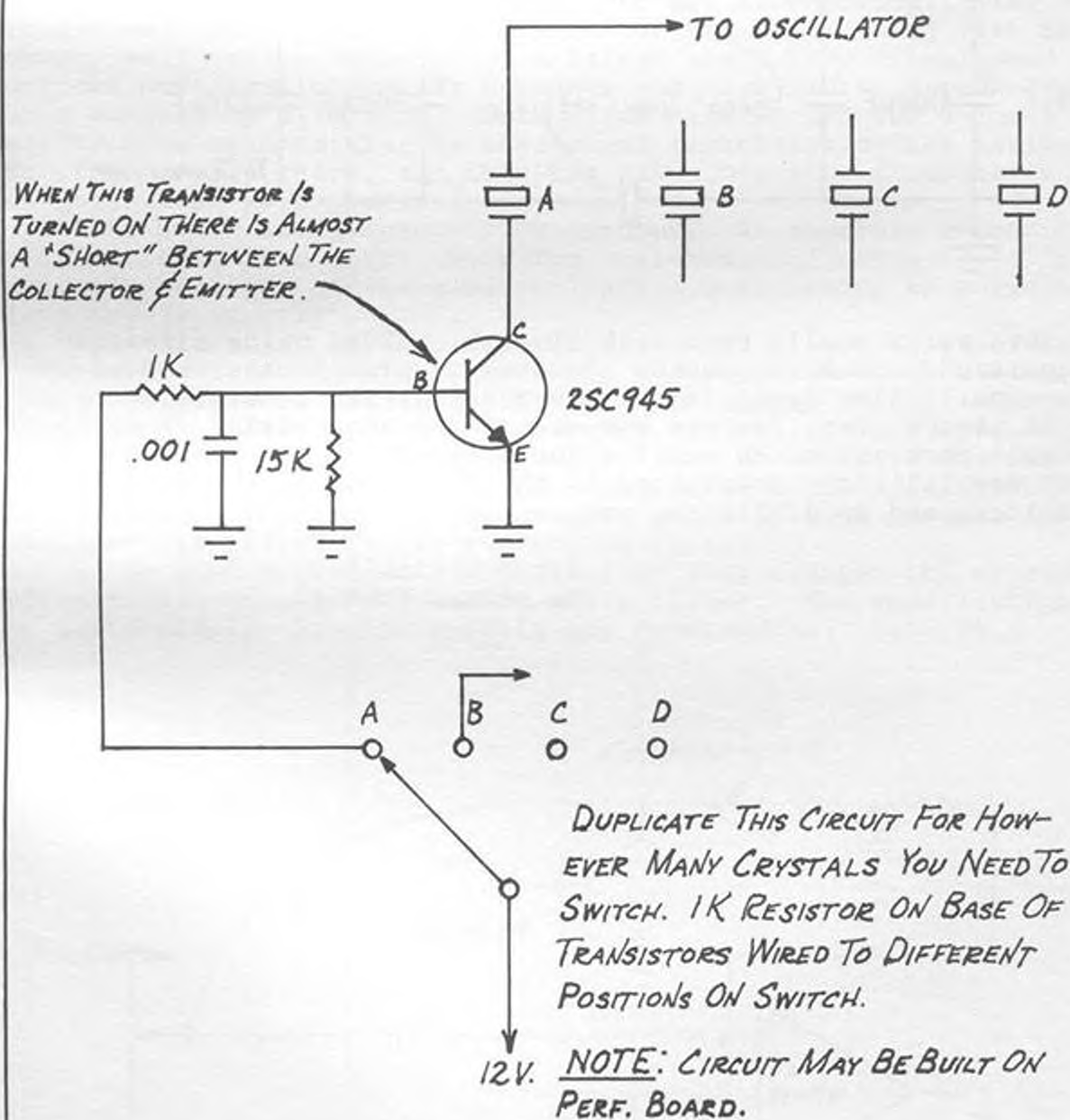

SPECIFIC RADIO TUNE-UPS

ALARON B-4075

TX: PEAK - L-302, L-303, L-304, L-305, L-306, L307, L-308, L-309
 RV219 - Mic. Gain Output
 Pull - D-202 (AMC Defeat)
 RV301 - RF Mtr. adj.

RX: RV101 - Sq. rng.
 RV102 - S Mtr. adj.

ALARON B-4900

TX: Peak out - L-401, L-403, L-406
 VR402 - RF Mtr. Cal.
 AMC Defeat - C228

RX: VR102 - AGC
 VR301 - Sq. Rng.
 VR401 - S Mtr. Cal.

ALARON B-5050A

TX: Peak - L-302, L-303, L-304, L-305, L-306, L-307, L-308, L-309
 RV407 - Voltage Adj. (13.8 VDC to D.C. Gnd.)
 RV219 - Mic Gain
 RV301 - RF Mtr. Adj.

RX : RV101 - Sq. Rng.
 RV102 - S Mtr. adj.

Change - R203: 4.7 K to 2.7 K resistor
 Pull - Q202, Q206, Q208, D204, D202, C227

COBRA 77X

TX: Peak - L-208, L-209, L-210, L-211, L-212, L-214
 VR207 - AMC Defeat, C-270
 VR206 - RF Mtr. Adj.

RX: VR201 - AGC
 VR204 - Sq. Rg.
 VR205 - S Mtr. Adj.

COLT 1200 (EXCALIBUR)

(This radio has best RX filtering of any we have seen!)

Changes to unit: Change insulators on Q9, Q10, and all other transistors with "91 day wonders" to mica TO-220!

- (2) Change C-1 in P/S 2.200 mf to 5,000 mf/50V.
- (3) Change C-2 in P/S 100mf to 220 mf/50V.
- (4) If R-302 not in unit, put in. It should be 270 ohm, $\frac{1}{2}$ W - saves on bulb life.
- (5) Add 300 ohm (need 2 resistors) to signal meter light in series. Also to RF/SWR meter light.
- (6) Take D-701 out of circuit.
- (7) Change final to 2SC1307.

(NOTE): Do not exceed 10W in AM mode, dead key!

SPECIFIC RADIO TUNE-UPS (Cont'd):

COLT 1200 (Excalibur) (Cont'd)

TX. ADJ.: Max.: T-4, T-5, T-6, L-11, L-7, L-13
RV4, RV5: Carrier Balance
RV-1: Final Bias
RV-11: SSB Mic Gain
RV-2: SSB RF ALC (Do not exceed 18 watts!)
RV-12: AM AMC
VR-9: AM Power (Do not exceed 10W dead key!)
RV-3: RF Meter (AM)

RX. ADJ.: RV-8: AGC
RV-9: AM Sq. Rng.
RV10: SSB Sq. Rng.
RV-6: AM S Mtr.
RV-7: SSB S Mtr.

NOTE: RV501: SWR Meter cal.

G.E. 3-5811B

TX. ADJ.: Peak: L-5, T-3, T-4, L-7, L-11, L-12
RV2 - AMC (Defeat C-96)
RV4 - RF Mtr. Adj.

RX. ADJ.: RV1 - Sq. Rng.
RV3 - S Mtr. Adj.

G.E. 3-5821A

TX. ADJ.: Peak : L-901, L-903, L-905
VR10 - AMC (Defeat, R-554)
VR11 - RF Mtr. Adj.
VR12 - AWI (connect 250 ohm 5W across antenna jack,
adjust til light comes on!)

RX. ADJ.: VR-3 - AGC
VR-1 - RF Gain Rng.
VR-5 - Sq. Rng.
VR-7 - Priority Sq. Adj.
VR-6 - S Mtr. Adj.

G.E. 3-5825A

TX. ADJ.: Peak - (T-4 on 40 USB; T-5 on 1 USB), peak following on
19 USB - T-11, RV11, T-6, L-7, L-11, L-13.
RV-1 - Final Bias
RV4,5- Balance
RV2 - SSB Power
VR-5 - AM Power
RV12 - AMC
RV-3 - Power Mtr. Adj., A.M.
RV501- AWI

SPECIFIC RADIO TUNE-UPS (Cont'd):

RX. ADJ.: RV-8 - SSB AGC
RV-9 - AM Sq. Rng.
RV10 - SSB Sq. Rng.
RV-6 - AM S Mtr.
RV-7 - SSB S Mtr.

G.E. 3-5875A
(SUPERBASE)

1. Frequency Conversion & slide modification identical to SBE-LCBS-4 (See Secret CB, Vol. 7, pp. 30-33).

TX. ADJ.: Peak: T-204, T-205, T-3, T-209, L-209, L-212, L-214

RV1, RV2 - Carrier Balance
RV207- Driver Bias
RV206- Final Bias
RV-3 - SSB Mod. Gain
RV20 - SSB RF ALC
RV-9 - AM AMC
RV-1 - Speech Compressor
RV11 - Mod., Meter Cal.
RV202- RF Meter Cal.
RV205- SWR meter Cal.
RV203- AWI cal.
VR10 - AM Power

RX. ADJ.: RV10 - RF Gain (AM)
RV-6 - SSB AGC
RV-7 - AM Sq. Rng.
RV-8 - SSB Sq. Rng.
RV-5 - AM S Mtr. Cal.
RV-4 - SSB S Mtr. Cal.

G.M. 4145

TX. ADJ.: Peak: T-5, T-6, T-7, T-8, L-3, L-4, L-6
Pull: Q-10

RX. ADJ.: R202 - S Mtr. Adj.

JC PENNY 981-6204 (981-7461)

TX. ADJ.: Peak: Very carefully for maximum modulation vs. power:
T-3, T-4, L-7, L-11, L-12; adjust L-7 clockwise,
L-12 counterclockwise.

RV-2 - AF ALC
RV-4 - RF Mtr. Adj.
Pull: Q14, D11, C96
Change: R59 to 680 ohm, 1/2 watt

RX. ADJ.: RV-1 - Sq. Rng.
RV-3 - S Mtr. Adj.

MIDLAND 76-863

TX. ADJ.: Peak: L-5, T-3, T-4, L-7, L-11, L-12
RV-2 - AMC (Defeat, C-96)
RV-4 - RF Mtr. Adj.
RV521- AWI Adj.
RX. ADJ.: RV-1 - Sq. Rng.
RV-3 - S Mtr. Adj.

MIDLAND 77-838

TX. ADJ.: Peak: L-5, T-3, T-4, L-7, L-11, L-12
RV-2 - AF ALC (Defeat, C-96)
RV-4 - RF Mtr. Adj.
RX. ADJ.: RV-1 - Sq. Rng.
RV-3 - S Mtr. Adj.

MIDLAND 77-865

TX. ADJ.: Peak: L-16, L-15, L-12
VR-5 - AMC
VR-4 - RF Mtr. Adj.
Pull: D21
RX. ADJ.: VR-1 - AGC
VR-2 - S Mtr. Adj.
VR-3 - Sq. Rng.

MIDLAND 77-899

TX. ADJ.: Peak: L-5, T-3, T-4, L-7, L-11, L-12
RV-2 - AMC (Defeat, C-96)
RX. ADJ.: RV-1 - Sq. Rng.

PACE 8046

TX. ADJ.: Peak: L-6, L-7, L-8, L-10, L-13, L-14
R302 - AMC (Defeat, C-68)
R301 - RF Mtr. Adj.
R305 - AWI
RX. ADJ.: R303 - Sq. Rng.
R304 - S Mtr. Adj.

MIDLAND 79-900

TX. ADJ.: Peak: L-27, L-28, L-29, L-30, L-31, L-33, L-36, L-39
VR-5, VR-4 - Carrier Balance
VR-8 - Driver Bias
VR-9 - Final Bias
CT-4 - SSB ALC (Do not exceed 16 watts!)
VR-6 - AM AMC

SPECIFIC RADIO TUNE-UPS (Cont'd):

VR-7 - AM Power (Do not exceed 10 watts dead key!)
VR10 - RF Power Mtr. (AM)
RX. ADJ.: VR-2 - Sq. Rng.
VR-1 - S Mtr.

PANASONIC CR-B4747EU (AM-FM-CB).

TX. ADJ.: Peak: T-904, T-903, T-902, L-905, L-903
VR901- Power Output Adj. (Unit has 15W Final!)
VR902- Modulation Gain (output)
VR903- Modulation Adj.

PACE 8155

TX. ADJ.: Peak: L-401, T-401, T-402, T-403, L-404, L-407, L-408,
C-432
R310 - AMC (Defeat, C-313)
R425 - RF Mtr. Adj.
RX. ADJ.: R549 - Sq. Rng.
R544 - S Mtr. Adj.

PEARCE SIMPSON TIGER 40A

TX. ADJ.: Peak - L-103, L-104, T-102, T-103, L-106, L-109, L-110
RV102- AMC (Defeat, C-209)
RV104- RF Mtr. Adj.
RX. ADJ.: RV101- Sq. Rng.
RV103- S Mtr. Adj.

PRESIDENT ANDREW J.

TX. ADJ.: Peak: L-18, L-17, L-14, L-10
VR-5 - AMC (Defeat, C-70)
VR-3 - RF Mtr. Adj.
RX. ADJ.: VR-2 - IF Gain
VR-4 - Sq. Rng.
VR-1 - S Mtr. Adj.

PRESIDENT OLD HICKORY

TX. ADJ.: Peak: L-14, L-13, L-12, L-11, L-9
VR-5 - AMC (Defeat, R-75)
VR-4 - RF Mtr. Adj.
RX. ADJ.: VR-1 - Volume Rng.
VR-2 - S Mtr. Adj.
VR-3 - Sq. Rng.

REALISTIC TRC-421A (21-1502)

VR-5 - S Mtr.
VR-1 - RF Gain
VR-2 - Sq. Rng.
Mod. Limiter Disable: Cut D-16 & D-17
Peak: T-12, T-13, L-3, L-6 ONLY

NOTE: Meter will peg out transmit! Pull R-69 (5.6 K);
put 10K variable in place and adjust meter!

REALISTIC TRC-424

Frequency modification identical to TRC-431, which you will
find in Secret CB, Vol. 7, pp. 23, 24.

REALISTIC TRC-440

TX. ADJ.: Peak: L-102, L-104, L-106
Pull: D109
Pull: R183, put 20K variable in place. Use as RF Mtr adj.
RX. ADJ.: VR-1 - IF Gain
VR-4 - Sq. Rng.
VR-6 - S Mtr. Adj.

Change C-204 in Power Supply to 3,300 mfd/50VDC.

REALISTIC TRC-457, TRC-458, TRC-449

Frequency Modification & Slider Modification on Pg. 51,
Secret CB, Vol. 3 is correct and identical for installation, per
TRC-449.

Changes in TRC-457, TRC-458, TRC-449: (Immediately) all "91
day wonders" (thick insulators on drivers, finals, voltage regula-
tors, etc.) should be changed to TO-220 mica insulators, about
40¢ each at Radio Shack. Cheap insurance.

Changes in TRC-457, TRC-458: Power Supply Filter capacitor
(C-304; 3,300 mfd/25VDC). Have had to change 7 out of 10. Went
to 5,000 mfd/50VDC and had no more problems.

Changes in TRC-457, 458, 449: If you are going to run AM
power at maximum, change TR-25 to a GE-28 or ECG-186. Also change
D-26 zener diode to a 5 watt, and C-102 to a 25V, also R-161 to
2 watt carbon resistor.

NOTE: If you are using an Expander 500 that has been "mod-
ified, change R-84 to 2.7K ohm.

TX. ADJ.: NOTE: Broadband the chassis according to Secret CB,
Vol. 7, pg. 45.
Peak: L-39, L-37, L-32, L-30, CT7 (Use USB mode)
RT301- Voltage adj.; 13.8VDC max.
VR17 - LED Brilliance
VR15 - Driver Bias
VR16 - Final Bias

SPECIFIC RADIO TUNE-UPS (Cont'd):

VR-4 - Balance
VR-8 - AM Pwr Adj.
VR6, VR7- Mic Gain & AM AMC
VR12 - Power Meter Adj.
RX. ADJ.: VR-5 - AM RX GAIN
VR-2 - RF Gain
VR-3 - Sq. Rng.
VR-1 - S Mtr. Adj.

REALISTIC TRC-462 (21-1528)

VR-1 - Sq. Adj.
VR-2 - AMC Adj.
VR-3 - RF Power Adj. (Don't exceed 75% of finals pwr
rating at dead key.)
VR-4 - RF Mtr. Adj.
VR-5 - S Mtr. Adj.
Mod. Limiter Disable: C-60, 1mfd/50V, located to left
of 1000 mfd. capacitor.

RCA 14T270

TX. ADJ.: Peak: L-5, T-3, T-4, L-7, L-11, L-12
RV-2 - ALC (Defeat, C-96)
RV-4 - RF Panel Meter Adj.
RV501- SWR Mtr. Cal.
RX. ADJ.: RV-1 - Sq. Rng.
RV-3 - S Mtr. Adj.

SBE 44CB (MALIBU 40)

TX. ADJ.: Peak: T-301, L-302, L-303, T-302, L-305, L-308, L-309
R226 - AMC (Defeat, CR-33)
R319 - RF Mtr. Adj.
RX. ADJ.: R118 - Sq. Rng.
R128 - S Mtr. Adj.

SBE LAND COMMAND LCM-5

TX. ADJ.: Max. out: L-10, L-11, L-12, L-15
VR-6 - AMC (Defeat, pull C-49)
VR-5 - TX. Power Mtr.
RX. ADJ.: VR-7 - RF Gain
VR-3 - Sq. Rng.
VR-4 - S Meter

SBE LCM-8

TX. ADJ.: Peak: T8, L-7, L-11, L-12
RV-4 - RF Mtr. Cal.
RV-2 - AMC (Defeat, pull C-132)
RX. ADJ.: RV-1 - Sq. Rng.
RV-3 - S Mtr. Cal.

SEARS 934.38080700

TX. ADJ.: Peak - T-11, T-12, T-13, T-14, T-15
RT301- RF Mtr. Adj.
Pull: D-7, Q-10
RX. ADJ.: RT-1 - Distorted Mixer Gain
RT-2 - S Mtr. Adj.

TENNA 11302 (AM-FM-CB)

TX. ADJ.: Peak: L-602, L-603, L-604, L-605, L-607, L-609, L-610
Pull: D-703, AMC Defeat
RX. ADJ.: RV501- Sq. Rng.

TRS CHALLENGER 600

CHANGES: Remove driver and final carefully! Put final in driver position, put 2SC1307 in final slot. Pull D-2 or D202 out of circuit (may be marked either way).

NOTE: For frequency modification, see Secret CB, Vol. 7, pg. 23,24
Identical through steps 1, 2, 3.

Step 4: Adjust T-603 and/or T-604 for output on all chan.
Step 5: When finished with above, peak out at mid-range of band.

TX. ADJ.: Max.: T-214, L-208, CV-101
VR210- RF Pwr. Adj. (Don not exceed 10 W dead key!)
VR-1 - AMC
VR-4 - Power Meter (Adj. to the red at dead key)
RX. ADJ.: VR-2 - AGC
VR-5 - Sq. Rng.
VR-3 - RX. S Mtr.

VECTOR 770

TX. ADJ.: Peak: L-17, L-18, L-19, L-20, L-21, L-22, L-25, L-26
FVR3 - AMC (Defeat, C-35)
FVR4 - RF Mtr. Adj.
RX. ADJ.: FVR1 - Sq. Rng.
FVR2 - S Mtr. Adj.

VECTOR 790

TX. ADJ.: Peak: L-17, L-18, L-19, L-20, L-21, L-22, L-25, L-26
FVR4 - RF Mtr. Adj.
FVR3 - AMC (Defeat, pull both Q18 and FVR3)
FVR5 - Voltage reg., set for 12.6 VDC.
RX. ADJ.: FVR1 - Sq. Rng.
FVR2 - S Mtr. Adj.

SPECIFIC RADIO TUNE-UPS (Cont'd):

KRACO KCB-4005

TX. ADJ.: Peak: Fil, T401, T402, L402, L403, L404
VR402- Peak out power
VR201- AMC
VR403- RF Mtr.
Pull: RV-201/MV-1 (This is a varistor)
RX. ADJ.: VR103- Sq. Rng.
VR102- S Mtr. Adj.

MIDLAND 78-574

Channel Modification & Slide Modification is identical to SBE LCBS-4
Secret CB, Vol. 7, Pp. 30-33.

NOTE: In slide modification - 10K resistor goes to pin 9
on connector.

Also, this unit has PLL 02AG in some production runs.
If PLL goes out, the correct substitution is ECG-1233
(Sylvania).

Test radio had final changed to 2SC1307 and driver
to 2SC1306.

TX. ADJ.: Peak: T-3, T-209, L-209, L-212, L-214
RV1, RV2 - Carrier Balance

RV206- Final Bias
RV-3 - SSB Mod. Gain
RV201- SSB RF ALC
RV-9 - AM AMC
RV202- RF Meter Adj. (AM)

RX. ADJ.: VR-1 - AM Power Adj.
RV10 - RF Gain Range
RV-6 - SSB AGC
RV-7 - AM Sq. Rng.
RV-8 - SSB Sq. Rng.
RV-5 - AM S Meter

RV-4 - SSB S Meter (Note: might not be in cal. on USB?)

f_0 range to 28.045

AM Power: 9W+ dead key; modulate to 15W+ (Don't push it!)

SSB Power to about 15W

"Do not Cut out Modulation Limiters!"

SEARS 934.38081700

TX. ADJ.: Peak: T-305, T-306, T-307, T-701, T-702, T-703, T-704
T-705

RT-2 - RF Mtr. Adj.
Pull: D501

RX. ADJ.: RT101- Audio Distortion
Rt-1 - S Mtr. Adj.

SPECIFIC RADIO TUNE-UPS (Cont'd):

TRUETONE CYJ4862A-87

TX. ADJ.: Peak: L-5, T-3, T-4, L-7, L-11, L-12
RV-2 - AMC (Defeat, C-96)
RV-4 - RF Mtr. Adj.
RV601- PA Sensitivity Adj.

REALISTIC TRC-470 AM/FM/CB 21-1591

These units are dogs! Don't know who the manufacturer was, but they are real lemons!

Any way, here goes!

Remove thermistor 301; change to 1K, 1/2 watt
Remove thermistor 501, R-510, R-551, network sleeved in radio, take out - change to 20K, 1/2 watt.

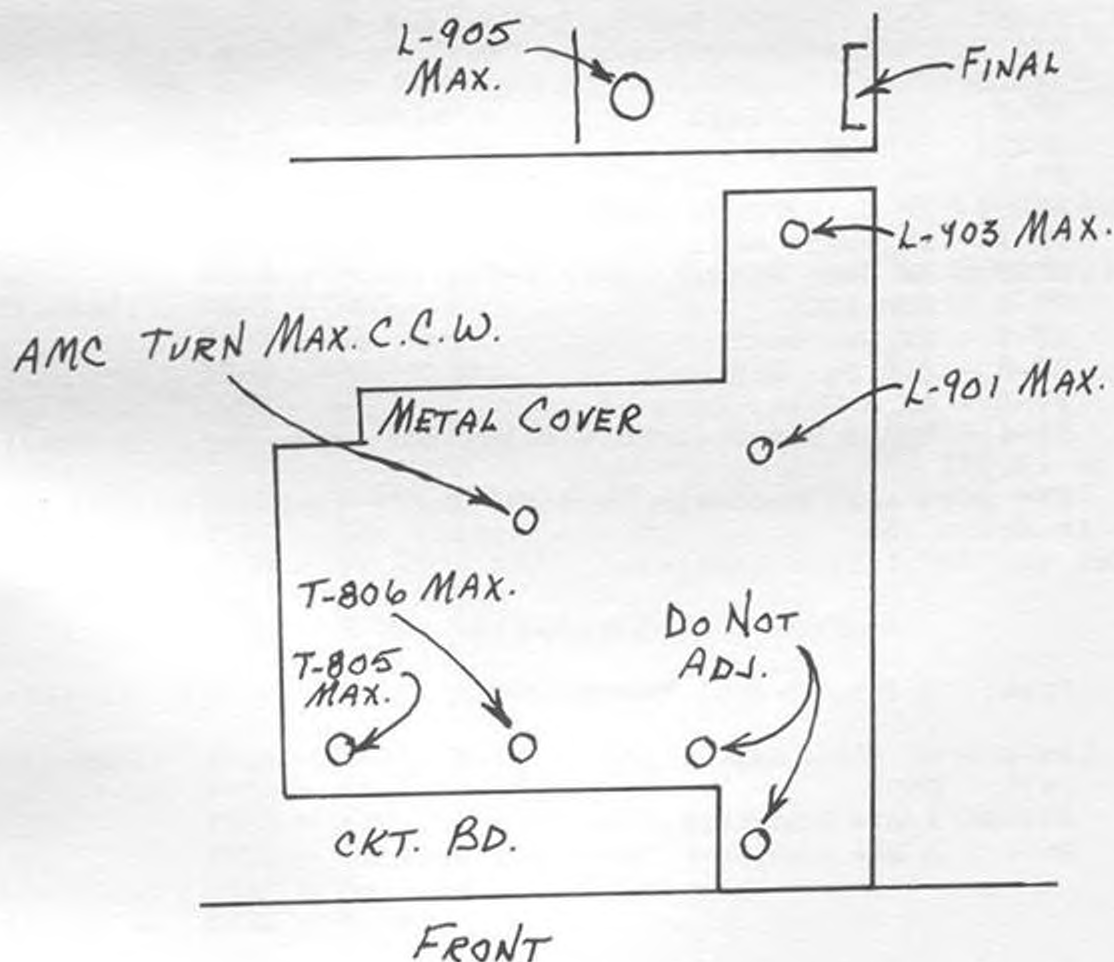

SOLVING TVI

TVI (television interference) resulting from citizens band radio transmitters is an annoying and not uncommon problem. A knowledge of the different causes of television interference and their cures will help the CB operator solve his own individual problem.

The person experiencing the interference is most likely to place the blame on the operator of the transmitter. He may or may not be correct. Unfortunately a number of transmitters on the market are capable of radiating spurious energy along with the desired signal. Even those that are properly designed may cause TVI if one or more of the following conditions are present: weak transmitting tubes; improperly tuned transmitter circuits; misadjusted linear amplifier; poor coaxial cable connections; improper or complete lack of an adequate ground; transceiver out of its case or case screws missing.

Alternatively, it may be that the citizens band station is free of spurious radiation yet a television interference problem exists. This condition may exist because of the lack of ability of many television receivers to properly reject out of band signals.

The first step in solving a television interference problem is to make sure that the offending transmitter is not guilty of any of the previously mentioned causes of television interference.

The next step is to look at the way in which the transmitter can cause interference and how to eliminate it. The class D citizens band radio service is located in a narrow region about 27 MHz. Spurious transmitter energy is most likely to take the form of harmonic radiation. A harmonic is an integer multiple (2x, 3x, etc.) of the fundamental frequency; 27 MHz in this case. As a result, the first harmonic of a citizens band transmitter occurs near 54 MHz and the second harmonic near 81 MHz. Unfortunately these frequencies are occupied by television channels 2 and 5 respectively.

The intensity of the interference at the television receiver will depend upon:

1. The intensity of the harmonic radiation. In general, the higher the harmonic number, the weaker the intensity.
2. Distance between the CB transmitting antenna and the television receiving antenna.
3. The heading of the citizens band antenna if it is directional.
4. The strength of the television channel being received. The strength of the harmonic radiation can be greatly attenuated by placing a filter between the transceiver's antenna terminal and the antenna.

The filter should be of such a design that it passes unattenuated the desired 27 MHz signal yet greatly attenuates any harmonics that may be present at the transmitter output. The most

common form of this filter is called a low pass filter, called so because it passes the fundamental or low frequency signal but impedes harmonics or high frequency energy. A number of these filters are available commercially varying in their power handling capability and the degree of attenuation they offer to harmonic energy. Many of the filters are designed for amateur radio use and as a result are of little or no use in attenuating 1st harmonic citizens band energy which falls on channel 2 television. Avanti makes a low pass filter designed specifically for citizens band use, and as a result exhibits a nominal 80db. (Comparable to reducing the harmonic intensity one hundred million times) at channel 2 and slightly lower on other television channels. (In order to take maximum advantage of a filter it is important that the length of coaxial cable connecting the filter to the transceiver be as short as possible; preferably four inches or less. If convenient, a double male coaxial barrel is the best solution. Any SWR meter, switch boxes, matching networks, etc. should go after the filter. The transceiver should also be connected to a good ground rod buried three or four feet deep. When these steps have been taken, the transmitter should be clean of spurious radiation.

Any remaining interference is most likely a result of front end overloading of the television receiver by the 27 MHz signal. In instances where high power is being used and/or the citizens band antenna is near the television antenna the resulting 27 MHz citizens band signal enters the television receiver and harmonics of the 27 MHz signal are generated within the television itself. In addition, through a process called mixing, other non-harmonically related interference signals may be generated within the television receiver resulting in interference on channels other than channels 2 and 5. Because the harmonics are being generated within the television receiver, the low pass filter on the transmitter cannot stop this radiation. In order to eliminate this interference the intensity of the 27 MHz signal entering the TV receiver must be reduced to such a level that harmonics are not generated and undesirable mixing does not take place. To accomplish this a filter that attenuates 27 MHz energy is attached between the television antenna and receiver. Filters to accomplish this attenuation are commercially available and are of two basic types: the notch filter, and the high pass filter. The notch filter, although quite effective, can be very critical in adjustment and if misadjusted can actually cause the interference to appear worse. High pass filters are more commonly available and can be very effective. The high pass filter will pass, unattenuated, all television channels while attenuating energy below a certain frequency called the cutoff frequency. Whether a notch filter or high pass filter is employed, two points bear mentioning. First, the low pass filter must be left in the trans-

SOLVING TVI (Cont'd):

mitter coaxial line while the notch or high pass filter is being tried on the television receiver as the interference is often a combination of transmitter harmonic generation and television receiver deficiency. Secondly, to be most effective the television filter should be installed as close to the television receiver as is possible. Avanti's high pass filter comes supplied with a four inch length of twin lead and appropriate connectors. In instances of extreme television interference, some interference may still be apparent even after the installation of filters at the transmitter and television receiver. One way in which the residual interference may leak through is by means of the A.C. power lines. To cure this problem a line filter must be installed at the interfering transmitter and/or at the television receiver. Excess cord should be wound around the filter box.

Transistorized TV receivers are many more times susceptible to signal overload (with the resulting internal generation of harmonics) than are their vacuum tube counterparts. Loose, broken, or cracked twin lead will most likely aggravate an interference problem. A television antenna fed with 75 ohm coaxial cable and the appropriate matching transformers is less susceptible to interference than is a system fed with 300 ohm twin lead.

The steps listed above, followed in the proper sequence will result in interference free operation in the majority of instances.



NEW PRODUCT

USED WITH A RADAR DETECTOR, THIS GREAT LITTLE GADGET WILL AUTOMATICALLY DISCONNECT YOUR AUTOMATIC CRUISE CONTROL THE MINUTE A RADAR SIGNAL IS DETECTED.

IMPORTANT FACTS ABOUT ECHO BOXES

There have recently been many questions concerning Echo Boxes, which we hope the following information will answer. Due to the large number of CB manufacturers, it is often necessary to rewire an Echo Box to make it work on a specific radio. It is simple to do, as long as you follow a few basic rules.

1. Echo Boxes are not recommended for use with Linear Amplifiers.
2. To rewire an EB-1 and EB-2 it is important to remember that the connections must be the same at the input and output of the Echo Box. If you change one, the other must be changed to the same configuration.
3. A Midland, Royce, Boman, or Kraco radio requires the audio lead to be open during the receive mode. These units require model EB-6 or EB-7 which has the switching module factory installed.
4. Echo Boxes will work with amplified microphones; however, care is required in setting the input level to the Echo Box so that the Echo Box does not overload or cause a higher signal level input than your radio is designed to take.
5. Astatic, Turner, Telex, provide a microphone wiring booklet denoting the correct wiring of microphones to CB radios. We suggest that you utilize these excellent wiring guides to help in determining the proper pin to pin wiring configuration to convert the Echo Box to a particular radio. You may call the factory for specific wiring information, or with any problem that you feel you need help with.
6. It is important to remember that the Echo Box is used in conjunction with the audio lead and ground; switching wires are straight through with no internal connections.
 - A. Echo Boxes EB-1 and EB-4 (4 pin connector):
This unit is wired to fit Uniden chassis radios which consist of Cobra and President radios, or any other which are wired as follows: Pin #1 - shield; Pin #2 - white; Pin #3 - black; Pin #4 - red. This is commonly known as a relay switching radio. However, some of the electronic chassis are sometimes wired in the same manner.
 - B. Echo Boxes EB-2 and EB-5 (4 pin connector):
These have the audio lead on Pin #1 instead of Pin #2, as is common in the EB-1. If a squeal develops in the receive mode, this indicates a cybernet chassis and will require the model EB-6 or EB-7. EB-2 and EB-5 are commonly known as electronic switching models and will fit a variety of CB radios such as Lafayette, JC Penny, Fannon, Teaberry, etc. To convert an EB-2 to EB-1, exchange

FACTS ABOUT ECHO BOXES - Continued:

Pin #1 to Pin #2 both inside and outside of the Echo Box. This unit is wired as follows: Pin #1 - white; Pin #2 - shield; Pin #3 - black; Pin #4 - red.

- C. Echo Boxes EB-6 and EB-7 (4 pin connector):
These units are wired to fit the cybernet type chassis. It is commonly found in Midland, Royce, Kraco, Boman, etc. This unit opens up the audio lead during receive so that a squeal does not develop in the receive mode. The wiring of the unit is the same as EB-2 and EB-5.
- D. Echo Boxes EB-8 and EB-9 (5 pin threaded lock ring):
These units are designed to fit the Uniden chassis - President, Cobra, etc. This is wired in the following manner: Pin #1 - white; Pin #2 - shield; Pin #3 - black; Pin #4 - red; Pin #5 - blue.
- E. Echo Boxes EB-11 and EB-12 (5 pin din plug connector):
These units are designed to fit the G.E. - 5800 series and similar 180 degree din plug type radios. A six conductor mike cord is provided so this unit can be wired to fit Realistic, Lafayette, or other types chassis which require 5 pin connectors and mike cords. These units are wired in the following manner: Pin #1 - shield; Pin #2 - No connection; Pin #3 - red; Pin #4 - white; Pin #5 - black.

All units are available with a Modulation Linear Booster. This is a standard Echo Box - however, when the toggle switch is on (in the up position), the echo reverberation is displaced and full amplification of the audio signal (up to 22 db additional gain) is fed into your radio to allow full modulation and results in a much louder on-the-air signal: The slide control from 0-10 controls the amount of gain to allow full control of input levels to prevent overloading the input level of your radio.

OOPS! WE GOOFED!

Volume 4, Page 51 for Royce 1-641 - should be cut R99, not R98. Move pink wire from board and connect to Fuse 3 on power supply board. To increase slide, remove power supply chassis, open cover on PLL Osc. unit. Clarifier varactor is located at lower rear of PLL board. Pull trimmer cap next to varactor - lift anode of varactor and install super slide between anode and where anode was connected.

VOICE SIGNAL BOOSTER

(VSB-1 INSTALLATION)

You have just purchased one of the most unique and effective methods of speech processing for communications gear available on the market today. It incorporates amplitude expansion on the receiver portion of your radio, and amplitude compression of the transmitted voice signal, while at the same time giving you improved signal-to-noise ratio. The waveform is essentially unmodified and, thus, undistorted. Because of the low distortion, the compressor can be left in the circuit at all times, unless you wish to demonstrate to someone else the effectiveness of the circuit. The compressor will give you more talk power than most power mikes or other speech processors on the market today.

With the expander, you will have up to 16 dB improvement in the signal-to-noise ratio of the received signal, no matter what type of rig is transmitting. You will also be able to pull distant stations in that no one else in your area is able to hear, because you don't have to contend with the noise that everyone else is receiving along with the transmitted signal. However, the expander won't help if the audio peaks are no higher than the noise. If this is the case, the noise and audio will be expanded equally. If the signal is lower than the noise level, it can make reception worse with the expander switched in, but so far we haven't found this to be the case. Most of the time the expander makes an improvement varying from the noticeable to the spectacular. A signal strong enough to actuate the avc will produce a S/N ratio in excess of 30 dB with the expander in circuit.

Although you have probably purchased this unit for CB gear, it will work in any communications equipment, whether it is AM, SSB, FM, UHF or VHF. It is only illegal, in that if it is installed internally in the radio, it will void the FCC type acceptance.

INSTALLATION

I. CONNECTING THE EXPANDOR CABLE:

- A. Locate the first audio amplifier which is connected to the output of the AM detector diode. Refer to Fig. 1.
 1. Remove the coupling capacitor which is connected to the output of this amplifier.
 2. Insert the black lead from the expander coax cable into the hole on the side which is connected to the collector of the amplifier.
 3. Insert the white lead from the expander coax cable into the other hole.
 4. Connect the shield wire of expander coax to the nearest common ground (usually a transformer shield).

VOICE SIGNAL BOOSTER INSTALLATION (Cont'd):

B. Connecting the expander cable when there is no coupling capacitor between the first audio amplifier and the volume control:

1. If there is not a coupling capacitor as indicated in Figure 1, remove the shielded cable which connects from the first audio amplifier to the volume control as indicated in Figure 1.
2. Insert the black lead of the expander coax into the hole left open by the removal of the shielded cable conductor.
3. Connect the white lead of the expander coax to the cable which was removed from the radio.
4. Connect the shield wire from expander coax to the nearest common ground.

II. CONNECTING THE COMPRESSOR CABLE: (Blue coded leads)

- A. Remove the coupling capacitor which is located between the microphone preamplifier stage and the following audio amplifier stage.
- B. Insert the black lead of compressor cable into one of the holes which was left open by the removal of the coupling capacitor. The black lead must connect to the output of the preamplifier stage which is usually the collector of the transistor.
- C. Connect the white lead of the compressor cable in the other hole.
- D. Connect the coax shield wire to the nearest transformer shield.

III. CONNECTING THE POWER SUPPLY LEADS TO 12 VOLT DC SOURCE:

- A. Connect the red lead of the module to +12 volts DC.
 1. If you are installing this unit in a mobile radio, connect the red lead to the on-off switch on the radio.
 2. If you are installing this unit in a base station, connect the red lead to the closest +12 volt DC source.

B. Connect black lead of VSB-1 to common ground of radio.

CAUTION: Common ground is not to be confused with chassis ground. Common ground can be found by locating any transformer shield, since these shields are usually connected to common ground.

NOTE: If you have any questions about the installation or operation of the module, call your supplier, or refer to volume 9 of Secret CB for more data.

VSB-1 (SHOWN ACTUAL SIZE).

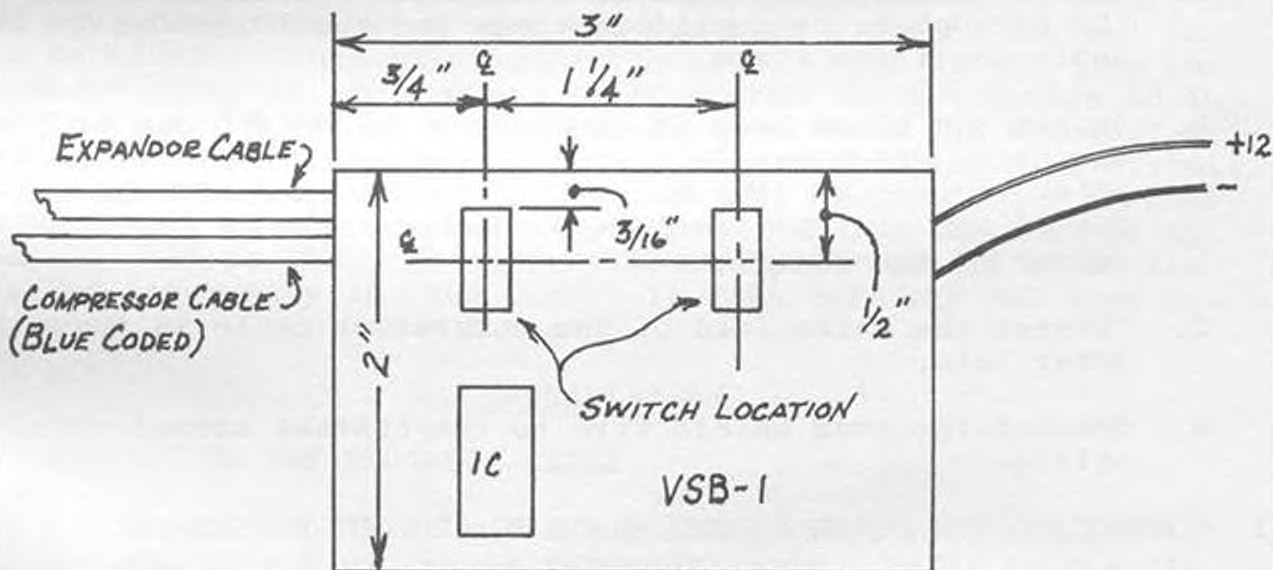

DRILL TWO (2) 1/4" DIA. HOLES 1 1/4" APART FOR SWITCHES IN A CONVENIENT PLACE TO MOUNT VSB-1. MAKE SURE THERE IS ENOUGH CLEARANCE SO BOARD WON'T TOUCH ANYTHING ELSE IN RADIO.

BLOCK DIAGRAM OF TYPICAL INSTALLATION

FIGURE 1

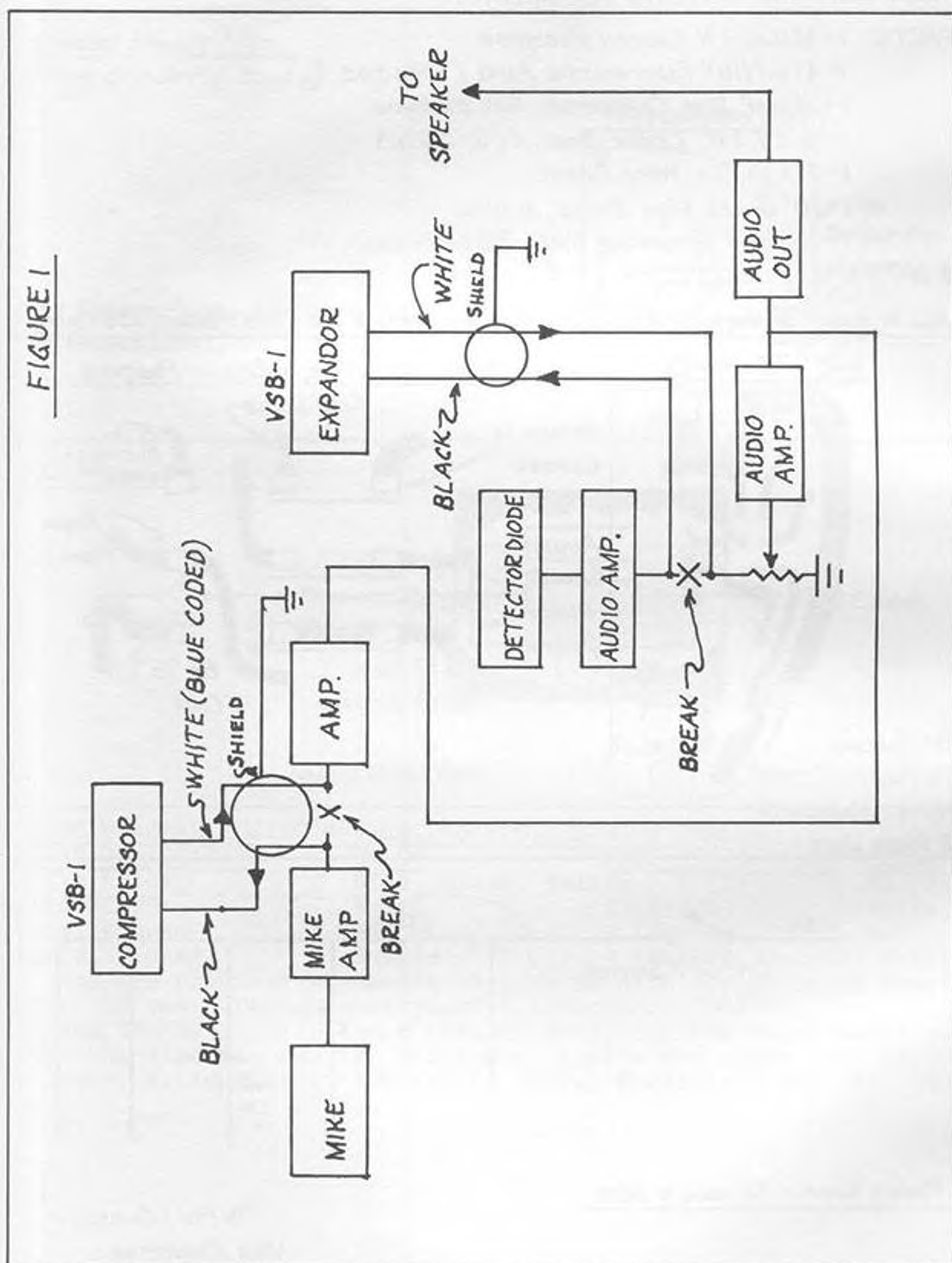

POWER SUPPLY MODIFICATION

FOR REALISTIC PRE-AMP NOISE-CANCELLING MIKE #21-1175

THROW AWAY THE BATTERY, PERMANENTLY!

- PARTS:** 1- 220 Ω 2W. CARBON RESISTOR
 1- 47 μ F/16V ELECTROLYTIC AXIAL CAPACITOR
 1- .01 μ F DISC CAPACITOR, 50V MINIMUM
 1- 6.8V, 1W. ZENER DIODE, ECG-5071A
 1- 1" X 5/8" DIA. WOOD DOWEL
 * 1- 10' COILED MIKE CABLE, 6 WIRE
 1- 1' PIECE STRANDED WIRE, 22 GA.

* OPTIONAL

ALL WIRING CONNECTIONS ON INTERCONNECTION PERTAIN TO PRES. ADAMS (858 CHIP).

MIC P.C. BOARD

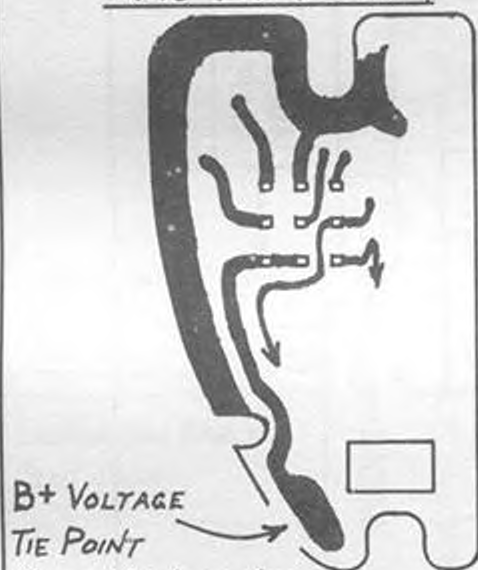

NOTE: MINIMUM OF 2 WIRES USED!

SWITCH SCHEMATIC, IN RECEIVE POSITION

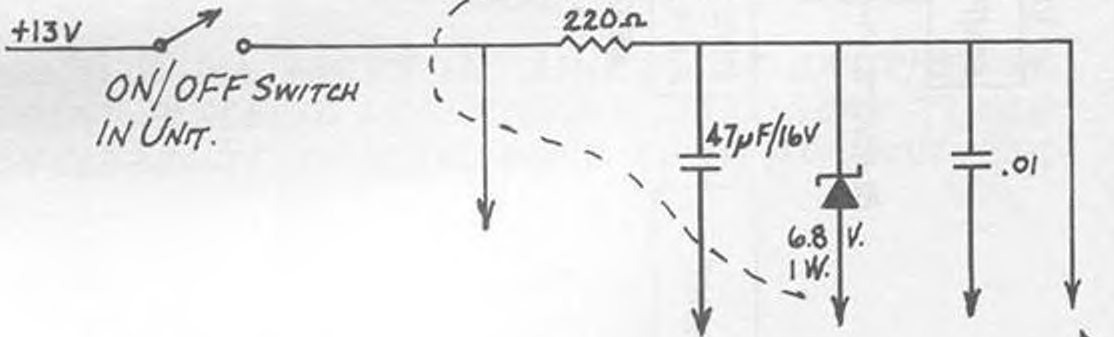
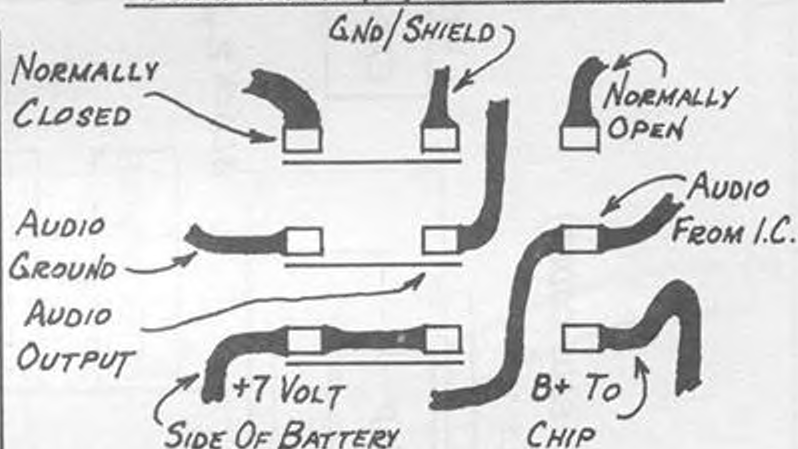

POWER SUPPLY SCHEMATIC MOD.

TO PIN 1 CHASSIS
MIKE CONNECTOR

CHASSIS MOUNT MOD.
(BACK SIDE OF P.C. BOARD)

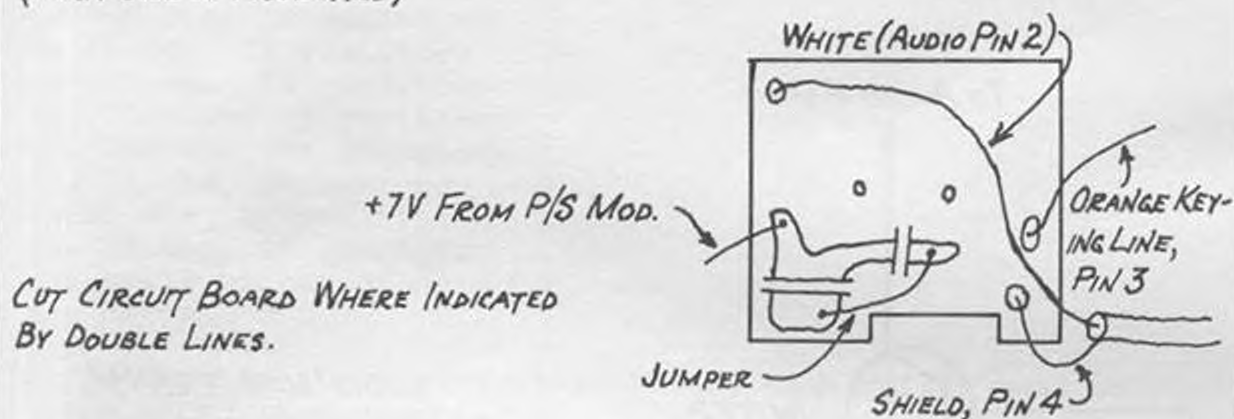

P/S MOD. CONSTRUCTION

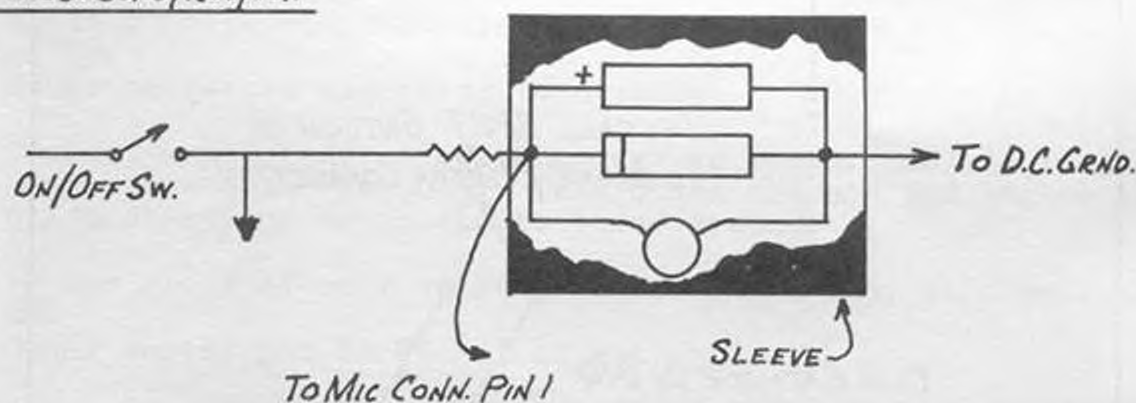

WIRING DIAGRAM, USING 6-WIRE, 10' COILED MIKE CABLE:

WIRING DESIGNATION	COLOR	PLUG DESIGNATION	COLOR
B+ Tie Point	Blue, Black, Yellow	1 (B+)	Blu, Bl, Y
Audio Output	White	2 (Audio)	White
Normally Open	Red	3 (Keying)	Red
Shield, Ground	Shield	4 (Shield, Ground)	Shield

You are probably wondering what to do with the piece of dowel. Put it in the battery compartment, of course!

Our thanks to Bill Wentz (Trader Bill) for the above modification. He also has the 10' lengths of 6-wire mic cable, for \$6.50. To order, write Bill at 106 Fannin Drive, Goodlettsville, Tn. 37072.

HINTS & KINKS

SWITCHABLE MODULATION INCREASE

Correction
Vol 10
Page 72,74,75

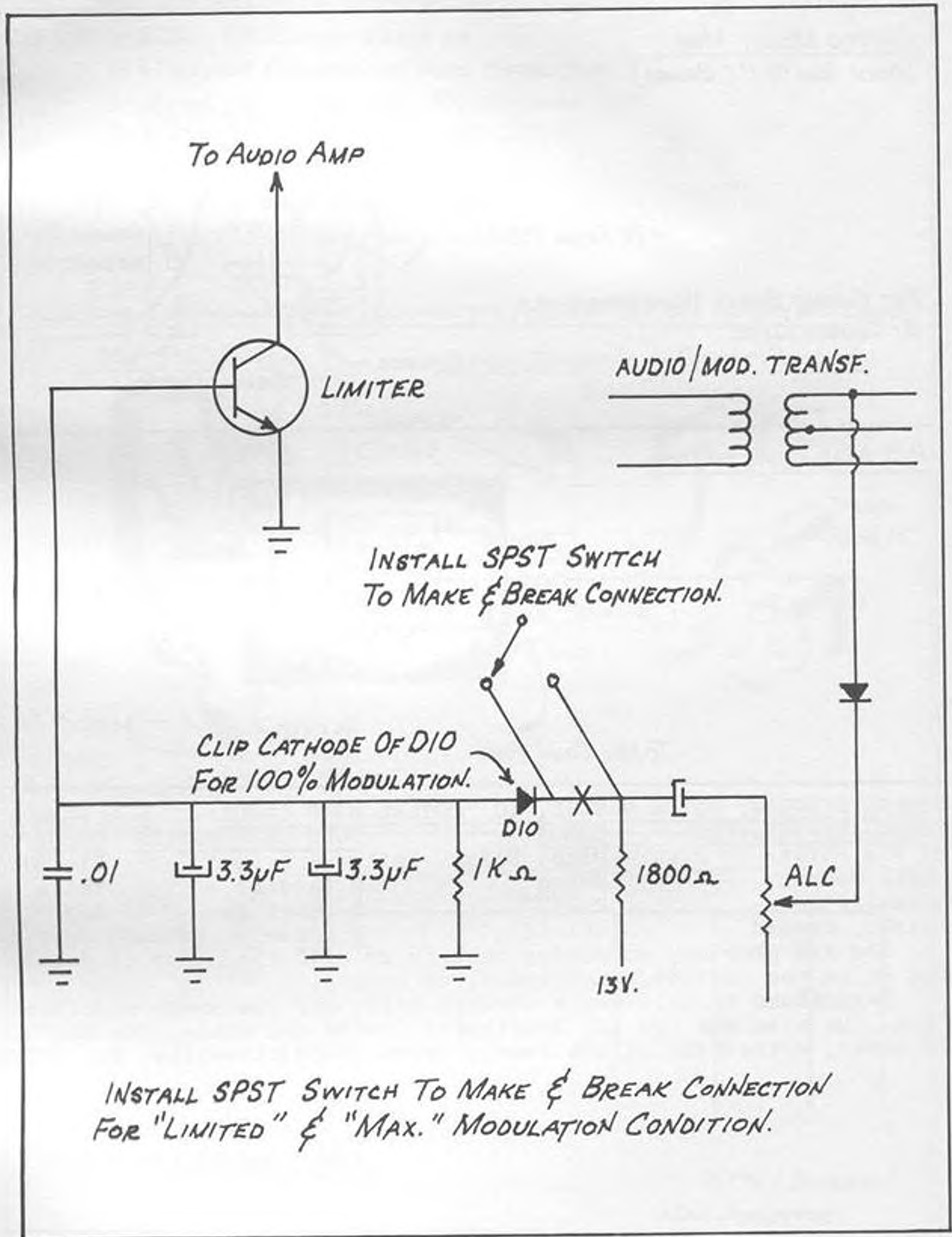

RF ATTENUATOR

PARTS NEEDED:

- 2 ea. SO239
- 7 ea DPDT Center Off Switches
- 1 ea Wood grain cabinet (looks nice)
- 4 ea 240 ohm, 2W resistors
- 8 ea 62 ohm, 2W resistors
- 2 ea 100 ohm, 2W resistors
- 2 ea. 150 ohm, 2W resistors
- 2 ea. 300 ohm, 2W resistors
- 1 ea. 68 ohm, 2W resistor
- 1 ea 39 ohm, 2W resistor
- 1 ea. 18 ohm, 2W resistor
- 2 ea. small pieces of coax
- 8 ea. Screws

1. If unit is to be used above 30MHz, each switch must be shielded. (See drawing)
2. Drill 7 holes in front and mount switches
3. Drill 2 holes for SO239 in back
4. Mount resistors according to drawing
5. Connect small coax to SO239 center to center, shield to frame. (Mark this SO239 as out). Take other end and put center to pin 2 of switch A, shield to strap ground.

Second piece of coax to other SO239 (mark IN); wire as above

Other center put on Pin 41 of switch G

6. A ground strap shorts all of the single resistors on pins 3, 4, 9, 10, 15, 16, 21, 22, 27, 28, 33, 34, 39, 40 to each other.

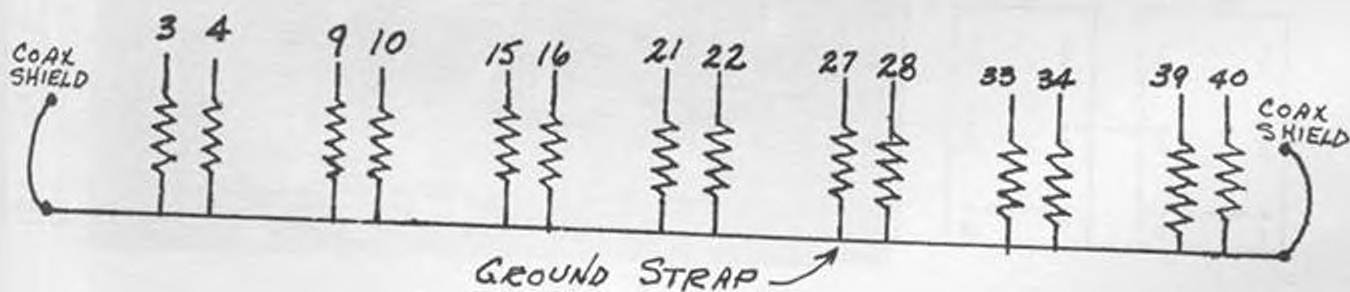

RF ATTENUATOR (Cont'd)

7. To use above 30MHz you must enclose each switch in its own shield box. We recommend copper-coated circuit board. Good to approximately 500MHz. Be careful, for jumpers between switches must be isolated from the box; so must all other parts of each switch. (To isolate jumper wires, use transistor insulators).
8. (A). This completes unit - with switches up, unit acts as a piece of straight wire.
 (B) With switches down all the way, the unit acts as 3, 6, 10, 20, 20, 20, 20 db attenuator.
 (C) With switches in the middle, it cuts the above by half: 1½, 3, 5, 10, 10, 10, 10 db.
9. This gives you a versatile attenuator that allows you to check the gain of any receiver, preamp, antenna, or signal source.
 Start out with all switches off. Start switching until no sound is heard, or signal meter shows \emptyset .
10. One suggestion: we put in 2 watt resistors because we use this in checking CB radio receivers, and by chance one or more switches were down during TX. It would not hurt unit if TX was for a short time (do not exceed 5watts through loaded switch). Damage may result. TX is fine with all switches off. There is no known SWR increase.
11. Can help cut bleed-over.

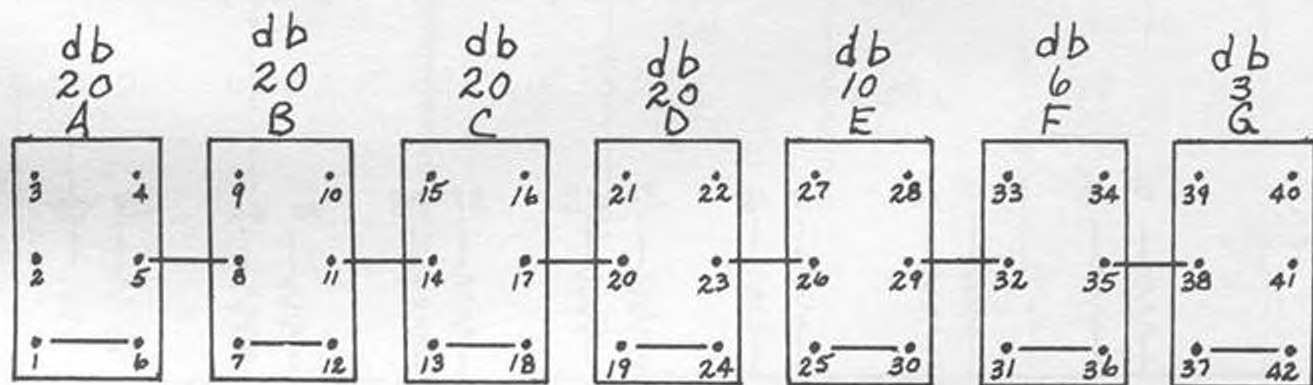

RF ATTENUATOR (Cont'd)

Short with strap wire, switch pins 1 & 6, 7 & 12, 13 & 18, 19 & 24, 25 & 30, 31 & 36, 37 & 42.

Short with wire, switch pins 5 & 8, 11 & 14, 17 & 20, 23 & 26, 29 & 32, 35 & 38.

Switch A - 240 ohm, 2W resistor across pins 2 & 5
Switch B - 240 ohm, 2W resistor across pins 8 & 11
Switch C - 240 ohm, 2W resistor across pins 14 & 17
Switch D - 240 ohm, 2W resistor across pins 20 & 23
Switch E - 68 ohm, 2W resistor across pins 26 & 29
Switch F - 39 ohm, 2W resistor across pins 32 & 35
Switch G - 18 ohm, 2W resistor across pins 38 & 41

Install a resistor on each of the following switch pins:

Switch A - 62 ohm at pins 3 & 4
Switch B - 62 ohm at pins 9 & 10
Switch C - 62 ohm at pins 15 & 16
Switch D - 62 ohm at pins 21 & 22
Switch E - 100 ohm at pins 27 & 28
Switch F - 150 ohm at pins 33 & 34
Switch G - 300 ohm at pins 39 & 40

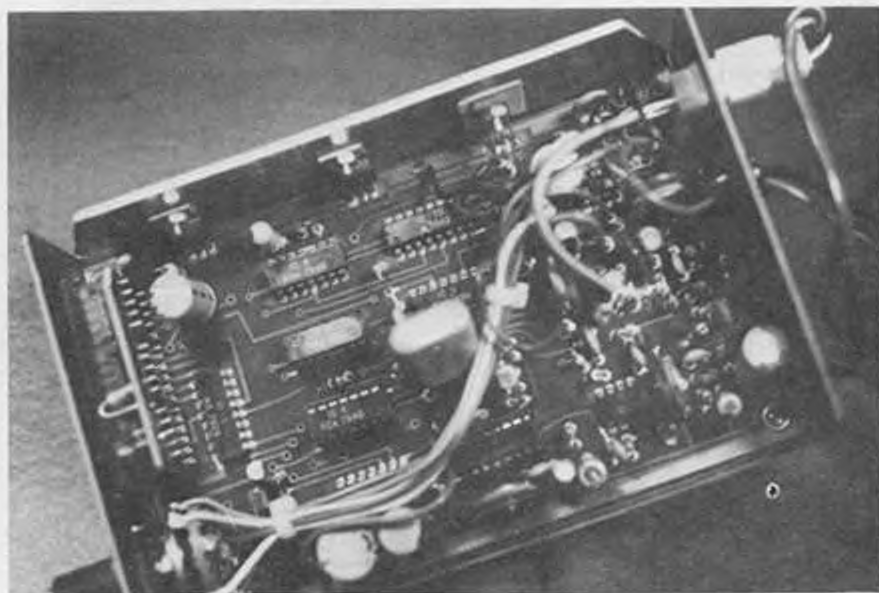

INSIDE THE SPEEDO-1

SERVICE BULLETIN

MODE: ALL PRESIDENT CITIZENS BAND MOBILE TRANSCEIVERS

SUBJECT: PERFORMANCE REQUIREMENTS FOR AC POWER SUPPLIES

It is most desirable to use a regulated supply set to 13.8 VDC output with 1% or better regulation and load current capability of at least 3 amperes continuous. Such a supply may be used with any President mobile unit. A supply with a capability of at least 2.5 amperes will be satisfactory for any President AM mobile unit.

In view of the fact that many non-regulated or poorly regulated supplies are available and frequently used, minimum standards must be considered in determining the suitability of a particular power supply unit. The following minimum standards should be followed if satisfactory performance is to be obtained. These apply to both AM and SSB transceivers:

1. Open circuit (no load) DC supply voltage must not exceed 15.0 volts.
2. With the receiver turned on with no signal and squelch closed the DC supply voltage must not exceed 14.8 volts.
3. With the receiver turned on with a strong signal, the squelch open and the volume control fully advanced the DC supply voltage must be between 13.1 volts and 14.5 volts.
4. With the transmitter keyed (AM mode if SSB/AM unit) but without modulation the DC supply voltage must be between 14.1 volts and 12.5 volts.
5. With the transmitter keyed and with a continuous tone modulation the DC supply voltage must be between 14.0 volts and 12.5 volts.

Please note that all five criteria must be satisfied to have an acceptable supply. It should also be noted these standards apply only to accessory AC supplies and must not be construed to be universal limits that might also apply to batteries or other types of supplies.

SERVICE BULLETIN

MODEL: GRANT, WASHINGTON, ADAMS, & MADISON using UHIC-005A
VCO Integrated Circuit.

COMPLAINT: Transmitted signal cannot be clarified. Transmitted signal has "warble". Sounds like transmitting with microphone under water.

CORRECTIVE ACTION:

Install a 330 ohm 1/8 or 1/4 watt carbon resistor in series with the center conductor of the coaxial cable providing local oscillator injection to the first receiver mixer, FET-1. The resistor is to be installed with one end mounted in the printed circuit board hole provided for the center conductor of the coaxial cable at the "FET-1 end" of the cable. Lead lengths on the resistor must not exceed 1/4 inch overall length.

NOTE TO TECHNICIANS:

Use of the UHIC-005 was discontinued recently and the UHIC-005A used in its place. Measurements made at the factory indicate only a very small percentage of the units shipped have the indicated problem and it is confined to radios using the UHIC-005A.

Technicians should make the indicated change when the complaint is as indicated above or on any unit requiring service for other reasons although this specific complaint is not registered.

MODEL: TEDDY R

COMPLAINT: NOISE BLANKER CAUSES DISTORTION OF INCOMING SIGNALS.
UNIT OPERATES BETTER WITH NOISE BLANKER OFF.

CORRECTIVE ACTION:

This problem is normally related to an installation which has a higher than normal amount of ignition impulse noise. The problem may be identified by observing that when a signal strength indication of S-7 (25mV) or higher is present and the noise blanker is on, intelligibility of the incoming signal is poorer than when the noise blanker is turned off.

Installations with usual amounts of ignition noise will not have the problem. Modifications are to be performed only when a specific complaint is received and the symptoms verified.

The parts required are:

2 each 1S2473 Silicon Diode	P/N 2000-303 (1N914)
1 each 0.47uf, 16V Capacitor	P/N 1800-301
1 each 56K ohm, 1/8 W resistor	P/N 1900-067

Install these parts as indicated on the following schematic.

INSTALL CIRCUIT SHOWN BELOW IN HEAVY LINES ON FOIL SIDE. SLEEVE PARTS TO AVOID SHORTING CIRCUIT TRACES.

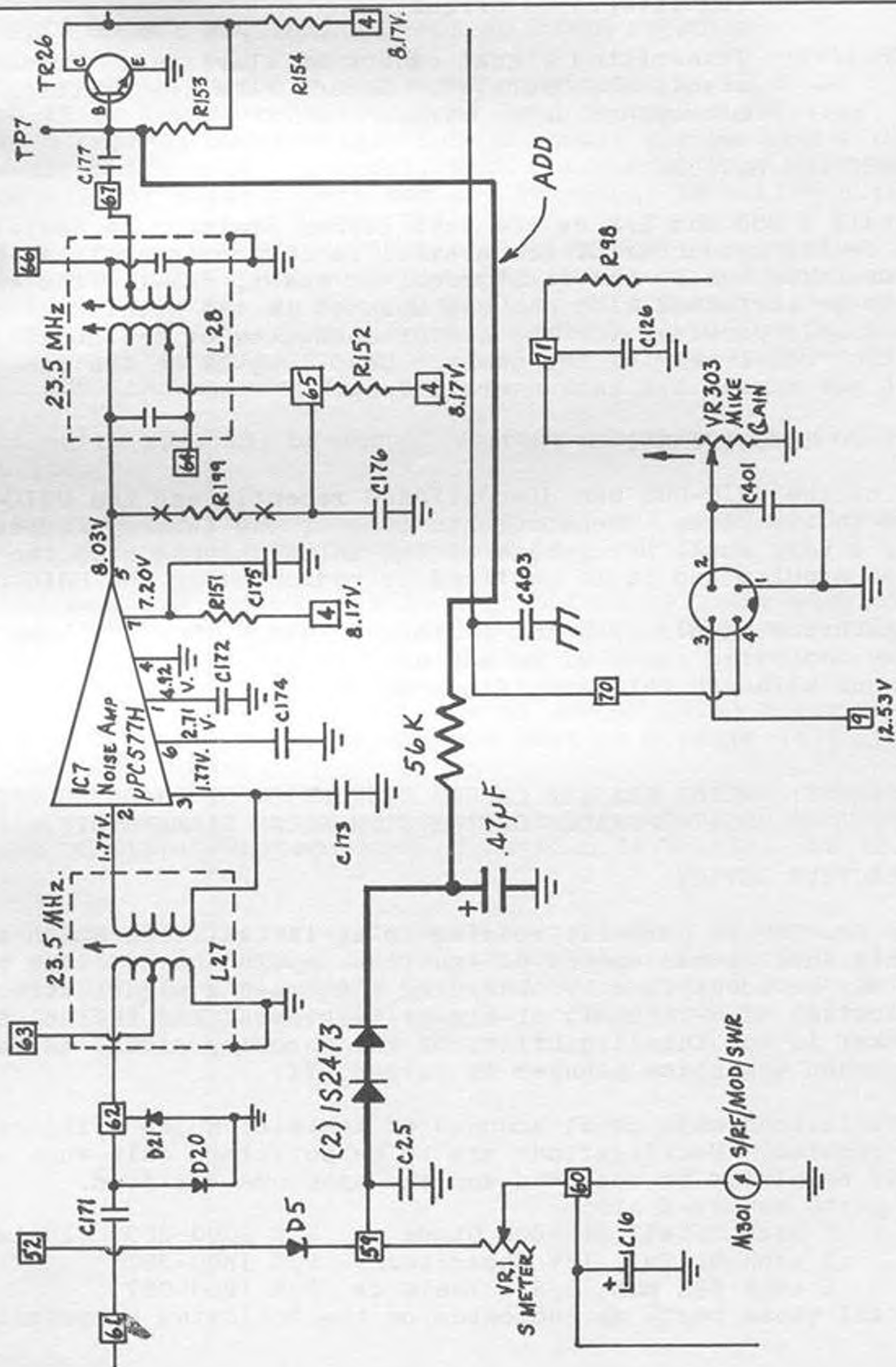

SERVICE BULLETIN

MODEL: DWIGHT D AND ZACHARY T
COMPLAINT: FAILURE OF D201, D202, D203, D204 (1N4001 or SR1K-1)
CORRECTIVE ACTION:

Occasional reports are received indicating failure of D201, D202, D203 and D204 in the Dwight D and Zachary T. You will find this results from one or a combination of the following causes:

1. Inadequate allowance for air flow around transceiver so that overheating occurs.
2. Mike gain operated at too high a setting resulting in high duty cycle requiring excess current from power supply during transmitting.
3. Extensive periods of transmitting so that intermittent design rating of power supply is exceeded.

When it is found necessary to replace these diodes, the replacement parts should be mounted using the full lead length supplied (1 to 1½ inches) on the replacement parts. High temperature sleeving must be placed over the leads of each diode to prevent shorting. Mounting the diodes "in the air" with full leads will substantially increase the heat dissipation capability of the parts and prevent future failure.

NUMBER: VO18-12-78
MODEL: Veep
COMPLAINT: Failure of TR-15 (p/n 2000-208)

CORRECTIVE ACTION:

When it is necessary to replace the final RF power amplifier transistor, TR-15 (p/n 2000-208) the white ceramic insulator (p/n 3400-401) should be replaced with a mica insulator (p/n 3400-211). Make certain an ample quantity of thermal compound or silicon grease is used on the new parts.

This change should be made only on units in which TR-15 has failed.

SERVICE BULLETIN

NUMBER: MKG--017-9-78

MODEL: GRANT (1005002)
MCKINLEY (1011001)

COMPLAINT: Failure of the voltage regulator IC MB3756

CORRECTIVE ACTION:

1. Replace the protector diode SR1K-2 (Grant--D44, McKinley--D60) with zener diode part number 2000-326 (WZ162).
2. Install the diode, removed in step 1, (SR1K-2) between Pin 1 and Pin 2 of MB3756. (Cathode to Pin 2, anode to Pin 1.)

MODEL: JOHN Q., HONEST ABE AND TEDDY R

COMPLAINT: Channel readout is not bright enough in high ambient light.

NOTE: The content of this service bulletin is for information only. The changes indicated herein may be made by authorized warranty service stations without voiding the original warranty.

CORRECTIVE ACTION:

Occasionally a consumer will complain that the channel readout is not bright enough. This will usually result from the transceiver being mounted where it is subject to direct sunlight or with an oblique viewing angle. The following modifications may be installed, but will give only moderate improvement.

1. Replace TR-15 on the John Q or TR-25 on the Honest Abe and Teddy R. (2SD467) with a 2SC1419 (P/N 2000-212)
2. Replace R-78 on the John Q. or R-140 on the Honest Abe and Teddy R. with a 27 ohm 2 watt (minimum) resistor. R-78/R-140 was 120 ohms.
3. Disconnect the outside terminal of VR-4 on the John Q or VR306 on the Honest Abe and Teddy R (dimmer control) from the main printed circuit board and reconnect to the switched side of the DC input on/off switch located on the rear of the volume control.

SERVICE BULLETIN

MODEL: WASHINGTON AND GRANT

COMPLAINT: Failure of TR-5 (P/N 2000-214) resulting in poor or inoperative receiver.

NOTE: Previous modifications are satisfactory and need not be updated.

CORRECTIVE ACTION:

1. Replace TR-5
2. Install a 10K ohm 1/4 or 1/2 watt resistor directly across the antenna connector (J401). Make certain good solder joints are made. Difficulty in heating the ground side may be encountered. Use minimum lead length.
3. Install a pair of back to back diodes directly across the primary of L3. Use P/N 2000-310 (1S2373) or equivalent. It is essential that minimum lead length be used on the diodes.
4. It will be necessary to realign L3 and L4 to obtain optimum performance. This should be done on channel 19 or 20.
5. Schematic

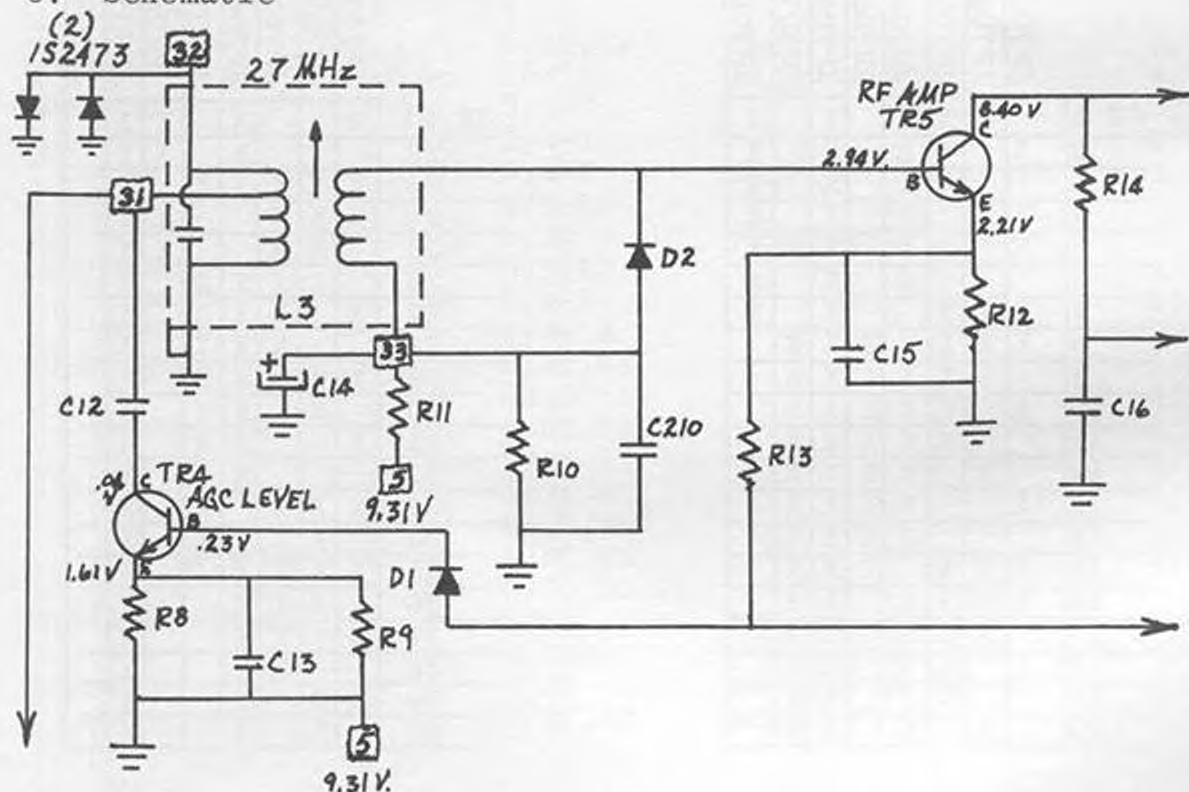

6. Make certain the shielded lead connected to the antenna connector is dressed as far away as possible from TR-5.

SERVICE BULLETIN

MODEL: ADAMS

SUBJECT: INSTALLATION OF CHANNELS OTHER THAN 19 FOR SCANNING/
PRIORITY FUNCTION

The ADAMS has provisions for changing from the factory wired choice of channel 19 to any other CB channel, for the scanning and priority functions. When this change is made, the new channel will replace channel 19 in the scan/priority function.

Channel changes described herein may be made only by properly licensed technician.

The jumpers JP701 through JP708 are to be installed as indicated on the following truth table. The "X" indicates the jumper is to be installed.

The jumpers are located on the printed circuit board immediately to the rear of the channel selector switch and are marked on the top side of the board.

	JP701	JP702	JP703	JP704	JP705	JP706	JP707	JP708
CH 1		X	X	X		X		X
2	X		X	X		X		X
3			X	X		X		X
4		X		X		X		X
5	X			X		X		X
6				X		X		X
7	X	X	X			X		X
8	X	X	X	X	X	X	X	
9		X	X	X	X	X	X	
10	X		X	X	X	X	X	
11			X	X	X	X	X	
12		X		X	X	X	X	
13	X			X	X	X	X	
14				X	X	X	X	
15	X	X	X		X	X	X	
16	X	X	X	X		X	X	
17		X	X	X		X	X	
18	X		X	X		X	X	
19			X	X		X	X	
20		X		X		X	X	

	JP701	JP702	JP703	JP704	JP705	JP706	JP707	JP708
CH 21	X			X		X	X	
22				X		X	X	
23	X	X	X	X	X		X	
24	X	X	X			X	X	
25		X	X			X	X	
26		X	X	X	X		X	
27	X		X	X	X		X	
28			X	X	X		X	
29	X	X		X	X		X	
30		X		X	X		X	
31	X			X	X		X	
32				X	X		X	
33	X	X	X		X		X	
34		X	X		X		X	
35	X	X	X	X			X	
36		X	X	X			X	
37	X		X	X			X	
38			X	X			X	
39	X	X		X			X	
40		X		X			X	

SECRET CB INDEX
VOLUMES 1 THRU 8

10 METER CONVERSIONS:

<u>RADIO</u>	<u>VOL/PG</u>	<u>RADIO</u>	<u>VOL/PG</u>
BOMAN CB930	3/21	DAK IX	5/21-23
CB950	5/39	X	4/39-46,
CBH990	5/43	DEMCO STAR II	5/60
BROWNING LTD	1/53	SUPER SATELLITE	5/60
MKIII	6/28		
MKIV	6/29, 30		
MKIV, IVA	7/8-13	GEMTRONIX GTX 77	5/39
		HALLICRAFTERS HCM271	5/50, 51
COBRA 29GTL	8/16	6/39	
32XLR	4/47	HYGAIN I-A	1/22
87GTL	8/16	PLL	1/32
89GTL	8/16	II	8/20
132B	1/53		
135B	1/53	JC PENNY 6248	8/24
135XLR	4/38		
138XLR	1/20, 23	MIDLAND 79-893	2/20
139XLR	1/20, 23	79-900	5/47
140GTL	3/19, 20	MORSE 3005	2/27
148GTL	8/15		
1000GTL	8/16	NESCO 1249	6/38
2000 (C.A.P.)	6/23		
2000GTL	5/20, 7/	PACE 8092	6/35, 36
	15-17	PALOMAR 500	4/19, 20,
COLT SX33	3/4-7	5/32-36,	
290	3/4-7	8/21	
390	3/4-7	PEARCE CHEETAH PLL	1/31, 32
480	3/8-15	SIMBA PLL	1/31, 32
	5/39	PRESIDENT ADAMS	2/16
485	3/8-15	GRANT	1/22, 23,
800	3/4-7	GRANT(NEW)	5/24-27
1000	3/8-15	HONEST ABE	1/60
COURIER CENTURION PLL	1/31, 61,	JOHN Q	1/60
GALAXY	62, 5/55	MCKINLEY	4/12, 13
GLADIATOR PLL	5/53, 54	TEDDY R.	1/60
SPARTAN	7/18-22	WASHINGTON	1/22, 23, 59
	1/31, 61,	ZACHARY T	1/60
	62, 5/55		
	1/61, 62,		
	5/30, 53, 55		
CPI 300	8/21	RCA 14T302	5/11, 39
400	8/21	14T302 (PLL 02AG)	4/36
2000	3/25	REALISTIC TRC-431	7/23, 24
2500	5/37, 38	ROBYN WV-23	1/24, 25

10 METER CONVERSIONS (CONT'D):

<u>RADIO</u>	<u>VOL/PG</u>	<u>RADIO</u>	<u>VOL/PG</u>
ROBYN GT-440D	1/23	TEABERRY	1/43, 5/30
SB-505	5/41, 42	MODEL T	4/3, 4
SB-520D	2/21, 22	RACER T	1/58
SB-540D	5/19, 36, 7/25-38	RANGER T	4/1, 2, 6/24, 25
ROYCE 1-601	1/26	STALKER I (4001/4002)	4/7-9
612	5/45	T BEAR	4/14, 15
SBE FORMULA D	1/49	T DISPATCH	4/14, 15
TOUCH COM	1/50, 51	TITAN T	4/14, 15
39CB SIDEBANDER V	2/36, 37	TRAM D42	4/47, 5/40
SIDEBANDER II	2/28-35	D60	1/53
CONSOLE IV	2/28-35	D201	1/56, 3/22, 23
SIDEBANDER, CONSOLEVI	8/14	D300	8/11-13
CONSOLE V	2/38-37	TRS CHALLENGER 460	4/28
LCBS-4	7/29-33	600	4/28
LCMS-4	7/34-37	730	4/30
SEARS 934-38260700	6/26, 27	1200	4/31
934-38270700	5/28, 29	850/1400	4/21-27, 32-35
SILTRONIX 1011C	1/46	VICTOR 770	4/56, 57
1011D	1/46	790	4/58, 59
SONAR FS-2340	5/31	YAESU 100	5/58
STANDARD HORIZON 29A	5/58	FT-901	6/3-12
STONER PRO-40	4/52, 53	FT-7B	7/38-41
SUPERSCOPE AIRCOMMAND			
CB340	8/19		
SWAN SIGNET 270	5/58		

SLIDE MODIFICATIONS:

<u>RADIO</u>	<u>VOL/PG</u>	<u>RADIO</u>	<u>VOL/PG</u>
BOMAN 950	4/49	CPI 2500	5/37
COBRA 132-A	1/28	DAK X	4/45
135-A	1/28	GEMTRONICS GTX-77	4/49
135-B	1/29	HYGAIN 623	1/33
138	1/28	674-A	4/60
139	1/30	JOHNSON 352	1/34
140GTL	4/50	MIDLAND 13-893	4/51
142GTL	4/50, 8/35-37	13-898	1/36
135XLR	8/38	13-898B	1/35
COLT 485	4/49	79-960	5/47
COURIER CENTURION	1/61		
GALAXY	5/53		
GLADIATOR PLL	1/61		
SPARTAN	1/61		

SLIDE MODIFICATIONS (Cont'd):

<u>RADIO</u>	<u>VOL/PG</u>	<u>RADIO</u>	<u>VOL/PG</u>
PACE 1000	1/37,38	ROBYN SB-540D	5/19
DX1023B	1/39	ROYCE 1-632	5/14
8092	6/37	1-641	4/51
PALOMAR 500	4/19,5/ 32,35	SBE SIDEBANDER II	2/28-35
PEARCE BENGAL	1/40	SIDE BANDER V	1/47
CHEETAH	1/40	CONSOLE IV	2/38-40
SIMBA	1/40	CONSOLE V	2/28-35, 38-40
PRESIDENT ADAMS	2/16	SEARS 934-38270700	5/28
GRANT	1/59	934-38310700	5/19
GRANT (NEW)	8/34	SILTRONIX SSB	1/45
MCKINLEY	4/12	STONER PRO-40	4/52,53
WASHINGTON	1/59	TEABERRY STALKER IX/XV4/7,8	
WASHINGTON(NEW)	8/33,34	TRAM D60	1/52
RCA 14T302	4/49	D201	1/56
REALISTIC TRC-47	1/41		
TRC-48	1/42		
TRC-458	8/39,40		
ROBYN SB-505	5/41		

SPECIFIC RADIO TUNEUPS:

<u>RADIO</u>	<u>VOL/PG</u>	<u>RADIO</u>	<u>VOL/PG</u>
AIR COMMAND CB-640	5/38	CLARION DMA066	3/45
ALARON B-5200	3/41	JC202E	3/45
AUDIOVOX MCB750	3/41	RCJ003	3/45
MDV6000	6/18	TC203E	6/18
AUTOMATIC CBH2265	3/41	COBRA 19	7/51
BOMAN CB555	3/44	21GTL	3/41,58
CB750	2/43	21XLR	1/20
CBH900	3/44	25GTL	3/41,58
CB910	1/21,3/ 44	29GTL	3/45
CB920	1/21	29XLR	1/20
CB930	1/21,3/ 44	32XLR	3/58
CB950	3/43	46XLR	3/43
CBR9600	2/42,3/ 41	47XLR	3/45
CBR9940	3/44	50XLR	3/43
CHANNEL MASTER CB6835	6/18	55XLR	3/43
CHRYSLER 4048076/8077	6/18	78XLR	4/49,6/19
		78X	8/44
		86XLR	3/45
		87GTL	6/19
		89GTL	6/18
		132XLR	3/45

SPECIFIC RADIO TUNEUPS (Cont'd):

<u>RADIO</u>	<u>VOL/PG</u>	<u>RADIO</u>	<u>VOL/PG</u>
COBRA 135XLR	3/45	GEMTRONICS GT44	2/42
139	1/20	GT55	3/48
140GTL	3/20,58,	GTX66	6/21
	4/50	GTX77	6/21
142GTL	4/50	GTX4040	3/48
148GTL	6/19	GTX5000	3/42
1000GTL	6/18	GM CBD-203	3/48
COLT 222	6/20	4120	3/46
290	3/40	4175	3/46
390	3/4		
480	3/8,58	HYGAIN VIII	3/59
485	3/8,6/19	674A	4/60
800	3/4	V674B	1/21
1000	3/8,58	2701	2/42
COMMANDO 2340	1/21	2702	3/48
CONVOY CON-400	3/58	2703	3/48
COURIER BLAZER 40D	3/58		
CLASSIC PLL 40	3/43	ITT 4400M	4/17
FANFARE 125F	3/43		
FANON ROGUE 40	3/43	JOHNSON 123A	1/21
NIGHTRIDER 40DR	3/46	VIKING 260/270	3/49
RANGLER 40D	3/58	MESSENGER 50	7/51
REDBALL	1/21	MESSENGER 80(242-0080)	
RENEGADE 40	3/46		7/51
CRAIG L101	6/20	MESSENGER 4120	3/47
L102	6/20	MESSENGER 4135	3/48
		MESSENGER 4140145	3/54
DELCO 70BFMC3	2/43	4170/75	3/47
80BCB2	6/20	MESSENGER 4250	3/48
FANON 10-40	6/20	KRACO KCB-2340	2/42
FANFARE 182F	3/41	KCB-4003	3/42
FANFARE 184DF	3/47	KCB-4020	3/49
FANFARE 185PLL	3/46	KCB-4030	8/44
FANFARE 190DF	3/47,7/	KCB-4088	3/50
	51	KRIS XL25	2/43
FANFARE 350F	3/47		
		LAFAYETTE HB640	2/43
GE 3-5800A	3/50	TELESTAT 1240	5/14
3-5804B	6/21		
3-5814B	6/21	MEDALLION 63-240	3/50
3-5817A	7/51	MIDLAND 150M	7/52
3-5818A	2/42	13-893	4/51
3-5821B	3/54	76-858	3/49
3-5830	3/42	76-863	3/50
3-5869A	2/42	77-101B	8/44
3-5871B	3/46	77-821	3/42

SPECIFIC RADIO TUNEUPS (Cont'd):

<u>RADIO</u>	<u>VOL/PG</u>	<u>RADIO</u>	<u>VOL/PG</u>
MIDLAND 77-824	8/44	REALISTIC TRC-454	8/45
77-849	3/50	TRC-455	3/60
77-861	3/50	TRC-461	3/51
77-963	3/42	TRC-466	3/51
79-892	3/49	TRC-468	3/57
79-893	2/20	TRC-471	8/45
4001 (77-004)	7/52	TRC-480	7/53
MOPAR 4094173	3/51	ROBYN WV110	3/56
4094176	3/51	LB120	3/52
4094177	3/49	DG130D	3/56
4094178	3/60	007-140	3/52
MOTOROLA T4000A/05A/10A/ 20A	3/50	T-240D	3/56
NDI PC-200	7/52	SX-401	3/57
PACE 8008	2/43	SX-402D	3/57
8193	7/52	GT-410D	3/57
PALOMAR 49	3/60	AM500D	3/52
500	4/19, 5/ 32	SB-505	5/42
4100	3/54	SB-520D	2/22
PEARCE SIMPSON LEOPARD B	3/49	ROYCE 604	3/56
SUPERTIGER 40A	3/60	1-617	3/52
PRESIDENT ADAMS	2/16	1-619	3/56
WASHINGTON	1/22	1-621	3/57
JAMES K.	7/53	1-625	3/56
RCA 14T300	2/43	1-641	3/60, 4/51
14T302	3/53	1-651	7/55
REALISTIC TRC-45A	4/37	1-660	2/42
TRC-47	1/21	1-673	3/52
TRC-57	1/21	1-675	3/53
TRC-100	4/37	1-680	3/52
TRC-99A	4/37	SBE 26CB1A	3/61
TRC-180	4/37	42CB CORTEZ 40	3/61
TRC-200	4/37	45CB TRINIDAD III	3/61
TRC-421	8/44	47 CB	3/53
TRC-422	8/45	49CB TAHOE 40	3/53
TRC-424	3/57	43CB	3/53
TRC-425	7/53	SEARS CM-6000LA	3/59
TRC-427	8/45	CM-6000LC	3/59
TRC-431	4/37	Roadtalk 40	2/43
TRC-440	8/45	370-38050700	3/54
TRC-448	3/51	562-38200700	3/55
TRC-449	3/51	663-38020800	7/53
TRC-452	1/21, 3/ 52	663-38070700	3/61
		934-38120700	3/61
		934-38260700	7/53
		934-38270700	7/54
		934-38310700	7/54, 55

SPECIFIC RADIO TUNEUPS (Cont'd):

<u>RADIO</u>	<u>VOL/PG</u>	<u>RADIO</u>	<u>VOL/PG</u>
SHAKESPEARE GBS240	3/53	TEABERRY STALKER V	7/55
SHARP CB-800	2/42	STALKER XII	7/56
CB-4670	7/55	TRAM D12	3/54
SONAR FS-2340	5/31	TRUETONE CYJ4832-A-87	2/43
SPARKOMATIC SR42/CBM	3/54	CYJ4837-A-87	3/59
SURVEYOR 2610	3/54	TRS CHALLENGER 850	7/55
2620	3/55		
TEABERRY MODEL T	3/55	UTAC TRX-400	3/59
COMMAND	3/55	TRX-500	3/56
T DISPATCH	3/55	VECTOR X	2/43
RACER T	3/55		
STALKER II	1/21	WARDS GEN-775A	3/61
STALKER III	7/55		

VOLUME 1

	<u>PAGE #</u>
CRYSTAL CROSS REFERENCE GUIDE	5-10
LETTER CHART FOR CRYSTAL FREQUENCY CORRELATION	11-18
GENERAL INFORMATION	63-67
LINEARS	68-70
40 CHANNEL PLL SWITCH	71,72

VOLUME 2

NEW CRYSTAL CROSS REFERENCE GUIDE	5-9
LETTER CHART FOR CRYSTAL FREQUENCY CORRELATION	10-13
ANTENNA REPORTS	53-55
BETA-COM INFO (upgrading 23 channel radios)	57-87

VOLUME 3

SUPER MOD. IV (Frequency Counter Kit)	16-18
MICROPHONE WIRING INSTRUCTIONS	26-32
PLL CHANNELIZER	33-40
ANTENNA SECRETS (K40 Stud Mount for Big Stick)	63,64
SPECIAL SECTION ON LINEAR AMPLIFIERS:	
50-70W MOBILE	66
300-400W BASE	67-69
70W BASE	70,71
EAGLE 200	72
EAGLE 500	73
CONVERSION FROM AMATEUR TRANSMITTER TO LINEAR AMP	74
LINEAR AMP PROBLEMS & SOLUTIONS	75,76

SECRET CB INDEX (Cont'd):

VOLUME 4

	<u>PAGE #</u>
HOW TO BUILD YOUR OWN RELAY MODULE	16
02A CHIP INFORMATION	54,55
TURNER MIC EXPANDER (500 AMC DISABLE)	62
K40 BLINKIE	63
SUNSPOT PREDICTION CHART	64
LINEAR REPORT SECTION	
D & A MAVERICK	65
D & A 500 TRIPLE CONVERSION	65
EAGLE 515 MODIFICATION	66,67
UNIDEN SSB 10 METER POWER CONVERSION	68-70
SUPER CLARIFIER DIODE	71

VOLUME 5

10 METER CONVERSION MICROCOMPUTER (MICROMONITOR PLL)	1-5
ECHO BOX	6
250 WATT DUMMY LOAD	7
BUILT IN POWER MIKE	8,9
5-MILE SIMULATOR	10
RECEIVER PREAMP	11
GLEN DIGITAL CONTROLLER	12,13
GETTING SWR DOWN ON BASE ANTENNAS	15
APARTMENT ANTENNA	16
GROUNDING MOBILE RADIOS	17
OOPS! WE GOOFED (corrections for volumes 1-4)	17,18
THE ART OF WIDEBANDING 858 CHIP	44
CONVERSION KIT + MARS & CAP FOR SSB	48,49
CONVERSION OF AM/SSB TO 10 METER AMATEUR	52
REDCO UFO INSTALLATIONS	61-70
SLIDE INCREASE, ALL SSB RADIOS	71
RADAR COMMUNICATOR	71

VOLUME 6

PLL CRYSTAL CROSS REFERENCE GUIDE	1,2
SECRET CB TEST TONE	13
ERRONEOUS SIGNAL LOCATOR	14
LOW COST AMATEUR CONVERSION FOR 10 METERS	15
BASE ANTENNA GROUNDING	16,17
SUPER CLARIFIER 10-TURN POT	22
OOPS! WE GOOFED (corrections for volume 5)	25
THUMBWHEEL 200 CHANNEL CONVERSION FOR 858 CHASSIS	31-34
REDCO UFO APPLICATIONS	40-52

VOLUME 6

	<u>PAGE #</u>
SPECIAL SECTION ON LINEAR AMPLIFIERS:	
PDX 400	54
D & A MAVERICK 250	55
MACO DUSTER 300, 750 & 1000 TRANSMITTER	56,57
MACO 75	58
500 CX & 700CX 10 to 11 METER CONVERSIONS	58
RDX-75	59
HDX-50	59
MDX-200	60
PDX-400	61
10 METER EXPERIMENTER BOARD INFORMATION	62,63
SUPER CLARIFIER HINTS	66
REDCO DX-50	68-70

VOLUME 7

HOW TO MAKE YOUR EAGLE SCREAM	14
IMPROVED SLIDE MODIFICATION FOR 02A SSB RADIOS	42
UPDATED 200 CHANNEL AMATEUR CONVERSION FOR 858 CHIP	43-48
10 METER CONVERSION FOR SSB RADIOS USING MB8719 CHIP	49-50
HOW TO MAKE YOUR 858 CHASSIS SLIDE	56
LINEAR AMPLIFIER NOTES	57-59
ECHO BOX SPEECH PROCESSING FOR TRC-449	60
ADDING PING	61
CORRECTION TO THUMBWHEEL 200 CHANNEL CONVERSION	62,63
MICROMONITOR TECH NOTES	64-69
MICROMONITOR INSTALLATION INSTRUCTIONS FOR RADIOS USING 858 CHIP	70,71
AMP FOR RF PROBE	72
OSCILLOSCOPE MODIFICATION FOR RF & MODULATION DISPLAY	73
THE "BANDIT" ANTENNA	74-76
EXPO 100 KIT	76
SECRET CB's OWN "TROUBLESHOOTER"	77

VOLUME 8

WHAT'S NEW ON THE ELECTRONICS HORIZON?	1-6
UHF FM CB (GMRS)	7-10
UNIDEN MB8719 PLL CHIP FREQUENCY CONVERSION	15
FREQUENCY MOD. FOR JC PENNY, COLT, LAFAYETTE, HYGAIN, ETC.	18
BROWNING MKIVA MOD. & UFO INSTALLATION	22,23
BROWNING MKIV TRANSMITTER TROUBLESHOOTING	25-32
OOPS! WE GOOFED (corrections for volumes 5 & 7)	41-43
LINEAR AMPLIFIER NOTES:	
Installing & Troubleshooting Linear Amplifiers	47-49
10 Meter Amp Board Modification to Upright Driver	50
YOU CAN BUILD IT	
Two-Tone Generator	51
Yaesu 601(B) Frequency Counter Modification to Read CB Low, Middle, High Frequencies	52-54

	<u>PAGE #</u>
YOU CAN BUILD IT:	
RF Test Meter	56,57
REDCO UFO MODIFICATION (from 20 to 29.995 MHz)	55
SECRET CB'S POWER VECTORING	58
HOW THE ECHO BOX CAN ACTUALLY SURPASS THE POWER OF A LINEAR IN SSB	59
MICROMONITOR QUESTIONS	60,62
MICROMONITOR INSTALLATION INSTRUCTIONS:	
SM5104 PLL	63,64
ICOM 22S	65-67
NEW PRODUCT RELEASES:	
Zapper 9000	68,69
Redco Digi-Scan UFO Elite	70
Chopper Charlie Antenna, Model 64#5	71
Troubleshooter	73

* * * THIS SPACE FOR YOUR NOTES * * *

New Book Release



SELMAN ENTERPRISES, INC.
P. O. Box 8189
Corpus Christi, Texas 78412

SEE YOUR LOCAL CB DEALER OR ORDER DIRECT



Volume I



Volume II



Volume III



Volume IV



Volume V



Volume VI



Volume VII



Volume VIII



Volume IX



SECRET CB ORDER FORM

SELMAN ENTERPRISES, INC.
P. O. Box 8189
Corpus Christi, Texas 78412

- | | |
|---|--|
| <input type="checkbox"/> \$12.95 Vol. I | <input type="checkbox"/> \$12.95 Vol. V |
| <input type="checkbox"/> \$12.95 Vol. II | <input type="checkbox"/> \$12.95 Vol. VI |
| <input type="checkbox"/> \$12.95 Vol. III | <input type="checkbox"/> \$15.95 Vol. VII |
| <input type="checkbox"/> \$12.95 Vol. IV | <input type="checkbox"/> \$15.95 Vol. VIII |
| | <input type="checkbox"/> \$15.95 Vol. IX |

SHIP TO:

Phone 512 992-1303 If You Wish To Order by Phone

Name _____

Address _____

City _____ State _____ Zip _____

Ship Via: UPS First Class Parcel post Other _____
Send Check, M.O. or C.O.D. only. Add \$1.00 per book for shipping. Visa, Master Charge accepted. Add 3% for handling.

SECRET CB[®]

