

SECRET CB[®]

CONFIDENTIAL
FACTUAL
REPORT
SCHEMATICS ETC.
UPDATED QUARTERLY

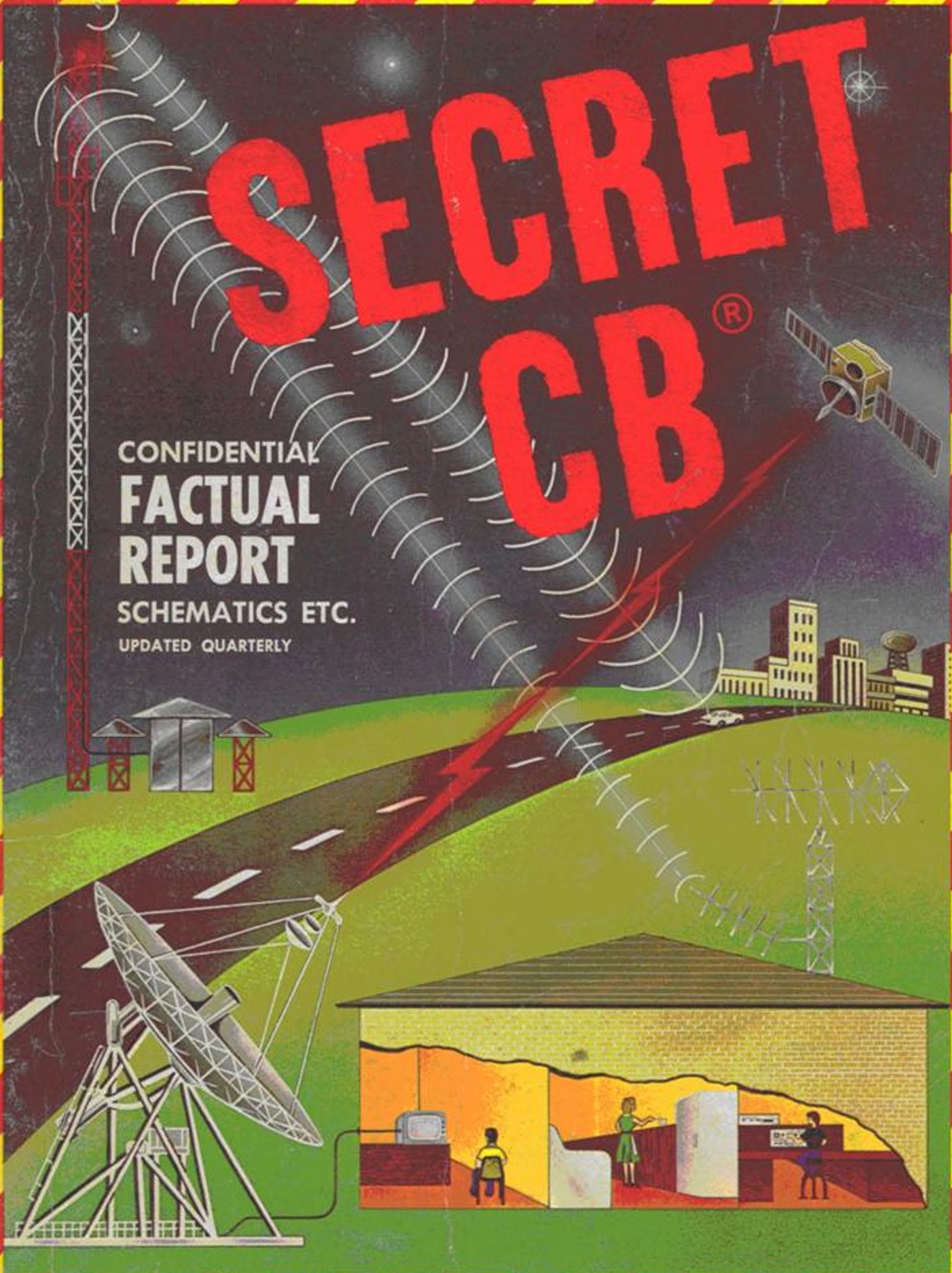

IMPORTANT: READ THIS FIRST

The information in this book is not to be used to exceed F.C.C. specifications, in any case, as applied to power, modulation, frequency spectrum, etc. It is illegal to do this to any CLASS D RADIO.

This book is a factual report of gathered information, and as such is intended for use on radios for EXPORT ONLY.

If you are not familiar with electronics, it is better to check for advice with your local electronics or CB center, as to restrictions, etc., concerning your radio.

More information, on other units will be forthcoming in future issues, to be published on a quarterly basis.

This book will not be found at a book store, but can be obtained through your local CB Dealer or Distributor, or by completing the order form in the book and sending to:

Selman Enterprises, Inc.
P.O. Box 8189
Corpus Christi, Texas 78412

Secret CB
Volume Eight
Published May, 1980

Copyright 1980. All rights reserved in the United States and most foreign countries.

New issues quarterly

Address any and all inquiries to:

Selman Enterprises, Inc.
P.O. Box 8189
Corpus Christi, Texas 78412

(512) 992-1303

INTRODUCTION

Well, here we are in Volume 8 and I'm glad that there are still readers out there that encourage us to keep writing Secret CB.

Secret CB is a confidential, factual report written as an aid to help the laymen and technicians who wish to experiment in electronics.

The other day a gentleman called me and told me that Secret CB was a "bunch of bull" - well not exactly in those terms. On-going with the conversation, he also stated that he knew almost all the info printed. After listening closely, I picked out the words "almost all" and asked the gentleman how much was "almost" and he said, "Well, you had a few ideas that I didn't know in the book." I asked how much the info had been worth to him and reminded him that Secret CB is only a confidential factual report! He replied "On the last book about \$150 - why?" I replied, "If you will keep reading Secret CB, I'll try to write a better volume next time. Thank you for calling!"

Enough humor. Secret CB is truly grateful to those of you who have contributed your own information to our book. Writing Secret CB every four months is comparable to coming up with several hundred new inventions each issue. The material is controversial, explosive, and sometimes far-reaching to even the most imaginative reader. One page of info in any of the Secret CB books could well be worth the cover price and more.

Communications is still booming, and many innovations have been introduced since the onslaught of CB. Many people "rode the bandwagon" when CB was "booming out of hand". However, what is left is a handful of customers and dealers who service CB's, and are serious about their hobby! Since the price of gasoline has increased out of sight, more people are going to "make the trip by radio". No longer will the excuse be given that a two-way system is too expensive. To the CB dealer who never thought of getting into the FM two-way business, you might consider this as the time to invest in this new venture. To the customer, FM two-way can save you gas, time, and increase your productivity. How many times have you driven across town when you needed to talk to your shop, office, or other business associates? Sometimes during the day, an ordinary CB cannot "make the trip", due to sunspot activity - FM CB could be in your future.

Now, the author, wishes to stick his neck out, and predict the biggest boom in electronics ever to hit the market. If you haven't already guessed, it's Satellite Earth Receiving Stations!

INTRODUCTION (CONT'D)

Kits, books, and turnkey systems are already available. Receiving up to 24 TV stations from a satellite 22,300 miles away is now reality! We hope you will read our new book, Secrets of Satellite TV, written for the hobbyist and professional alike. Dish antennas, kits, and turnkey systems will be available from us and our participating dealers and distributors. Until Volume 9 I remain _____

Sincerely

Rodney L. Johnson
73's



TABLE OF CONTENTS

	<u>PAGE #</u>
What's New on the Electronics Horizon?	1-6
UHF FM CB (GMRS)	7-10
10 Meter Conversion For Tram D300	11-13
SBE Console VI & Sidebander VI Amateur Conversion	14
Uniden MB8719 PLL Chip Frequency Conversion	15
Cobra 148 GTL Channel & Clarifier Modification	16
Frequency Expansion For Cobra 29GTL, 87GTL, 89GTL & 1000GTL	17
Frequency Mod For JC Penny, Colt, Lafayette, Hygain, Etc.	18
Superscope Aircommand CB340	19
Hygain II 23 Channel Modification	20
Palomar SSB-500 Update, CPI CP300, 400 Update	21
Browning Mark IVA Modification & UFO Installation	22,23
Frequency Modification For JC Pennys 6248 SSB	24
Browning Mark IV Transmitter Troubleshooting	25-32
 <u>SLIDE MODIFICATIONS:</u>	
Dual Range Slider For President Washington (New)	33,34
Slide Modification For President Grant (New)	34
How To Make Your Cobra 142GTL Clarifier Slide	35-37
Cobra 135XLR Clarifier Update	38
Mike Gain Control & 10-Turn "Fine-Tuning" Clarifier For Realistic TRC-458	39,40
 OOPS! WE GOOFED! (Corrections for Volumes 5 & 7)	 41-43
 SPECIFIC RADIO TUNE-UPS	 44,45
 LINEAR AMPLIFIER NOTES	 46
Installing & Troubleshooting Linear Amplifiers	47-49
10 Meter Amp Board Modification to Upright Driver	50
 YOU CAN BUILD IT	
Two-Tone Generator	51
Yaesu 601(B) Frequency Counter Modification to Read CB Low, Middle, High Frequency	52-54
RF Test Meter	56,57
Redco UFO Modification	55
Secret CB's Power Vectoring	58
How The Echo Box Can Actually Surpass The Power Of A Linear In SSB	59
Micromonitor Questions	60-62
Micromonitor Installation Instructions, Sears Roadtalker Series, JC Pennys, Using SM5104 Chip	63,64
Icom 22S Micromonitor Installation	65-67
NEW PRODUCT RELEASE - Zapper 9000	68,69
NEW PRODUCT RELEASE - Redco Digi-Scan UFO Elite	70
NEW PRODUCT RELEASE - Chopper Charlie Antenna Model 64#5	71
NEW PRODUCT SURVEY - "Troubleshooter"	73
SECRET CB INDEX - Volumes 1 - 7	74-81

WHAT'S NEW ON THE ELECTRONICS HORIZON?

Attention, Secret CB readers. If you really want to get your feet wet in state-of-the-art technology, the author of Secret CB will be introducing yet another periodical book dealing with home satellite TVRO (television receive only) earth stations. This book, to be published semi-annually, will bring you in touch with the current new developments and technical developments in the field of satellite reception. There will be articles on how to build your own earth station for a fraction of the cost of "turnkey" systems, and for those who want to get into the space-age fast - articles and descriptions of off-the-shelf components that can be "plugged together" to give you almost instant access to seven satellites now operating in geostationary orbit.

We will explore how to get four HBO channels off RCA's SATCOM I satellite - how to get pictures off the TIROS weather satellites, and interesting articles on what the "big boys" of the industry are doing - or trying to do.

You will be given proven experimental projects in antenna fabrication, circuit construction (from scratch), and have access to ALREADY AVAILABLE circuit boards, kits and components.

The first issue (scheduled for publication in May, 1980), will feature an introductory article on satellite technology and a glossary of terms that will be used in future publications. There will be listings of "turnkey systems" and components, etc. In general, it will be a gangbuster "get your feet wet" book on home satellite earth stations - one that you'll want to read - even if you don't shoot for the stars right away. You'll be informed about the systems that provide sports from Olympic games half-way around the world in terms that a neophyte or more technically oriented reader will find both educational and interesting. And, as an unquestionable feature - virtually every reader, regardless of his technical involvement in the satellite field will LEARN with each issue.

The following is an explanation of how a satellite system actually works, and concluding the feature, you'll find information on where to make dealer and/or consumer inquiries.

HOW THE EARTH STATION WORKS

ORIGINATION & UP-LINK

The origination of satellite TV signals is usually in studios or various facilities at many different locations (locations will be found in the back of this presentation). These signals are transmitted via terrestrial means (cable or microwave) to up-link satellite terminals located at many different sites throughout the United States. The up-link terminal consists of a large aperture (10 meters or larger) parabolic antenna which transmits to the satellite in the 5.9 to 6.4 gigahertz (GHz) band, using wideband FM. For wideband video transmission, the up-link terminals transmit the signal in a 36 megahertz (MHz) bandwidth with sufficient power to fully saturate the satellite transponder.

SPACE SEGMENT (SATELLITE)

The space segment of the signal chain consists of a geostationary satellite located approximately 24,000 miles above the equator. This satellite orbits the earth at the same speed as the earth revolves, so in effect, the satellite does not move in relation to the earth's surface (figure 1).

There are presently two types of satellites in orbit which are used for TV relay. They are the Western Union (WESTAR) satellites, and the RCA (SATCOM) satellites. While both operate in the same 500 MHz frequency bands, the Western Union satellites have 12 transponders, each 40 MHz wide and separated by 40 MHz, while the RCA satellites have 24 transponders each 40 MHz wide, but separated by 20 MHz. RCA is able to accomplish this by utilizing frequency re-use, or cross-polarization. Basically, this consists of 12 transponders vertically polarized and 12 horizontally polarized with each adjacent transponder being in the opposite polarization; i.e., odd-numbered channels vertically polarized, and even channels horizontally polarized (figure 1).

The satellite receives the 6 GHz signal transmitted from the up-link terminal, translates it to 4 GHz and re-transmits it back to the ground in a beam shaped to cover the geographic area of interest which, in our case, is the United States.

DOWN-LINK OR RECEIVE TERMINAL

The down-link terminal is that portion of the signal chain which is of importance to the system user. It is this part of the chain which the user can control, design, and own, and it is this part of the chain with which he must become familiar.

NEW HORIZONS (CONT'D)

There are three primary parts of the receive terminal:

- *Antenna
- *Low Noise Amplifier
- *Receiver

We shall now examine each of these components individually.

THE ANTENNA

As the first element in the receive chain, the contribution of the antenna to the overall system noise temperature and gain are of primary importance. For the purpose of this article, we will consider antenna sizes of 3 meters (10 feet) to 5.6 meters (18 feet).

PRIME FOCUS PARABOLIC ANTENNA

The prime focus feed parabolic antenna uses a feed element located at the apex or focal point of the parabolic "dish" to extract the RF energy. There are two types of prime focus feeds.

- a. The button hook feed which uses a section of curved waveguide to receive the RF energy at the apex and then couple it back to the vertex of the dish and into the low noise amplifier.
- b. The feed located at the apex, mounted on struts or supporting members.

The prime focus feed exhibits excellent side lobe performance, but usually has lower gain due to losses in the waveguide runs to the low noise amplifier, Type (a) above. Type (b) above overcomes this loss by locating the low noise amplifier at the vertex, but this configuration offers some disadvantage when changing or aligning polarization.

LOW NOISE AMPLIFIER (LNA)

The LNA is perhaps the singular most important element in the receive terminal. As the first active component in the system, its design and characteristics can change overall system performance more than any other. These amplifiers' noise performance is specified in degrees kelvin.

There are two basic types of LNA used:

GEOSTATIONARY SATELLITES

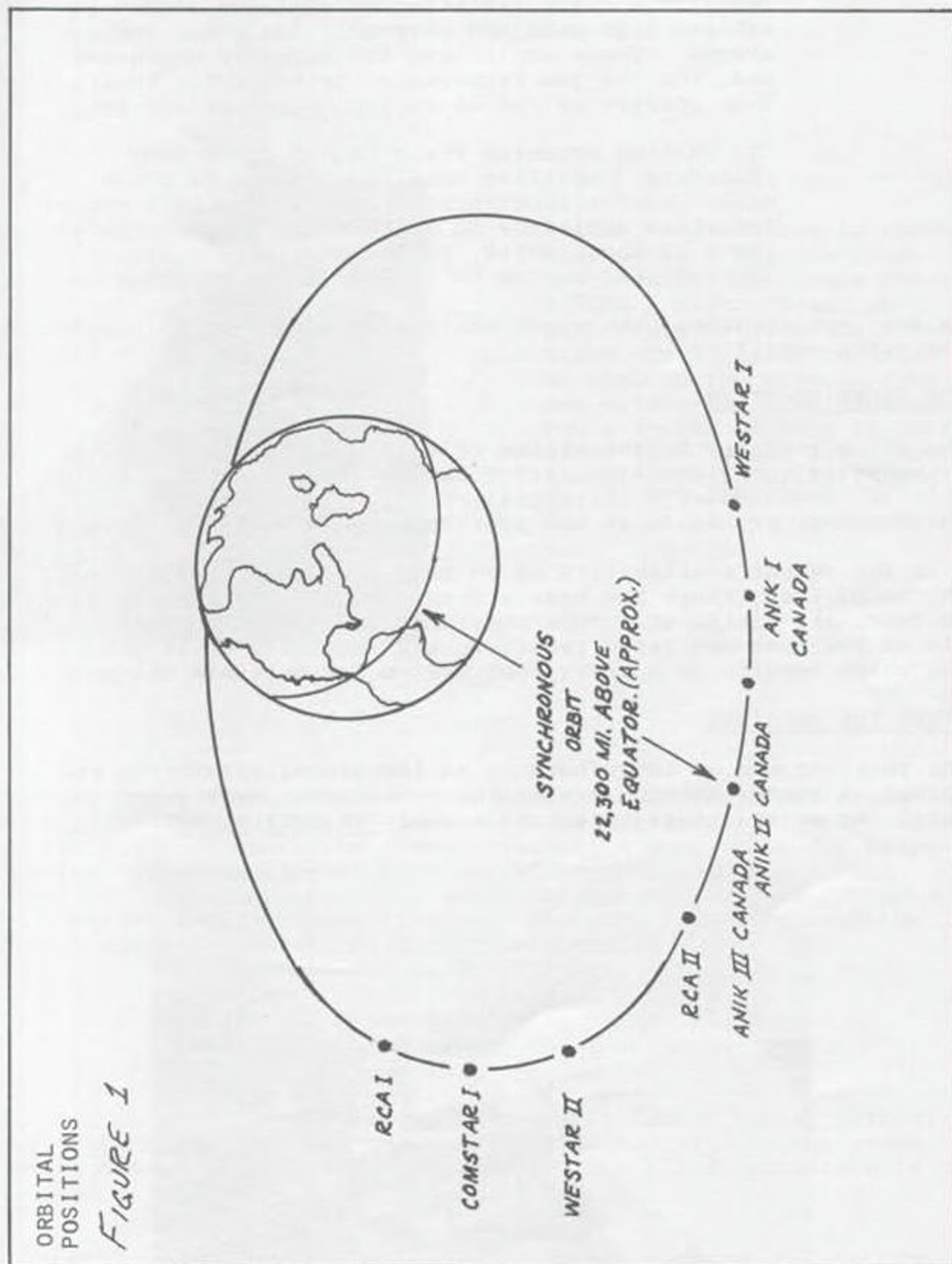

- a. The parametric amplifier makes use of the negative resistance characteristics or varactor diodes to achieve high gain and extremely low noise temperatures. These amplifiers are normally expensive and, for the low temperature units, quite bulky. They operate in the 45 to 120 degree kelvin area.
- b. The Gallium Arsenide Field Effect Transistor (GaAsFets) amplifier usually consists of a low noise GaAsFet input amplifier followed by a transistorized amplifier to achieve low noise temperatures of these units, while lowering the price. They operate in the 90 to 300 degree kelvin area.

In most applications, the earth station will employ the GaAsFet low noise amplifier.

THE VIDEO RECEIVER

The video receiver in the system selects the desired satellite transponder, provides attenuation and isolation for unwanted signals, down-converts the signal, extracts audio and video information, processes it and provides inputs to the modulator.

With the recent availability of so many different signals from the satellites, there has been a change in philosophy in regard to receiving equipment. Some manufacturers are now offering a mix of low cost dedicated receivers and frequency agile receivers which results in a lower cost system for multiple channels.

AFTER THE RECEIVER

The receiver can be interfaced to an individual television receiver, a master antenna system (so as to serve many receiving sets), or as an integral part of a cable television system.





Author, Rod Johnson is shown here using a Brunton hand-held transit to locate the SATCOM I bird. Exact azimuth and elevation calculations are required in order to pick up the signals from any satellite. (We'll show you a couple of ways to calculate this in the first volume of Secrets of Satellite TV).

If this isn't enough to whet your appetite, in the first issue of Secrets of Satellite TV there will be a glossary of terms used in the field of satellite communications; a more technical introduction, and characteristic prices of boards, components, and complete turnkey systems that are available through the publisher.

Dealer inquiries are invited. For more dealer information, please address a letter on your letterhead to:

Selman Enterprises, Inc.
P. O. Box 8189
Corpus Christi, Texas 78412

Or call: 512/992-1303

Attention: Rod Johnson (author)
or: George F. Blancett (contributing author)

Until the first issue of Secrets of Satellite TV hits the press, here's hoping you will find the same interest and enthusiasm in satellite TVRO systems that I have.

George

UHF FM CB (GMRS)

AND HOW TO GET INTO IT

The use of ultra high frequency (UHF) is no new game. FM UHF helps eliminate interference problems with other stations. The transmit power allowed is up to 50 watts and range up to 100 miles is possible, based on mobile-to-mobile contact. 8 frequencies are allowed on GMRS and license application should be submitted on form 400 to the FCC. Contact your nearest FCC field office for details concerning GMRS.

Normally (GMRS) UHF radios are available and are reasonably priced. Most are no larger than a CB. If you do not have a licensed technician, most radios can be ordered on frequency from distributors, dealers, or manufacturers.

There have been some articles on the subject, but most are complicated and leave a person in the dark. Secret CB will attempt to bypass a lot of the "bull and red tape" and explain just how to go about getting into this new field.

STEPS TO FOLLOW:

- (1) Obtain a Bearcat 210 scanner, or equivalent, and monitor the below frequencies:
 - Ch. 1 - 462.550
 - Ch. 2 - 462.575
 - Ch. 3 - 462.600
 - Ch. 4 - 462.625
 - Ch. 5 - 462.650
 - Ch. 6 - 462.675
 - Ch. 7 - 462.700
 - Ch. 8 - 462.725

Monitor for at least 3 days or so and find a channel not used or not busy in your area.

- (2) Apply for FCC license on Form 400 to the FCC or contact:

Mr. Jim Campbell
Communications Advisors of Texas
P. O. Box 4177
Corpus Christi, Texas 78408

or phone: 512/992-8425

He can take all the hassle out of all the FCC licensing work and design a radio system for your needs. Jim normally charges approximately \$50 a license to file for you. You might give him a call as to your FM 2-way communications needs.

UHF FM CB (GMRS) (CONT'D)

- (3) Apply for license after you have obtained permission or have a location for your repeater. Normally a tower will be available for you to rent space on. Again, I suggest calling Jim for more information.

Below is (GMRS) Frequency channelization:

CHANNEL MODE	OPERATING FREQUENCY (MHz)		
	TX	-	RX
REPEAT	467.550	-	462.550
DIRECT	462.550	-	462.550
REPEAT	467.575	-	462.575
DIRECT	462.575	-	462.575
REPEAT	467.600	-	462.600
DIRECT	462.600	-	462.600
REPEAT	467.625	-	462.625
DIRECT	462.625	-	462.625
REPEAT	467.650	-	462.650
DIRECT	462.650	-	462.650
REPEAT	467.675	-	462.675
DIRECT	462.675	-	462.675
REPEAT	467.700	-	462.700
DIRECT	462.700	-	462.700
REPEAT	467.725	-	462.725
DIRECT	462.725	-	462.725



THE REPCO REPEATER
SHOWN WITHOUT CABINET DUPLEXOR

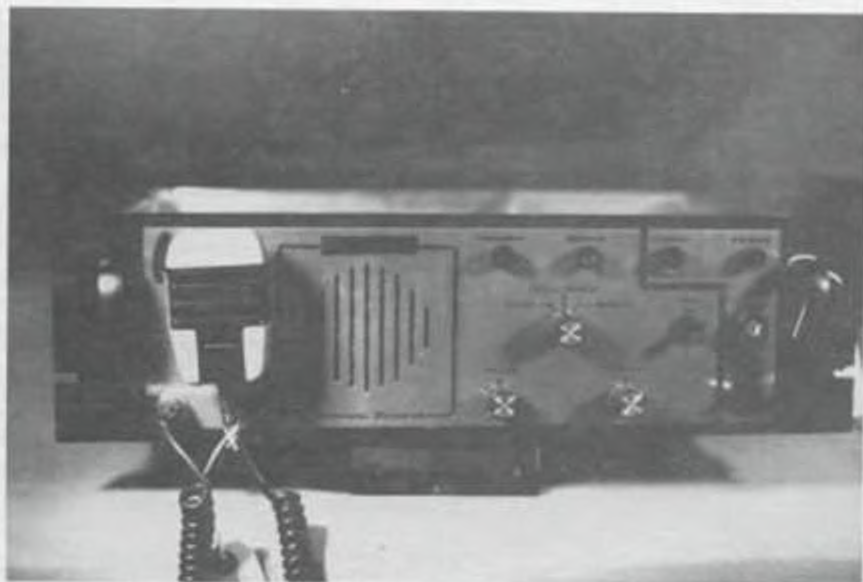

This is the REPCO Repeater, hailed to be one of the finest on the market in its price range. Featuring all modular construction, 100% solid state, time-out timer, automatic transfer AC to DC, and more. Power output is 25 watts.

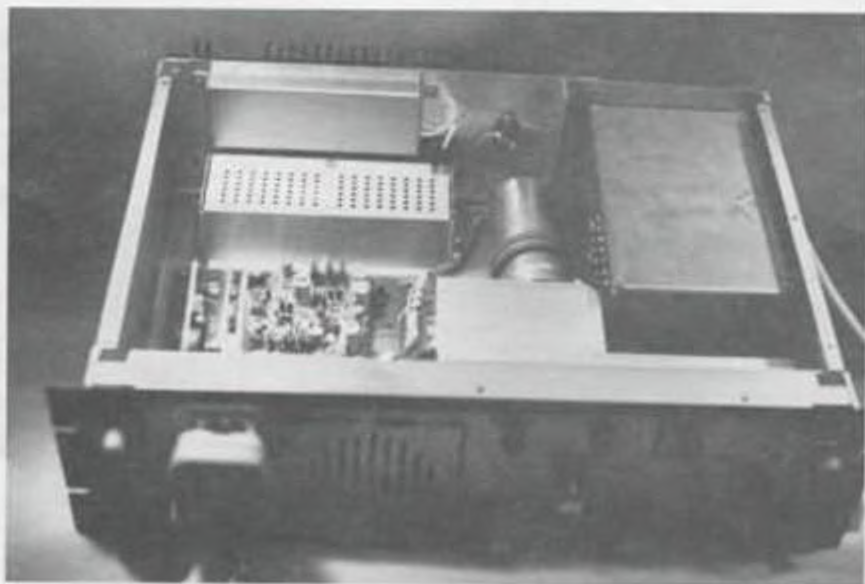

INSIDE THE REPCO REPEATER

TYPICAL UHF GMRS OR BUSINESS BAND REPEATER

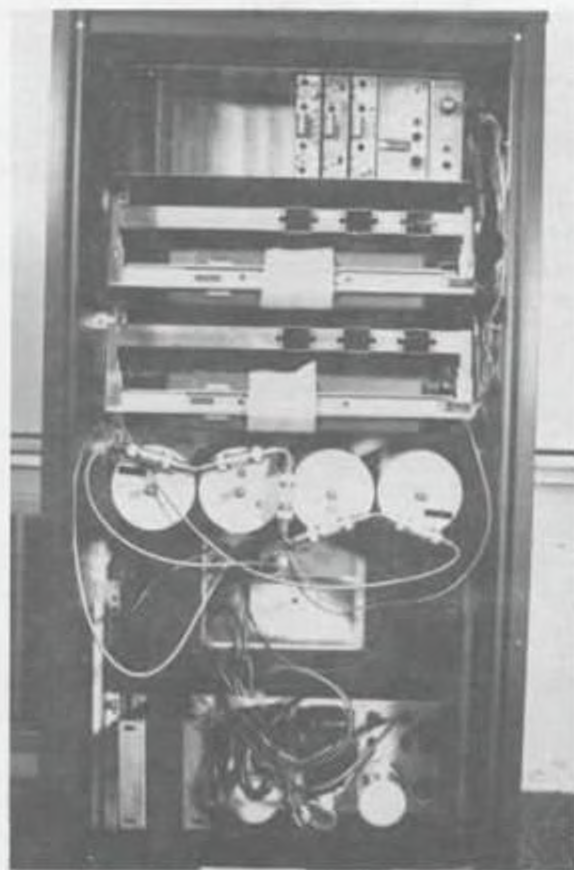

TONE BOARDS, TIME OUT
CIRCUITS, ETC. NOTE
PLUG-INS TO HOLD AD-
DITIONAL TONE BOARDS,
EACH PLUG-IN HAS 4 TONES.

TRANSMITTER

RECEIVER

DUPLEXOR

POWER SUPPLY

JOHNSON CR1000 UHF
REPEATER

YOU CAN PUT UP TO 16 COMPANIES ON EACH REPEATER AND CHARGE EACH COMPANY UP TO \$45 A MONTH AND MORE, DEPENDING ON USE AND HOW MANY MOBILES, EVEN THOUGH THE JOHNSON REPEATER COSTS A LITTLE MORE, ITS AN EXCELLENT TROUBLE-FREE UNIT, INTERMODULATION IS ALMOST NON-EXISTENT, THERE ARE MANY FINE REPEATERS ON THE MARKET, THE CHEAPER THE UNITS THOUGH, MEANS MORE FAILURES AND/OR INTERMODULATION PROBLEMS,

THE TRAM LIVES ON BUT IN SHORT SUPPLY

Tram has always been a fine choice in the SSB CB circles. However, I understand that the company no longer builds this unit, or has limited supply at the time of this issue of Secret CB. We also understand that some distributors still have a healthy stock of the units. They are a fine radio with a chassis comparable to the President Madison. The broad tuning capabilities of this unit are fantastic. Good luck to those of you who are fortunate to own, hopefully, not the last of the Tram D300's.

Many thanks to "Abe" of CLERCOM, INC., Williamsburg, Ohio, whom I've know for some time and who is a personal friend. He made possible the pictures of the Tram D300.

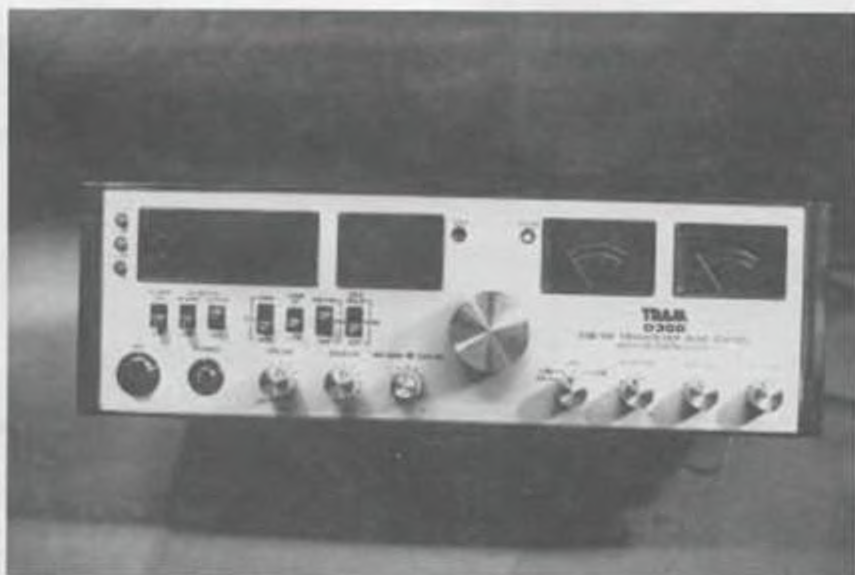

10 METER CONVERSION FOR TRAM D300

AND SIMILAR CHASSIS USING MB8719 CHIP

NOTE: SEE VOLUME 7 SECRET CB FOR TUNEUPS & SLIDE MODIFICATIONS.

2POLE 6 POSITION ROTARY SWITCH

ALL DIODES IN914

NOTE: THIS SWITCH DIAGRAM IS A CORRECTION OF THE DIAGRAM FOR THE COBRA 2000 AND MB8719 MODIFICATIONS IN VOLUME 7 SECRET CB.

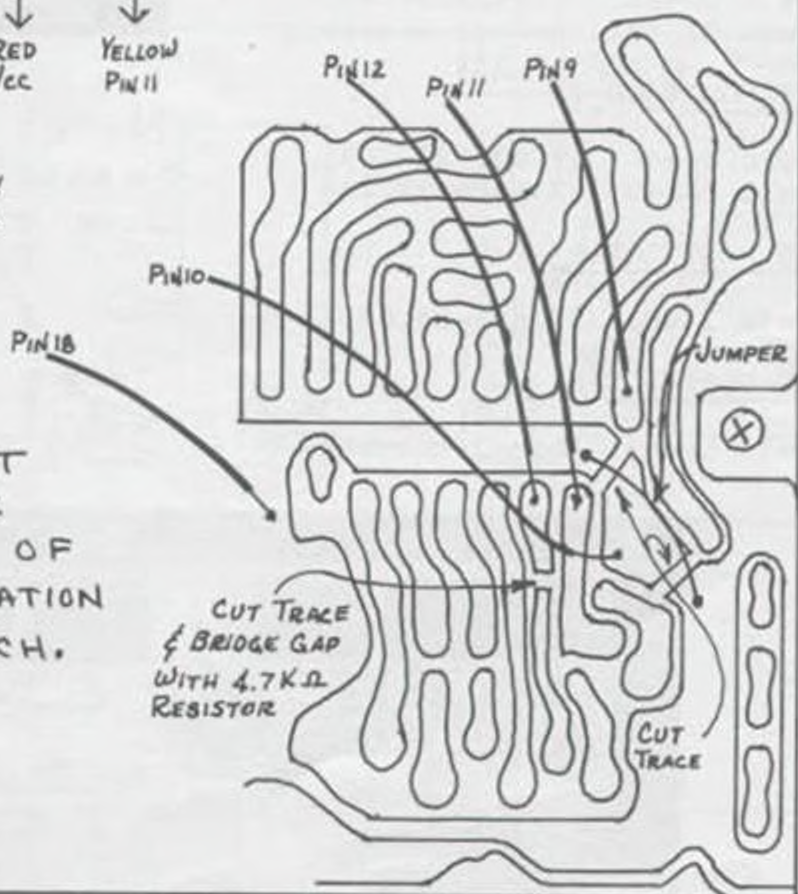
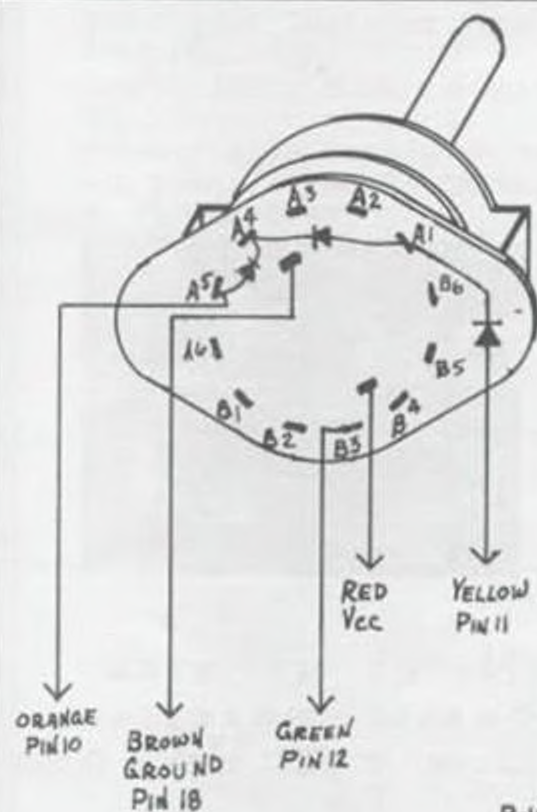

◆ SEE NEXT PAGE FOR LOCATION OF GOOD LOCATION FOR SWITCH.

FRONT OF RADIO
(TRACE SIDE)

10 METER CONVERSION FOR TRAM D300 CONT'D.

FREQUENCY CHART

SWITCH POSITION 1:

Channels 1-14: Normal channels
Channels 15-32: 26.815 - 27.005
Channels 33-40: 27.015 - 27.085

SWITCH POSITION 2:

Channels 1-40: Normal channels

SWITCH POSITION 3:

Channel 1: 27.125
Channels 2-14: Normal channels
Channels 15-22: Channels 29-38
Channel 23: 27.415
Channels 24,25: Channels 39,40
Channels 26-28: 27.425-27.445
Channels 29-40: Normal channels

SWITCH POSITION 4:

Channels 1-14: 27.605-27.765
Channels 15-40: 27.455-27.725

SWITCH POSITION 5:

Channels 1-40: 27.605-28.045

SWITCH POSITION 6:

Channels 1-40: Normal channels



NOTE: NO XTAL
CHANGE NECESSARY
WITH THE TRAM D300

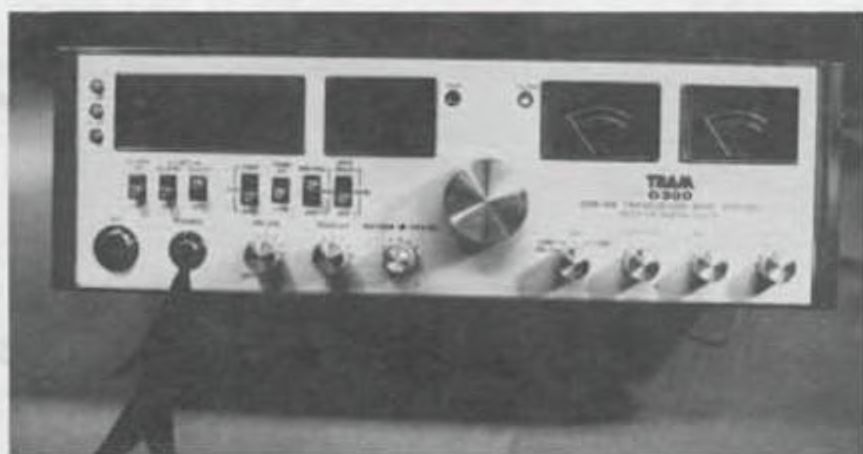

LOCATION TO BRING SHAFT OF
10 METER CONVERSION SWITCH THROUGH
CHASSIS WITHOUT DRILLING EXTRA HOLES.

SBE CONSOLE VI & SIDEBANDER VI

AMATEUR CONVERSION

1. Add IN4448 Diode near CPU on Main PCB as shown.
2. Add 0.22uF Tantalum Capacitor to rear of PLL PCB in parallel with C05.
3. Change 100pF Mica capacitor (C23 on PLL PCB) to 150pF Mica cap.
4. Connect high impedance input DC voltmeter to Pin 6 of IC03 & set transceiver to Channel 1. Adjust L01 for 3 volts DC.

CHANNEL FREQUENCIES:

Channel:	1 to 70	26.965 - 27.705 MHz.
	71 to 95	26.715 - 26.955
	96	26.995
	97 Australian Ch. 7	27.095
	98	27.145
	99 Australian Ch. 16	27.195

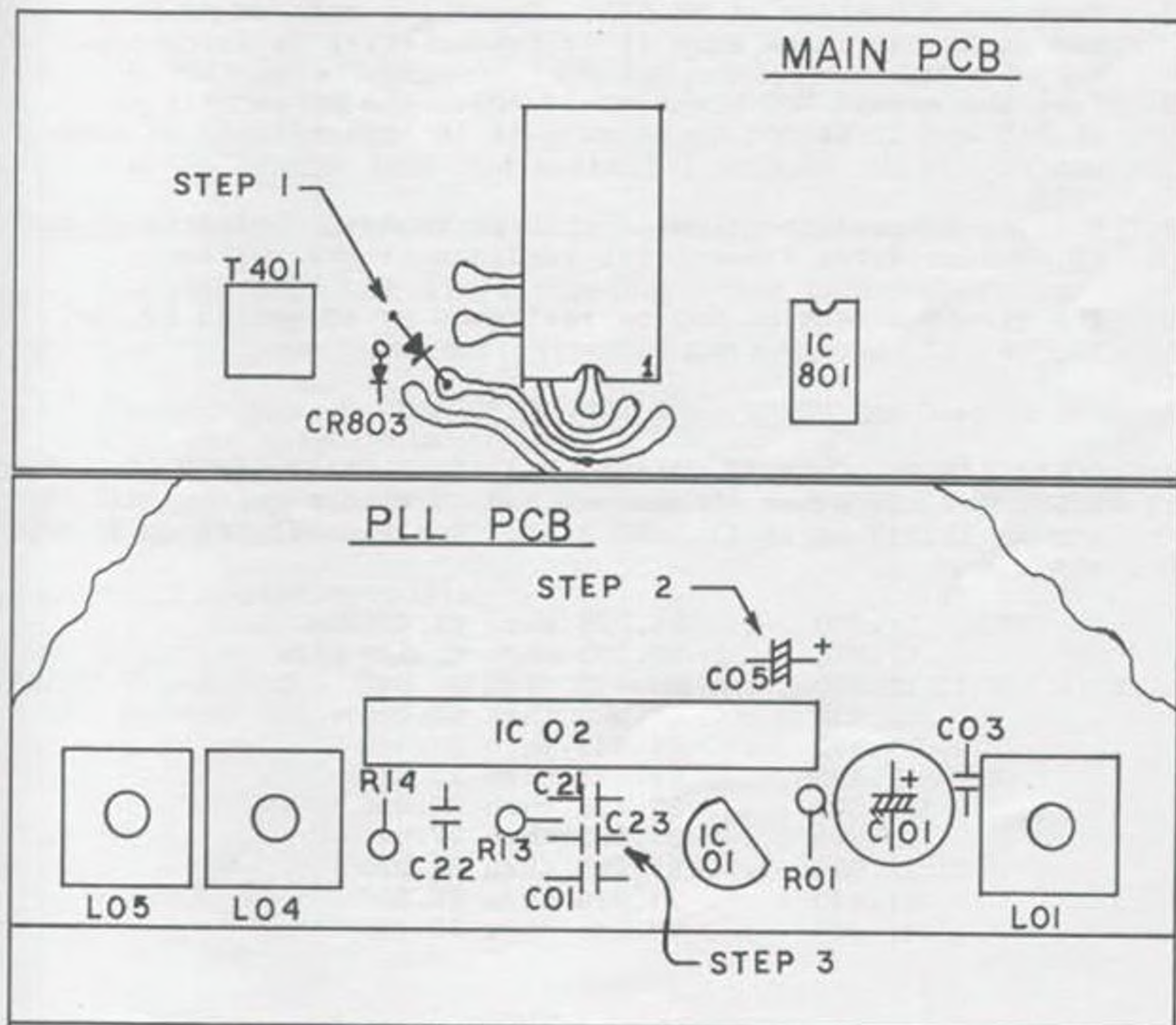

UNIDEN 8719 PLL CHIP FREQUENCY CONVERSION

FOR COBRA 140, 142GTL, etc.

1. Refer to Secret CB Volume 4, page 50 for power output, modulation, and clarifier modifications.
2. Obtain seven crystals: 10.300, 10.550, 10.700, 10.850, 11.000, 11.250, and a 11.400.
3. Secure a crystal box or a rotary switch.
4. Install the new crystals in the crystal box or on the rotary switch along with the original crystal. Keep leads short as possible.
5. Acquire an extra VCO block.
6. Install the original VCO block (L13) and the second VCO block on a switch (toggle or slide) or on a small piece of perf-board with a relay.
7. Tune one VCO block at 25.685. Check the unit at 24.825 and at 26.545 to be sure it is transmitting on frequency.
8. Tune the second VCO block at 27.405. Check the unit at 26.555 and at 28.265 to be sure it is transmitting on frequency.
9. Realign transmit section of unit at 26.545. Refer to Secret CB, Volume 4 for transmitter realignment instructions.
10. The receiver section may be realigned by adjusting L3, L4, L5, L6, L7, L8, L9, and L10.

PHASE LOCK LOOP CRYSTALS

COBRA 148GTL, COURIER GALAXY, PRESIDENT GRANT, TRAM D80, TRAM D300, and all other 40 channel radios with a Uniden 8719 chip and an 11.325 or an 11.3258 xtal. Replaces 11.325 or 11.3258 xtal.

XTAL	11.000	. . .	25.995	thru	26.435MHz
	11.050	. . .	26.145	thru	26.585
	11.150	. . .	26.445	thru	26.885
	11.200	. . .	26.595	thru	27.035
	11.450	. . .	27.345	thru	27.785
	11.495	. . .	27.475	thru	27.915
	11.500	. . .	27.495	thru	27.935
	11.505	. . .	27.505	thru	27.945
	11.600	. . .	27.795	thru	28.235
	11.640	. . .	27.915	thru	28.355
	11.650	. . .	27.945	thru	28.385

COBRA 148GTL CHANNEL & CLARIFIER MODIFICATION

NOTE: Refer to Secret CB, Volume 7 for drawings on Uniden MB8719 Chassis.

1. Remove R44, R174, R175 and D52.
2. Install jumper wire where you removed R175
3. Install jumper wire where you removed R174
4. Move orange wire on clarifier to empty hole on printed circuit board next to R137 (8.17 volts)

Note: L23(AM), L59(USB), L22(LSB), will have to be readjusted for center slot on Voice-lock control.

5. SSB Power VR11
6. AM Modulation: Cut collector of TR24 or remove.
7. AM Power: VR10
8. Transmitter alignment: L47, L48, L46, L45, L38. Do not touch L36 (TVI).
9. You can change TR36 and install a 2SC1307 final.
10. Remove R418 and all wires from Bright-Dim switch.
11. Tie red and black wires together, tape back white one.
12. Remove wires from tone switch, tape both back.
13. Connect ground (Pin 18 of PLL) to center terminal of both Tone and Bright-Dim switches.
14. Connect pin 10 of PLL to tone switch and pin 11 of PLL to Bright-Dim switch.
15. Modification complete

TONE SWITCH/HI will now go from 27.605 to 28.045
LIGHT SWITCH/BRT - TONE SWITCH/HI will now go from 27.455 to 27.725
LIGHT SWITCH/ BRT will now go from 26.815 to 27.005

FREQUENCY EXPANSION FOR COBRA 29GTL, 87GTL, 89GTL,
AND 1000GTL

1. Remove covers from unit.
2. Drill a hole and mount switch or use an existing switch.
3. Remove C87 in the Cobra 29GTL.
Remove C79 in the Cobra 87GTL, 89GTL, and 1000GTL.
4. Solder a wire from each hole the capacitor was removed from to the switch.
5. Solder the desired crystal or crystals to the switch. If one of these crystals is not switched into the circuit, you will have regular channels.
6. Choose from the list below:

FOR 11 METERS:

XTAL 14.455	26.060 through 26.500
XTAL 14.460	26.065 through 26.505
XTAL 14.905	26.510 through 26.950
XTAL 14.910	26.515 through 26.955
XTAL 15.805	27.410 through 27.850
XTAL 15.810	27.415 through 27.855

NOTE: 15.805 is used to obtain the Business Radio Frequencies 27.430, 27.450, 27.470, 27.490, 27.510, and 27.530.

The 14.905 may be used to obtain the Civil Air Patrol frequency 26.620.

FOR PETROLEUM RADIO SERVICE:

XTAL 13.405	25.010 through 25.450
XTAL 13.415	25.020 through 25.460

FOR 10 METER AMATEUR RADIO:

XTAL 16.395	28.000 through 28.440
XTAL 16.455	28.060 through 28.500
XTAL 17.360	28.965 through 29.405

FOR FOREST PRODUCTS RADIO SERVICE:

XTAL 17.805	29.410 through 29.850
-------------	-----------------------

NOTE: The 17.805 is used to obtain 29.710, 29.730, 29.750, 29.770, and 29.790.

FREQUENCY MOD FOR JC PENNY, COLT, LAFAYETTE, HYGAIN, ETC.

NOTE: This modification works on the J.C. Penny 6241, Colt 480, 485, 1000, 1200, Lafayette SSB 140, HB120, Hygain VIII, V, and other similar chassis.

PARTS NEEDED:

Frequency Counter

Dummy Load (Secret CB's "Little Dummy" works great)

Several 20 - 30pF caps for padding

1 @ SPST switch (optional)

This modification allows you to work even or odd frequencies on AM or SSB. It allows, for example: Ch. 21 - 27.215, switch off. With switch on 27.210, drops .005KHz.

1. Go to test point #5 (off the emitter of Q44, and pick up the constant 9V source and run to a switch - put one in or use NB, PA, etc.
2. On other side of switch go to R14. After one end of the R14 resistor is removed from the 8.99 SSB volt source, attach a wire (careful, Q3 is easily damaged).
3. You are going to have to pad C21 on the bottom of the radio with a cap (some value between 20 - 60pF). Each radio is different. The Hygain V took 27pF.
4. With switch off, key mike on ch. 21, AM mode, and adjust frequency for ch. 21, 27.215 MHz, using CT-1 and CT-2.
5. Now throw switch. Frequency should go to 27.210. Some adjusting back and forth on CT1, CT2, CT3, CT4 will be needed. Be patient; it takes time.
6. If clarifier is unlocked it is a little easier; the spread is better.
7. Watch out to make sure you can tune in LSB on ch. 21.
8. The new 10-turn pot works great on the clarifier (available from Secret CB).
9. To unlock the clarifier, see Secret CB, Volume 3, on the Colt radios.

SUPERSCOPE AIRCOMMAND CB340

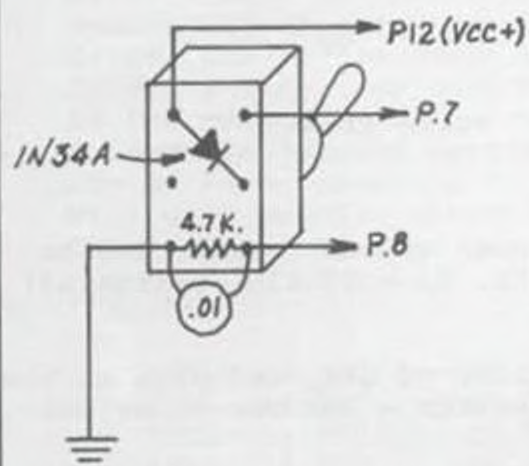

(1) LIFT 861 PLL CHIP OUT OF ITS SOCKET & LIFT PINS 14 & 24 OUT OF THE WAY.

(2) REINSERT THE CHIP INTO THE SOCKET & ATTACH 4.7 KΩ RESISTORS TO PINS 14 & 24 & CONNECT OTHER SIDES TO GROUND.

(3) WIRE DPDT TOGGLE SWITCH AS SHOWN.

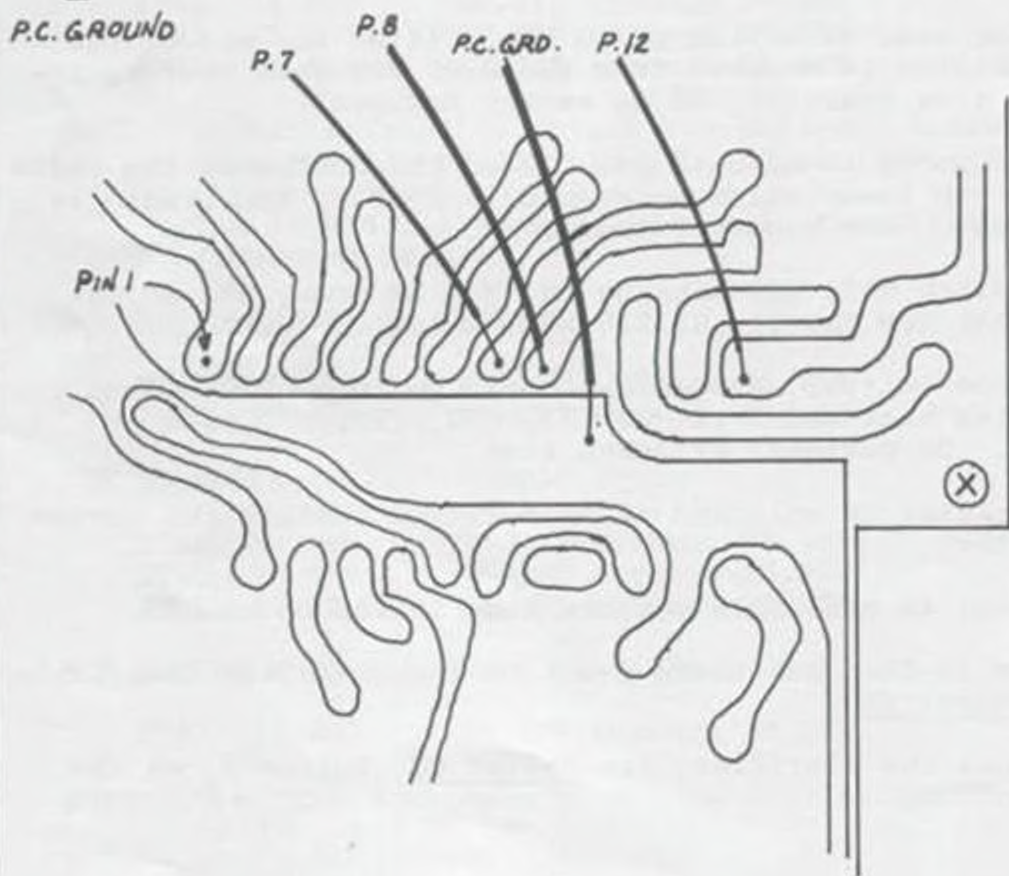

NOTE: VCO MUST BE ADJUSTED FOR FULL RANGE.

HYGAIN II 23 CHANNEL MODIFICATION

(Fits HYGAIN 681 (HYGAIN I, 1A), 682 (HYGAIN II, IIa))

USE CHANNEL SELECTOR 10020, GRINGSBY, INC., OR EQUIVALENT.

Remove J104.

Remove R112 and put on bottom of board for clearance purposes.

Put 1N47 diode on board where marked R192.

Remove R116 and put on bottom of board from anode of the 1N47 to collector of Q106.

Put 26K resistor from anode of 1N47 to 8.50 Volt source.

Put jumper from Pin 7 to gray wire on selector.

Put jumper from case of T101 to TP8.

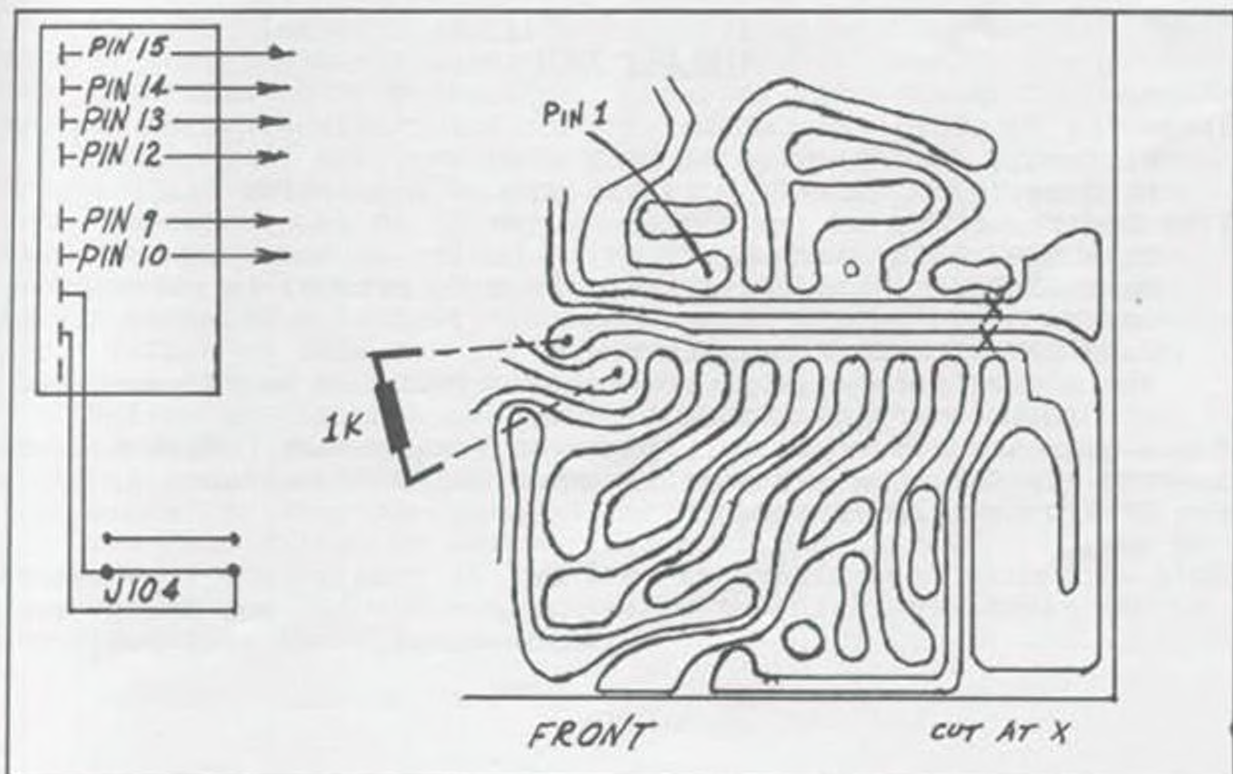

PALOMAR SSB-500 UPDATE

CPI CP300, 400 UPDATE

1. Palomar SSB-500 (MC145106 PLL) - additional information:
 - a. Ground Pin 6 (PLL chip) for divide by 5 through a switch.
 - b. +5-6VDC to Pin 6 (PLL) for divide by 10 through a switch.

NOTE: We suggest that you use one switch for this, such as a miniature SPDT center off toggle or DPDT center off.
2. CPI CP300, 400 (with 79 channel ROM installed), for channels 80-99 - sequence starts on channel 30:
 - a. Ground Pin 3 of ICJ through a switch. This will give you 80-99 starting on channel 30.
 - . NOTE: This will work on the CP2000 base with the original PLL! VCO must be retuned.
 - b. For #10KHz jump - to get RC channels (300 & 400)
 1. Through a switch ground Pin 4 of ICG.
 2. This function must be combined with -5 KHz drop (+5V to TP10) by putting on a SPDT center off miniature toggle switch in hole below 10's selector switch (mobiles only (300 & 400)).
 - c. For low frequencies on CPI's.
 1. Run +5 volts through a switch to Pin 4 of ICJ
 2. Make sure VCO is retuned so that these frequencies will fire.
 3. It is doubtful that the VCO will cover both high and low frequencies at once. Changing the two VCO capacitors to 300pF each will help.

MIDLAND 7001

Change the 10.46670 crystal to:

Hi freq.: Ch. 41-85 - 10.6916 xtal.

Lo freq.: Ch. 26.955 - 26.515 change to 10.2416 xtal.

Slide Modification:

Clip D49, R148, jump D50

Install Super Diode (available from Secret CB) in place of D4.

Jump C27 with 22pF capacitor.

Run a wire from unused terminal on clarifier to 9V source - Emitter of Q36.

If you unground Pin 9 you will get even frequencies. With a 10.46670 crystal, the set goes low when Pin 9 is ungrounded, from 26.510 to 26.950.

BROWNING MARK IVA

MODIFICATION & UFO INSTALLATION

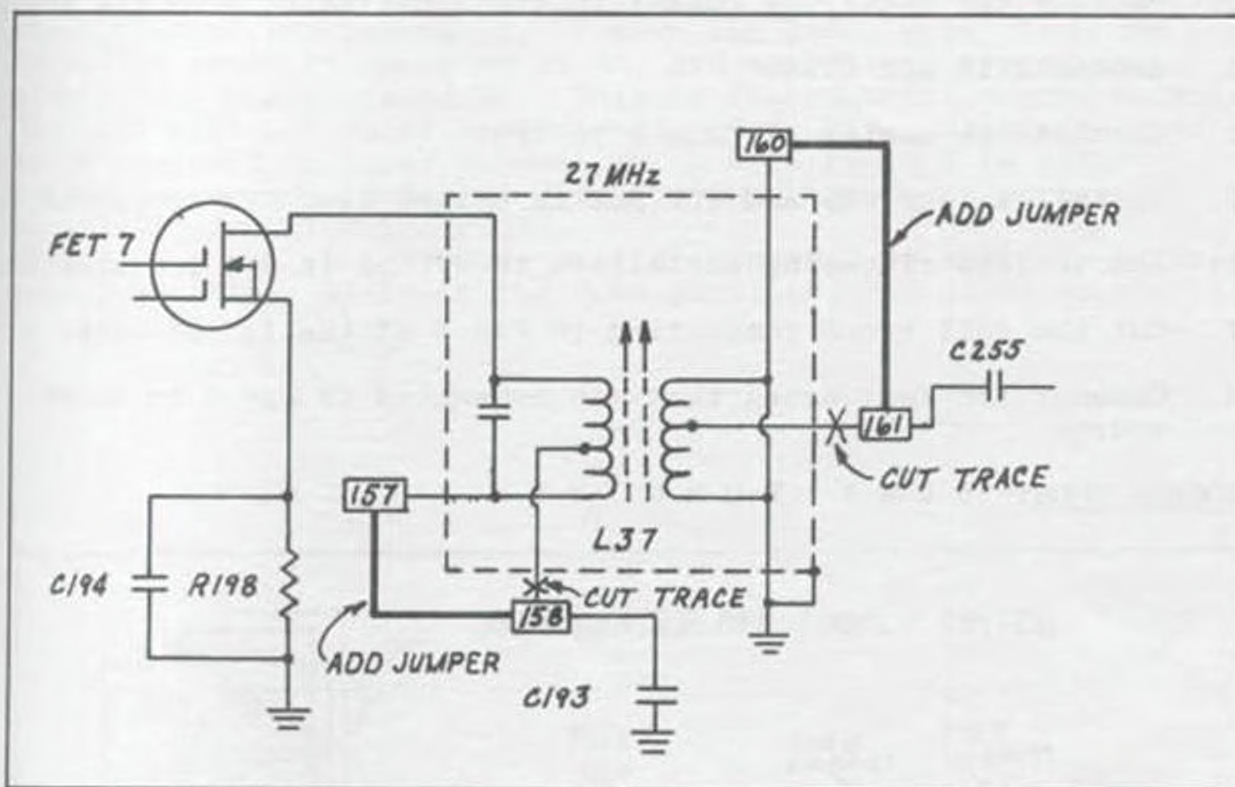

LOOP FILTERING

The addition of a variable loop filter on 8719 and 8734 radios is occasionally a necessity. A variable loop filter allows the technician to vary the loop filtering and make up for variables present in synthesizer circuits of radios.

Symptoms of the loop filtering being incorrect may be: distorted SSB, warble on SSB, difficult to clarify SSB, or, in extreme cases, squeal on AM and bleedover may be present. In most cases the problems described above are most easily cured by the addition of a variable loop filter consisting of a variable resistor (usually a trimpot) in series with an electrolytic capacitor. Values of 10uF and 10k have been used quite successfully. This loop filter is added between TP9 and ground.

Better results can be achieved by removing the capacitors inside the UFO which normally compose the loop filter. These capacitors are identified in the programming section of the instruction manual as they are removed for 858 installations.

The loop filter is aligned for best SSB clarity. If the resistance of the trimpot is too low, the radio will warble on higher frequencies and, if the resistance is too high, bleedover may be experienced on lower frequencies.

BROWNING MARK IVA CONTINUED:

1. Do not remove 145106 PLL chip.
2. Connect the center of Coax 1 to the Junction of R708 and R709.
3. Remove R715 and C734.
4. Connect the center of Coax 2 to TP3.
5. Install a 10uF cap and 10k pot in series from TP3 to ground.
6. Remove loop filtering capacitors in UFO as in 858 installation.
7. Cut the foil trace connecting to Pin 8 of the 145106 chip.
8. Connect the foil trace that was connected to Pin 8 to an 8V source.

PROGRAM CODE: B B W W B B B B W W

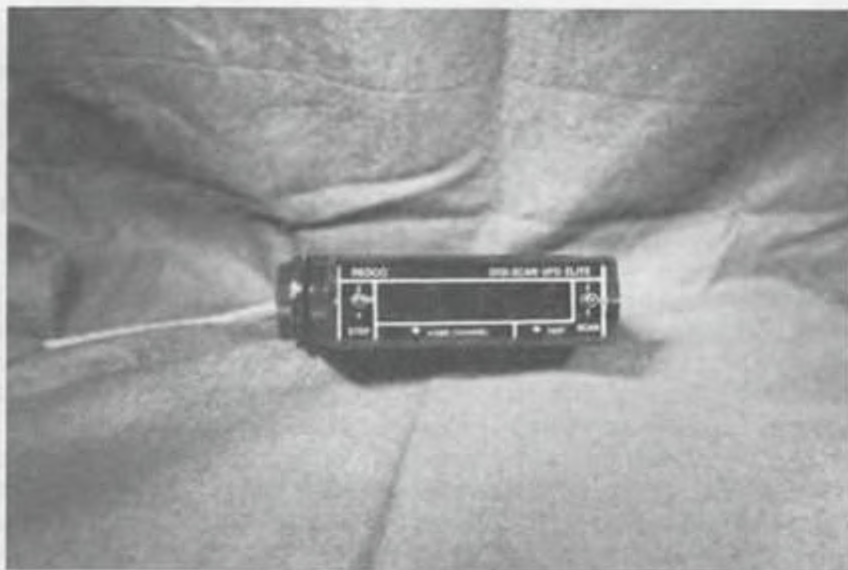

FREQUENCY MODIFICATION FOR JC PENNYS 6248 SSB

SLIDE: Remove R303 to disable transmit voltage. Follow the black wire from clarifier control and lift at the point where it meets the P/C board and ground it. Remove the green wire from the clarifier where it meets point RD, and move it to the opposite side of the board marked BB. This is the constant source voltage. The unit will now slide on transmit. Both varactor diodes need to be replaced by super diodes, which will yield 7 to 11KHz. If you use chokes in series with the super diodes, you may not be able to recenter the radio.

EXPANSION: The switch shown will give normal 40 channels in the center position, 44-59 in the down position, and 60-99 in the up position.

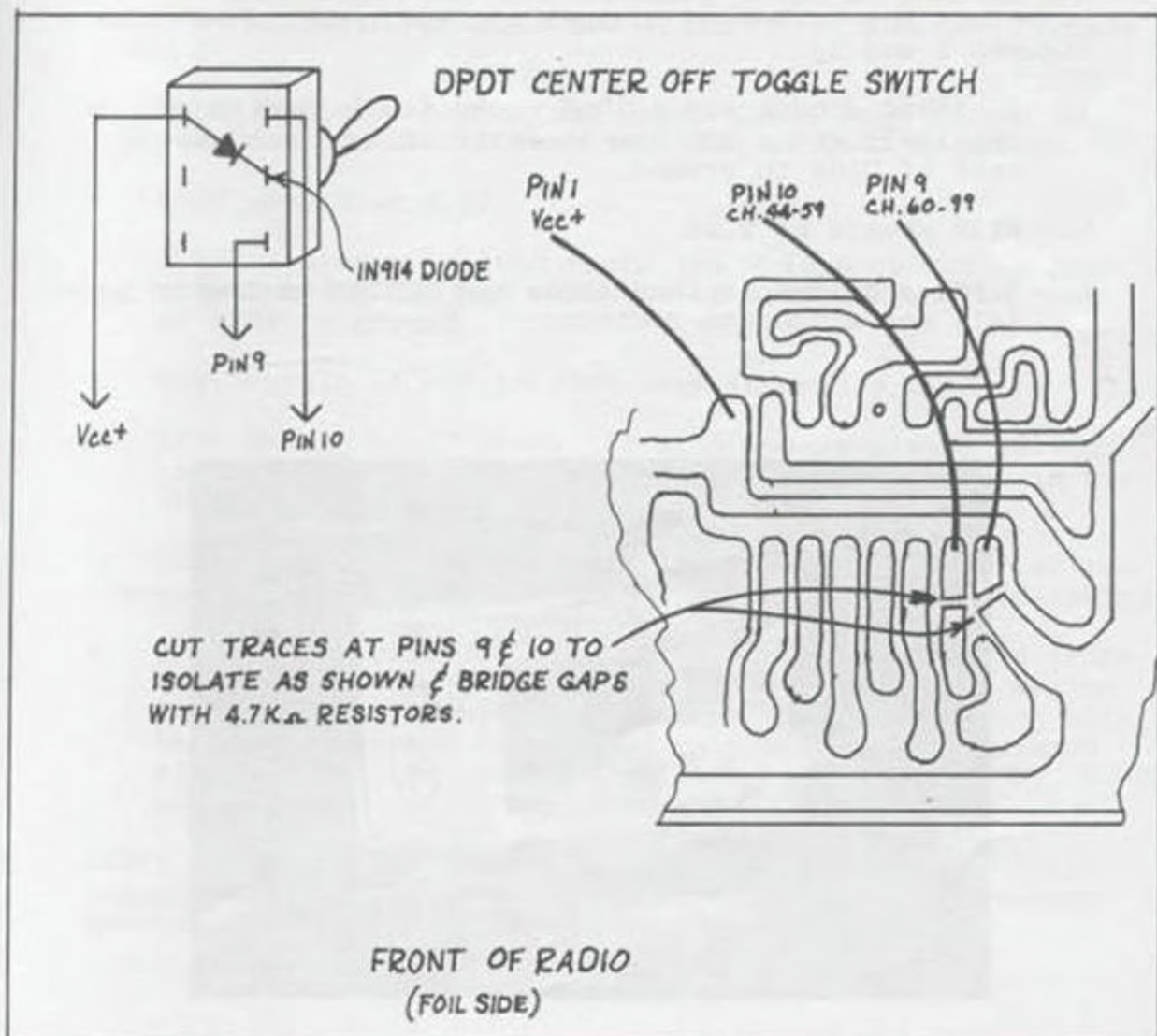

BROWNING MARK IV TRANSMITTER

TROUBLESHOOTING

SYMPTOM:

The Channel Number display is blank and the transmit relay will not key. The reset "low limit" LED comes on but there is no channel display.

POSSIBLE SOLUTIONS:

1. In the synthesizer circuit (PLL section) C121 should be 10pF N750 and C123, 39pF N750. The early 23 channel models employed NPO's. Also R101 and R102 should be changed to 330 ohms, and a 1 megohm resistor should be added from the base of Q101 to ground.
2. The changes noted in paragraph 1 have been incorporated in the 40 channel units. All units should be checked to insure that the following changes are included. (Refer to Figures 1 and 2)
 - a. 3, 1N914 diodes and a 10uH choke (or 2 18uH chokes in parallel) and a 220 ohm resistor in series from the base of Q104 to ground.
 - b. R129 should be 2.2K
 - c. 3 1N914 diodes, a 10uH choke (or 2 18uH chokes in parallel) and a 220 ohm resistor



BROWNING MARK IV TRANSMITTER

SERVICE HINTS

SYMPTOM:

The Channel Number display is blank and the transmit relay will not key. The reset "low limit" LED comes on but there is no channel display.

POSSIBLE SOLUTIONS:

1. In the synthesizer circuit (PLL section) C121 should be 10pF N750 and C123 39pF N750. The early 23 channel models employed NPO's. Also R101 and R102 should be changed to 330 ohms, and a 1 megohm resistor should be added from the base of Q101 to ground.
2. The changes noted in paragraph 1 have been incorporated in 40 channel units. All units should be checked to insure that the following changes are included. (Refer to Figures 1 and 2)
 - a. 3 1N914 diodes and a 10uH choke (or 2 18uH chokes in parallel) in series from the base of Q103 to ground.
 - b. R129 should be 2.2K
 - c. 3 1N914 diodes, a 10uH choke (or 2 18uH chokes in parallel) and a 220 ohm resistor in series from the base of Q104 to ground.
 - d. R127 should be 680 to 1000 ohms (normally 1K)
 - e. R131 should be 47 ohms. If a 100 ohm resistor exists, it is acceptable to add another 100 ohm resistor in parallel on the bottom side of the circuit board.
3. In those units where the symptom is still present after the foregoing changes have been made, proceed with the following:
 - a. The color stripes on Q102, Q103 and Q104, MPS6514 transistors should be checked. If the 2nd or middle stripe is yellow, it should be replaced. The transistors with the yellow stripe have lower gain and can be employed elsewhere in the unit, but cannot be used for Q102, Q103, or Q104.
4. After the unit has been checked to insure that all of the changes have been incorporated, the following measurement should be made:

BROWNING MARK IV TRANSMITTER SERVICE HINTS (CONT'D)

NOTE: AN OSCILLOSCOPE WITH A BANDWIDTH OF AT LEAST 25 MHz MUST BE USED OR THE P.P. READINGS WILL NOT BE ACCURATE.

The RF voltage on the emitter of Q104 should be between 2-3 volts P.P. (preferably closer to 3V.) If this measurement indicates a reading of less than 2 volts check the modifications again to insure that all changes are correct or that the transistors involved are not of the low gain type. Should the reading be above 3 volts select a value of R127 between 680 and 1000 ohms to obtain the desired reading. If the reading is above 3 volts when a 680 ohm resistor is used, add a 10pF NPO from the base to the collector of Q103.

5. The foregoing changes in part, or in their entirety, should restore the functioning of the channel number display. In rare instances the symptom may still exist and in those cases the circuits involved should be checked for heat sensitive components - particularly IC105 - 108. Further, the Mark IV service manual should be used for further trouble shooting information.

THIS SPACE FOR YOUR NOTES;

CORRECTION FOR VOLUME 5, Page 28:

Remove D304 (not D309) and D306 (not D310), and install Super Diode.

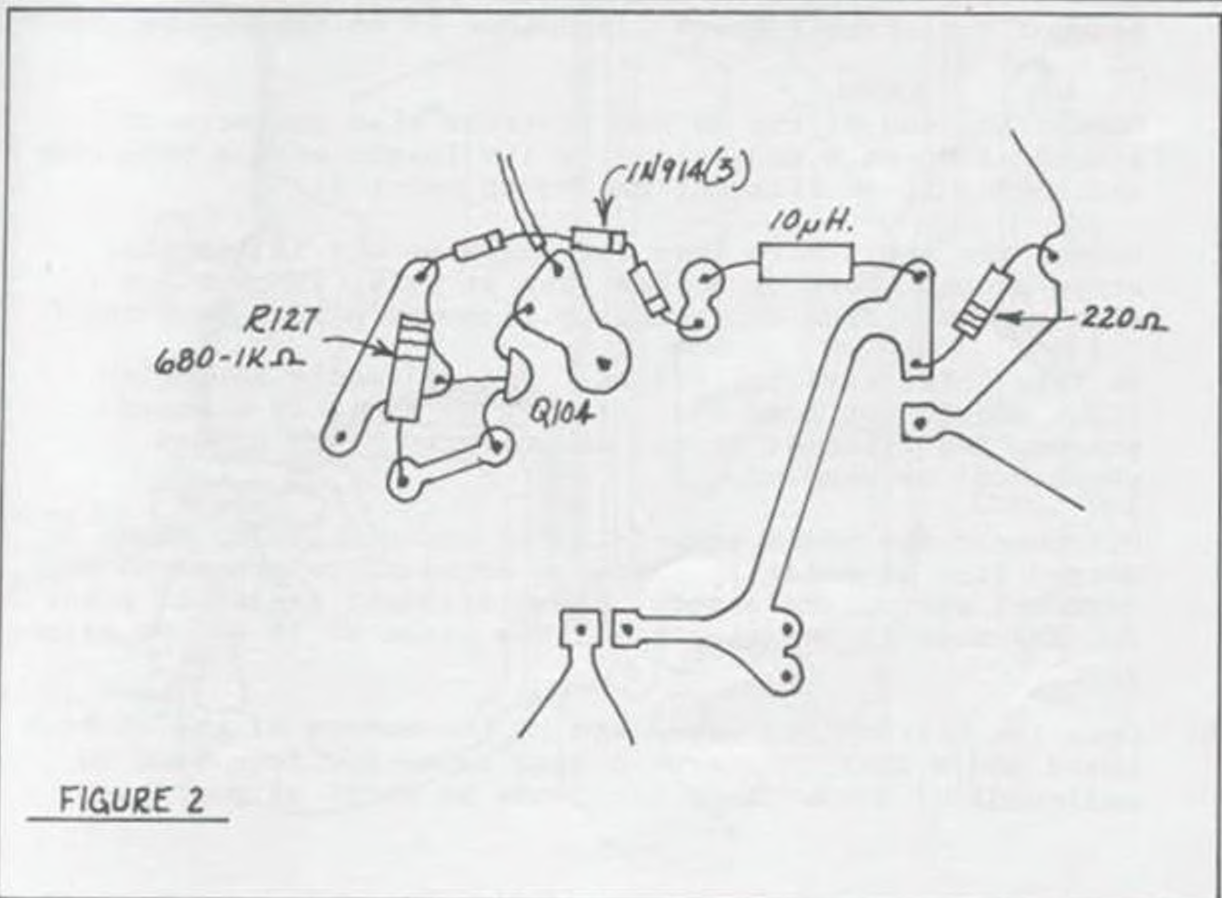
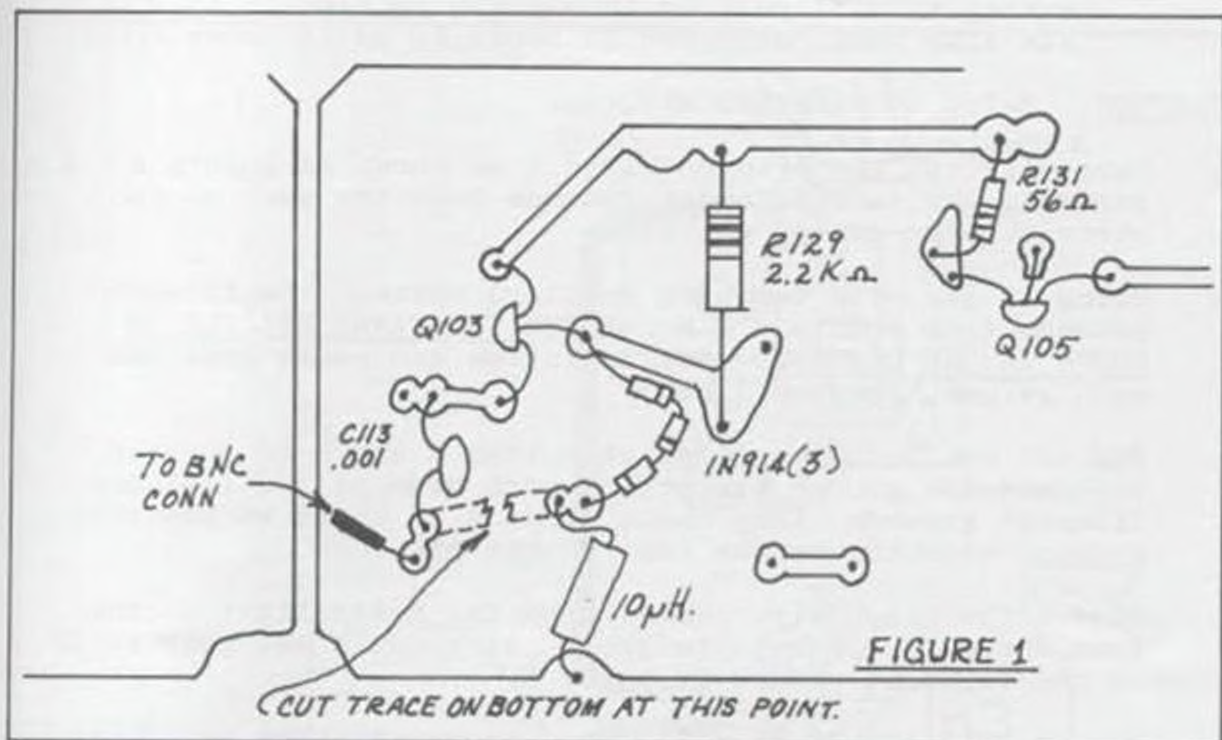

BROWNING MARK IV TRANSMITTER SERVICE HINTS (CONT'D)

SYMPTOM: Garbled transmit on SSB - especially the upper channels, making it difficult or impossible to clarify it. It has also been described as sounding as if under water.

SOLUTION: Refer to attached diagram.

1. Carefully cut the printed circuit as shown at points A - H - removing the tube filament grounds from the rest of the circuit board ground pattern.
2. Using 18 ga. wire (nothing smaller) connect the filament grounds from points A - H. ROUTE THE WIRES EXACTLY AS SHOWN IN THE DIAGRAM! Any deviation can cause problems such as hum, feedback, etc.
3. Add two small jumper wires at points G and H to connect together the ground pattern on each side of the isolated filament grounds. Keep these jumpers as short as possible without shorting to the tube socket pins.
4. Remove the black wire coming from the meter light socket from where it connects to ground at point K and connect it to the filament ground at point E.
5. Remove C212 (68pF) from its present position on the top side of the circuit board and solder it on the bottom side at point L.
6. Remove the end of the 10 ohm resistor that connects to ground at point M and extending its length with a buss wire and solder it to filament ground at point A.
7. Remove the short wire from the relay socket to terminal strip ground shown by dotted line at point I. Connect a wire as shown from the relay to filament ground at point C.
8. At this point turn the set on. The filaments and meter light should not come on. If they do there is a short between the filament ground and circuit board ground which must be removed.
9. Disconnect the black wire from the control cable, shown by dotted line at point J, where it connects to ground on a terminal strip, and connect it to filament ground at point B. You may have to lengthen it with a piece of 18 ga. or larger wire.
10. Open the synthesizer cover and on the bottom of the circuit board add a 10pF NPO ceramic disc capacitor from base to collector of Q103. Keep the leads as short as possible.

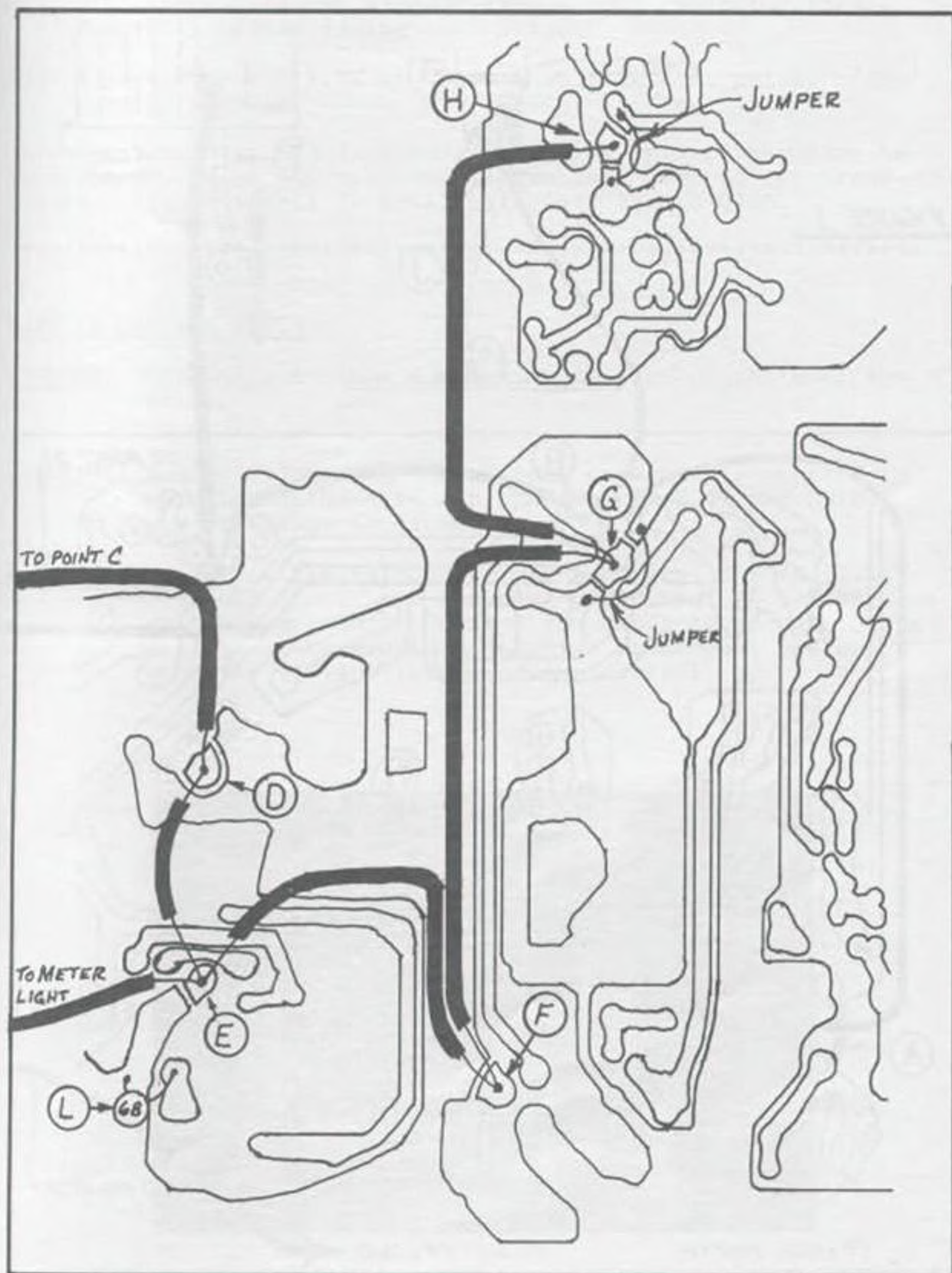
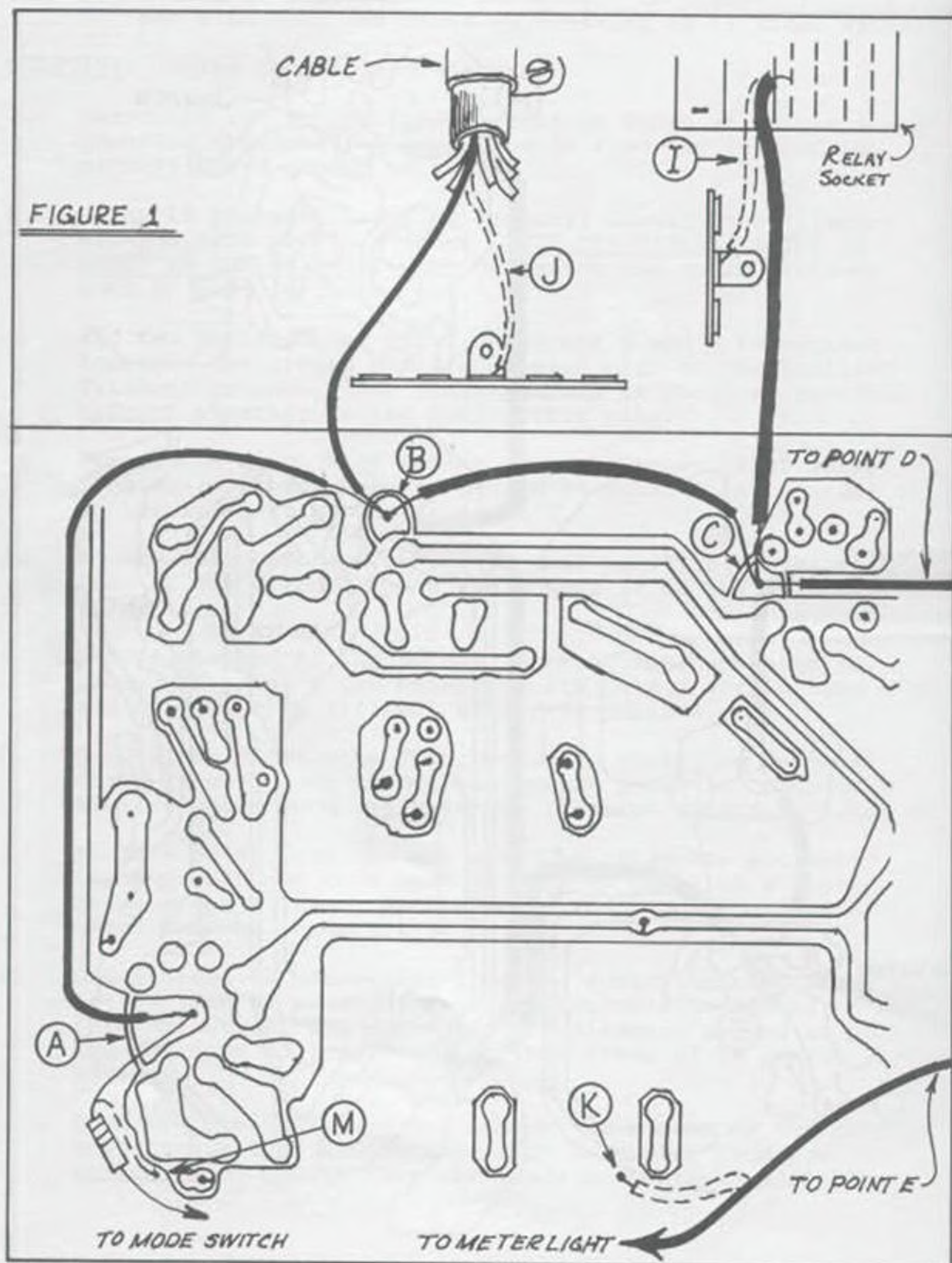

FIGURE 1



BROWNING MARK IV TRANSMITTER SERVICE HINTS (CONT'D)

11. Add a .001 ceramic disc capacitor from base to ground of Q101 (some sets may already have a .002 capacitor there. Remove it before adding the .001).
12. Adjust C122 for 1.8V at control voltage test point. (See service manual).

This completes the modification. In a few sets it may also be necessary to place the receiver on the left side of the transmitter. If the signal is still not clear change Q105.

MARK IV SERVICE HINTS

SYMPTOM: Excessive arcing of the high voltage contacts of the relay.

SOLUTION: Remove CD601, a 1N4005 diode, presently connected with its cathode to the junction of R317 and R319, and its anode to ground.

Reconnect the cathode to the junction of R316 (1.5K, 5W), and the orange and pink wires that go to the mode switch and relay. Connect the anode to ground. This will shunt to ground a negative pulse that can exceed the voltage rating of the contact.

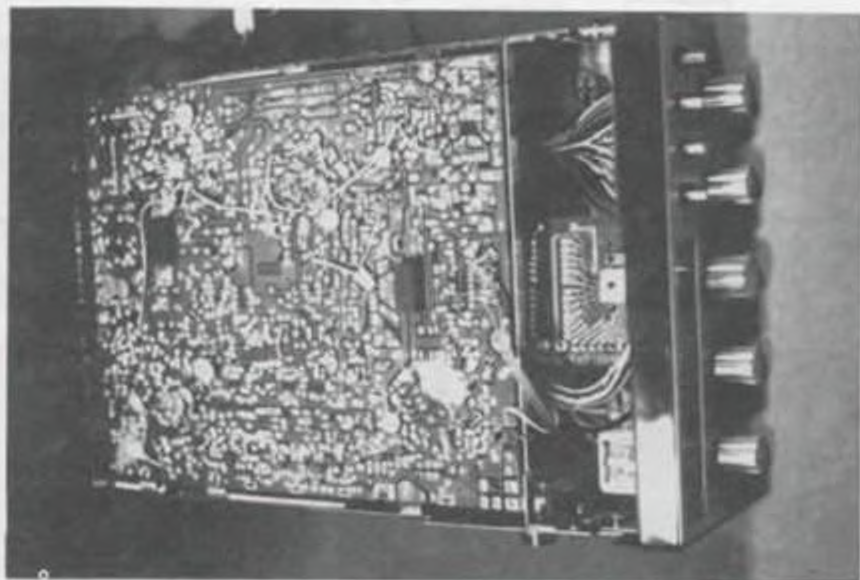

DUAL RANGE SLIDER FOR PRESIDENT WASHINGTON (NEW)

NOTE: WILL ALSO WORK ON OTHER RADIOS WITH SIMILAR CHASSIS,

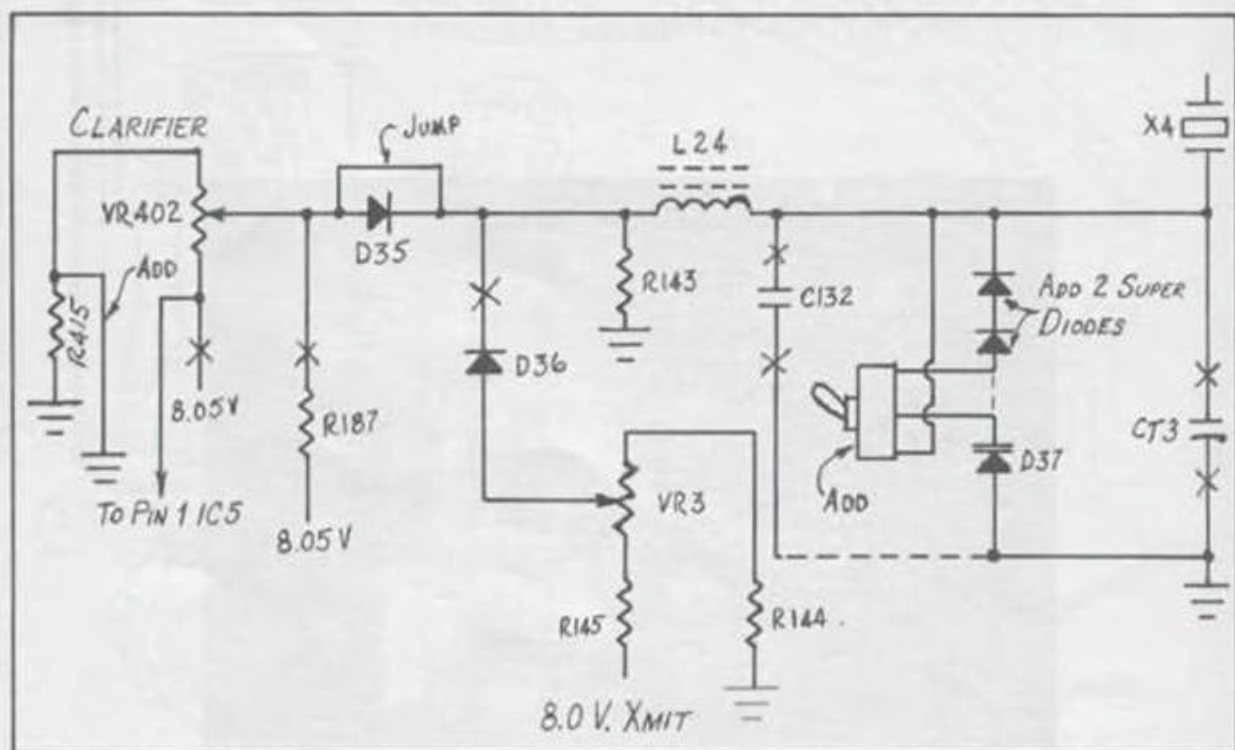

DUAL RANGE SLIDER FOR PRESIDENT WASHINGTON (NEW) (CONT'D)

The slide will operate as follows:

Position A:

Slide 10KHz: +4 -6

Center slot is same as channel indicated by radio's LED indicator.

Position B:

Slide 50KHz: +20 -30

Center slot is 20KHz below channel indicated by radio's LED indicator.

A 20K, 10 turn clarifier pot (available from Secret CB) was installed in place of VR402, as 50KHz is impractical on the stock pot. Also available from Secret CB are the Super Diodes and Super Slide components shown above.

SLIDE MODIFICATION FOR PRESIDENT GRANT (NEW)

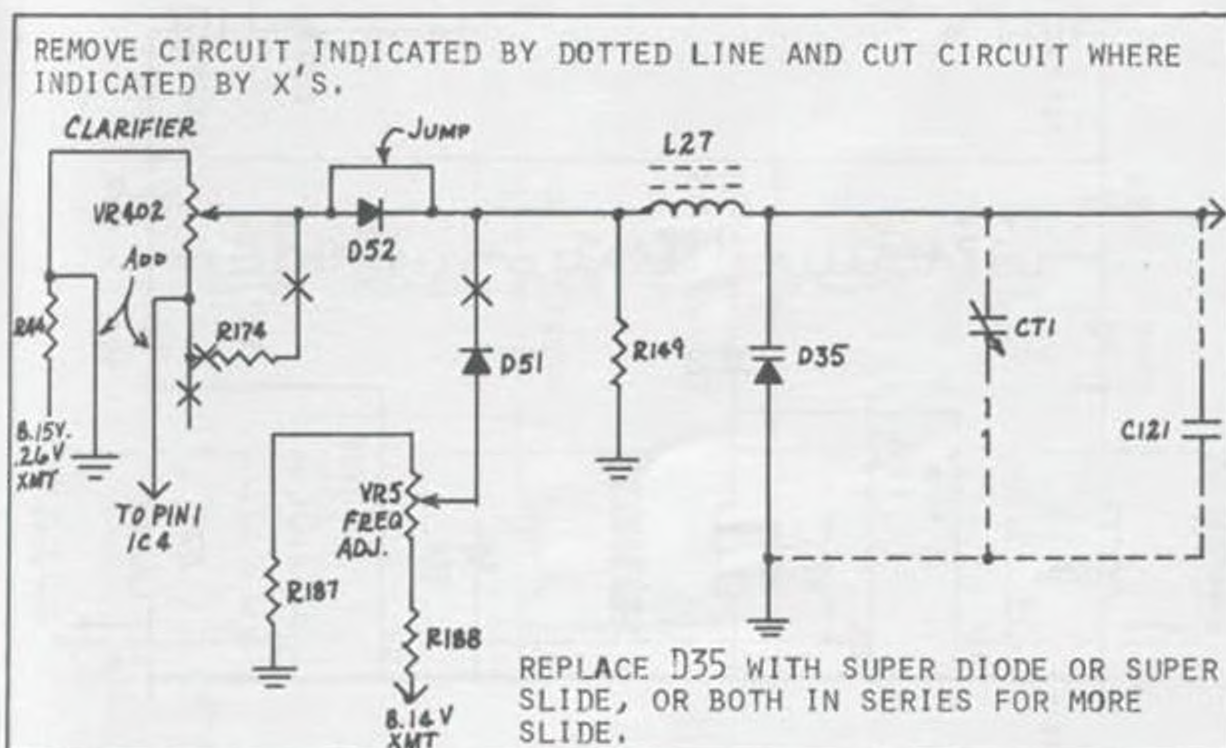

HOW TO MAKE YOUR COBRA 142GTL CLARIFIER SLIDE

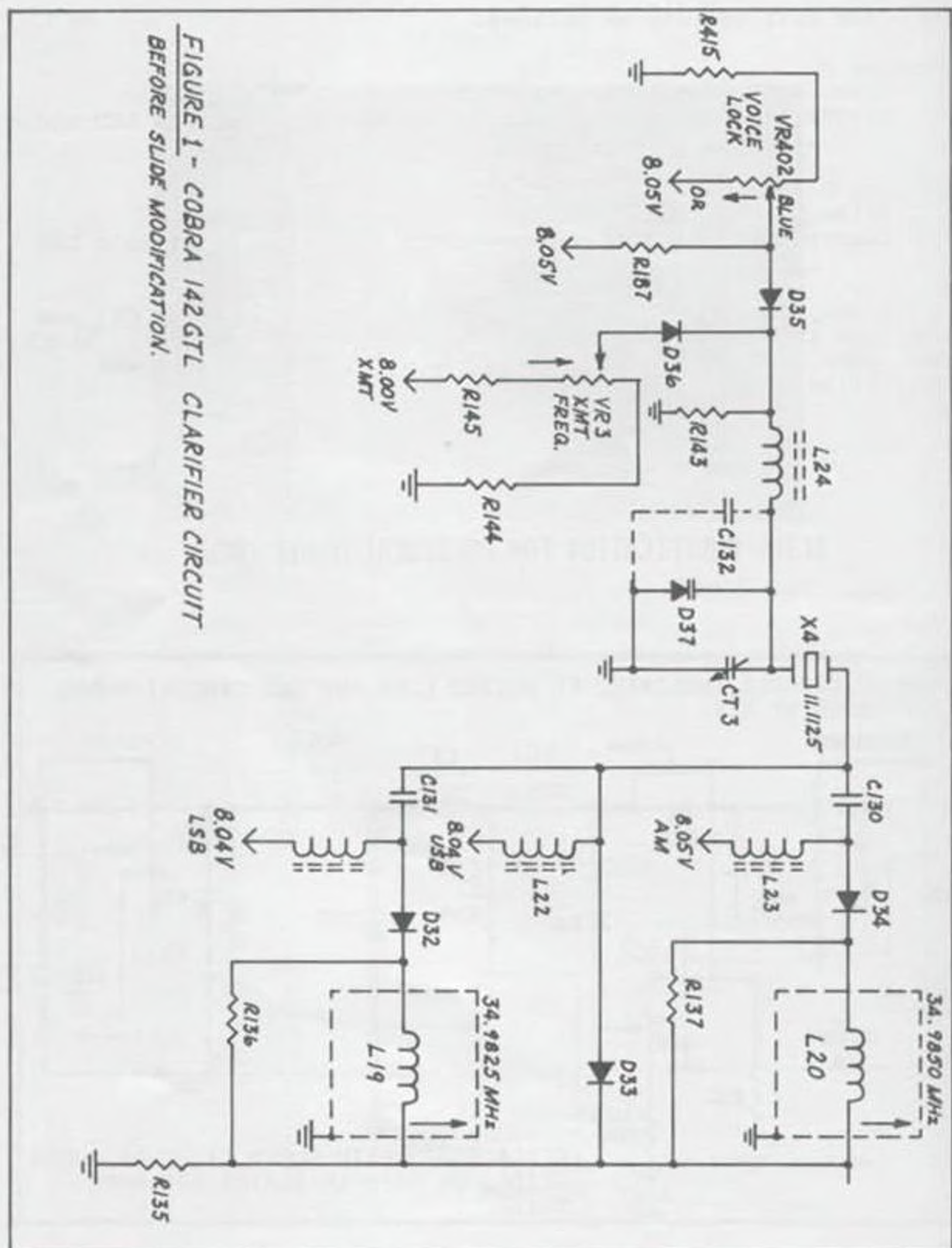
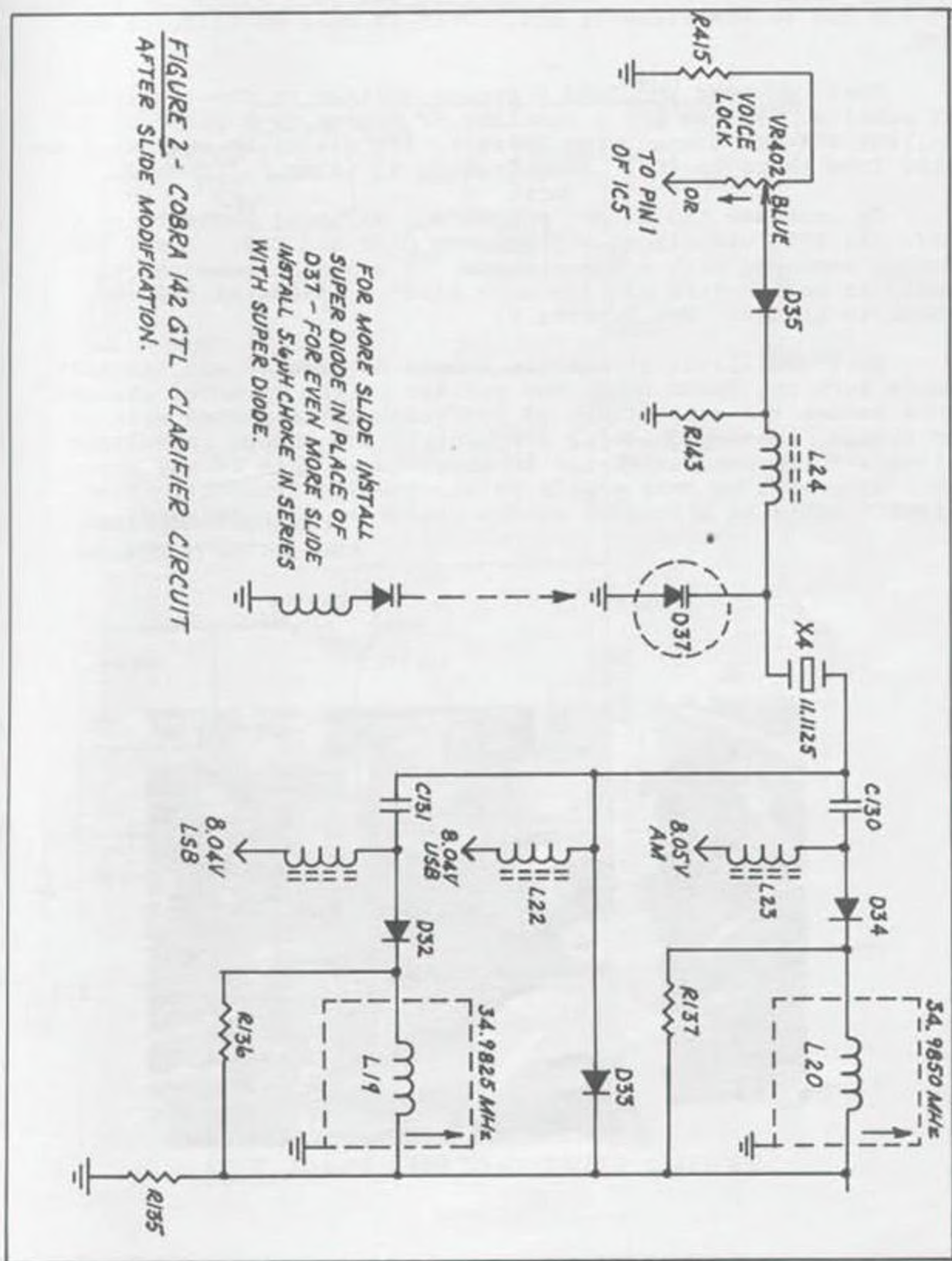

FIGURE 1 - COBRA 142GTL CLARIFIER CIRCUIT BEFORE SLIDE MODIFICATION.

COBRA 142GTL CLARIFIER SLIDE (CONT'D)



HOW TO MAKE YOUR COBRA 142GTL CLARIFIER SLIDE

Our first objective is to eliminate the transmit control voltage which is fed through VR3 (the transmit frequency adjust) to D36 and to the varactor D37. This is done by clipping out D36.

Next, we need to feed a steady voltage to the clarifier at point A. We can get a constant 8V source from pin 1 of IC5. So, cut off the orange wire going to the clarifier and run a new wire from there to IC5. (See Drawing 2) Also, clip R187.

To increase the slide, remove any parallel capacitance to D37. In this circuit we will remove C132 and CT3. Also, D37 can be replaced with a super diode, or a 5.6uH choke can be added in series with D37 for more slide. (Anode of D37 to choke to ground: See Drawing 2)

This oscillator circuit is common to receive and transmit. As we turn the VOICE LOCK, the voltage to the varactor changes. This causes the capacitance of D37 which is in series with X4 to change, thereby shifting frequency. Any change in voltage gives a corresponding change in frequency. This is why our 8V source must be very stable on receive and transmit. This circuit works in a tripler so the change is also tripled.

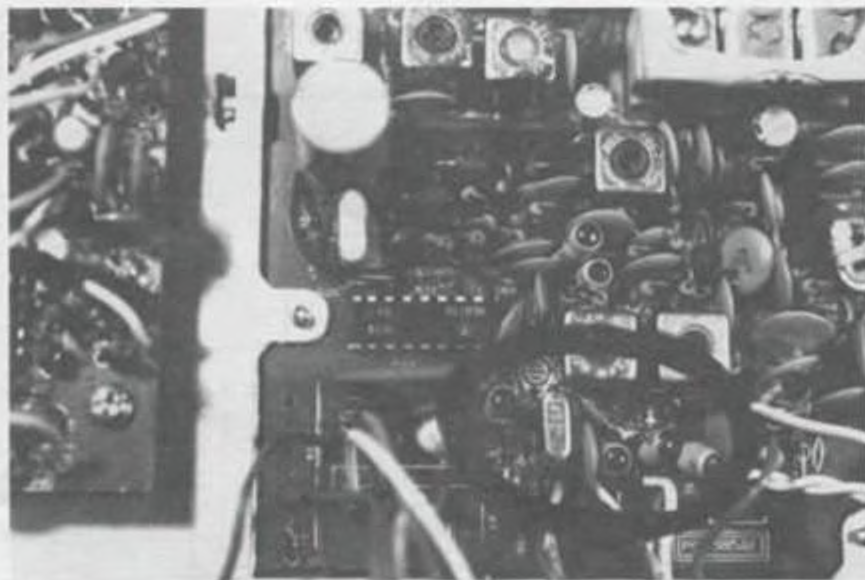

COBRA 135XLR CLARIFIER UPDATE

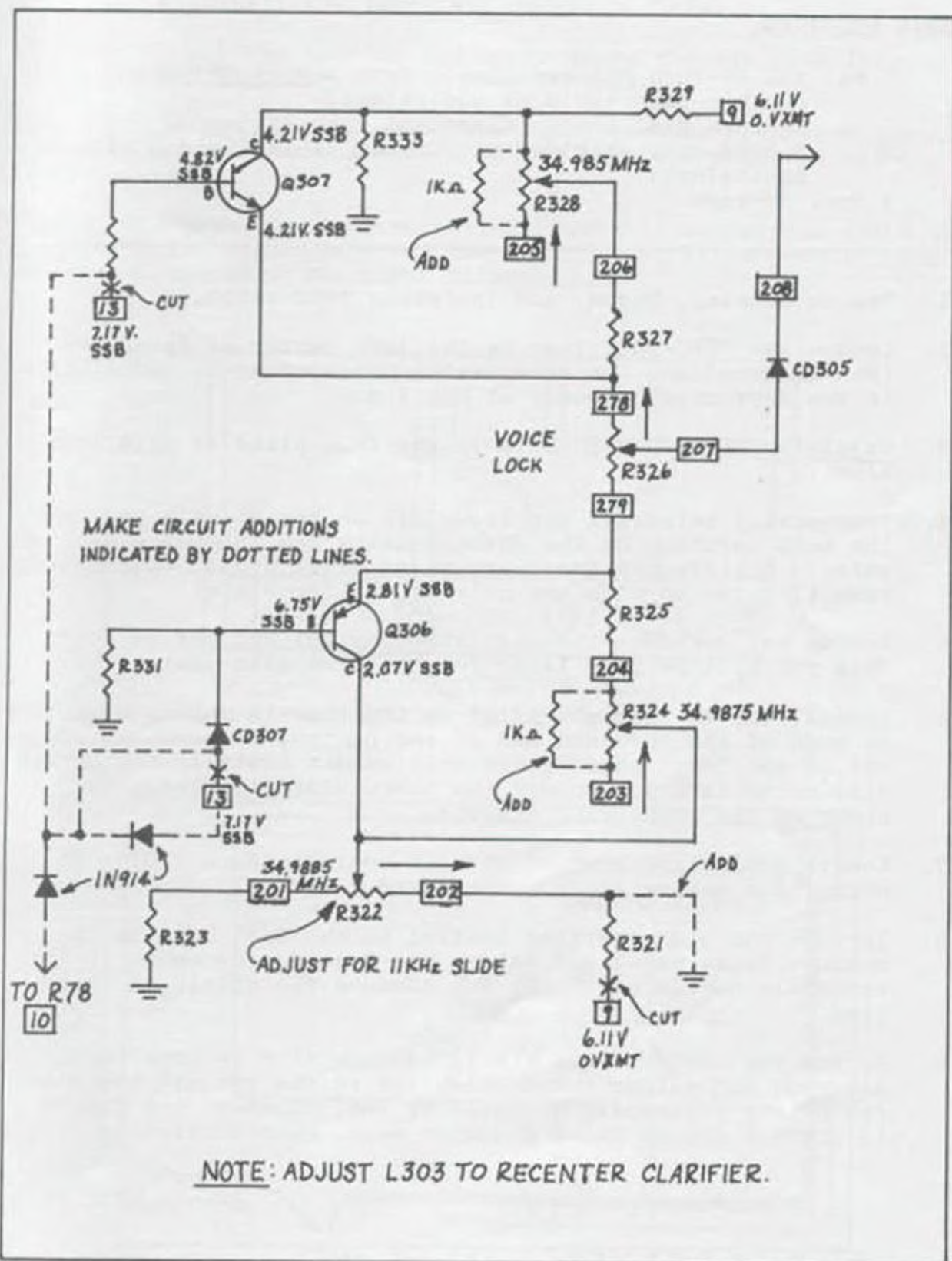

MIKE GAIN CONTROL & 10-TURN "FINE-TUNING" CLARIFIER
FOR REALISTIC TRC-458

PARTS REQUIRED:

- 1 ea. 20K 10-turn pot (available from Secret CB)
(Bunker-Ramo 4201B or equivalent)
 - 1 ea. 10-turn dial scale (Clarodial type 411)
 - 18" 3-conductor shielded microphone cable (Belden 8735 or
equivalent)
 - 1/2 doz. Ty-raps
-

1. Remove housing, knobs, and faceplate from radio.
2. Locate the "TRC-458" logo on the left center of faceplate (See diagram) and, using a center punch, make an indentation in the approximate center of the logo.
3. Carefully drill a 1/8" hole in the face plate at this location.
4. Temporarily reinstall the faceplate on the chassis and mark the hole location on the chassis using the faceplate as a guide. Centerpunch the chassis and drill a 3/8" hole making sure it lines up with the hole in the faceplate.
5. Remove and desolder the clarifier control and set it aside. This pot will be used later for the mike gain control.
6. Install the 10-turn clarifier in the chassis making sure that as much of the threaded end of the control as possible extends out of the front panel (this will permit installation of the dial scale later). Solder the three clarifier leads as shown in the connecting diagram.
7. Locate VR6 (right rear of circuit board) and carefully desolder and remove it from the board.
8. Install the old clarifier control in the 3/8" hole in the chassis front panel and solder the 3-conductor cable to the terminals on the pot. (Do not connect the shield at this time.)
9. Secure the cable to the wiring harness with ty-raps (see diagram) and solder the 3-conductor to the circuit board at the points previously occupied by VR6. Connect the shield to chassis ground using a jumper wire. (see connecting diag.)

REALISTIC TRC-458 CONVERSION (Cont'd.)

10. Carefully enlarge the 1/8" hole in the face plate to 3/8" and reinstall the faceplate on the chassis.
11. Reinstall the housing and knobs using the old clarifier control knob on the mike gain control.
12. Rotate the 10-turn clarifier fully counter clockwise and install the dial scale knob making sure the scale is set to zero (0).

NOTE: The mike gain control allows variable audio gain (like the Cobra "Dynamike") and the 10-turn clarifier permits very fine tuning for super DXing.

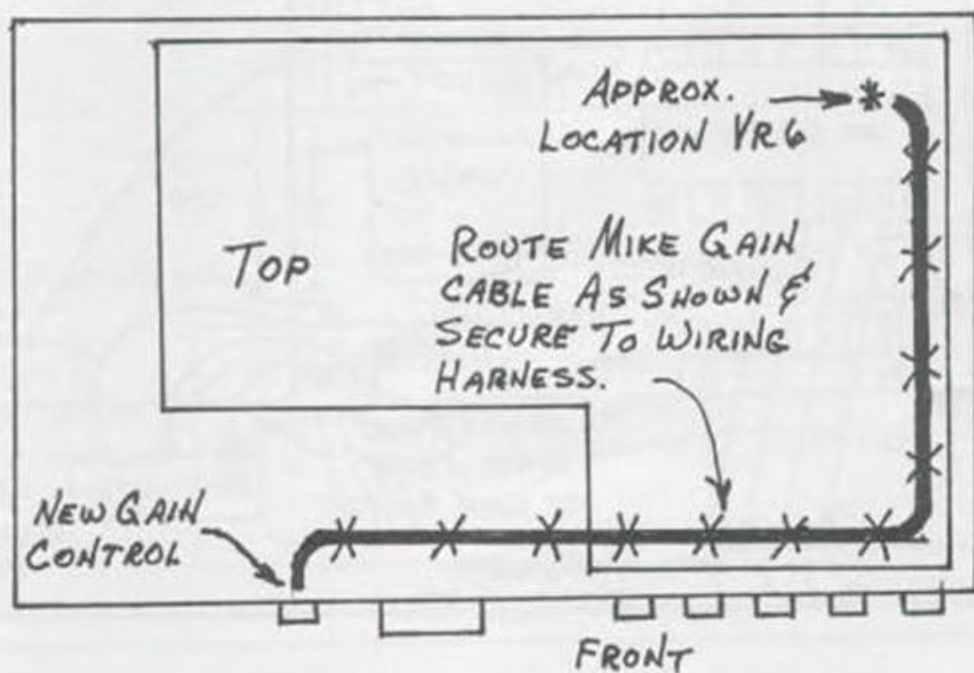
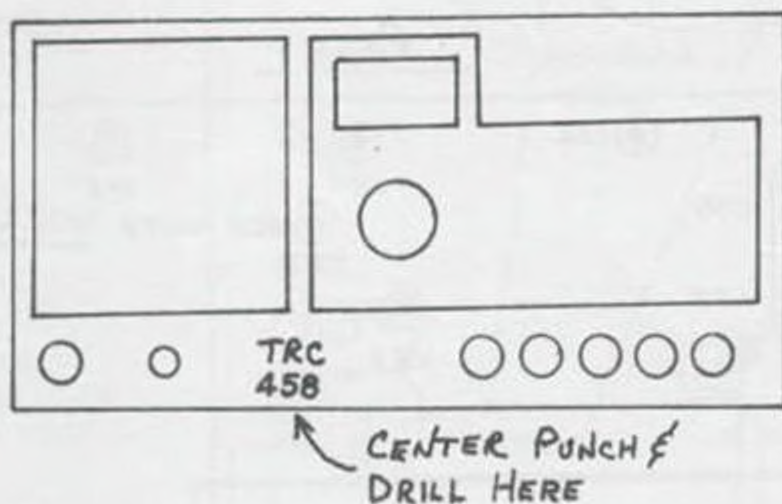

OOPS! WE GOOFED!

OMITTED DRAWING FOR PALOMAR SSB500

VOLUME 5, PAGES 31-34

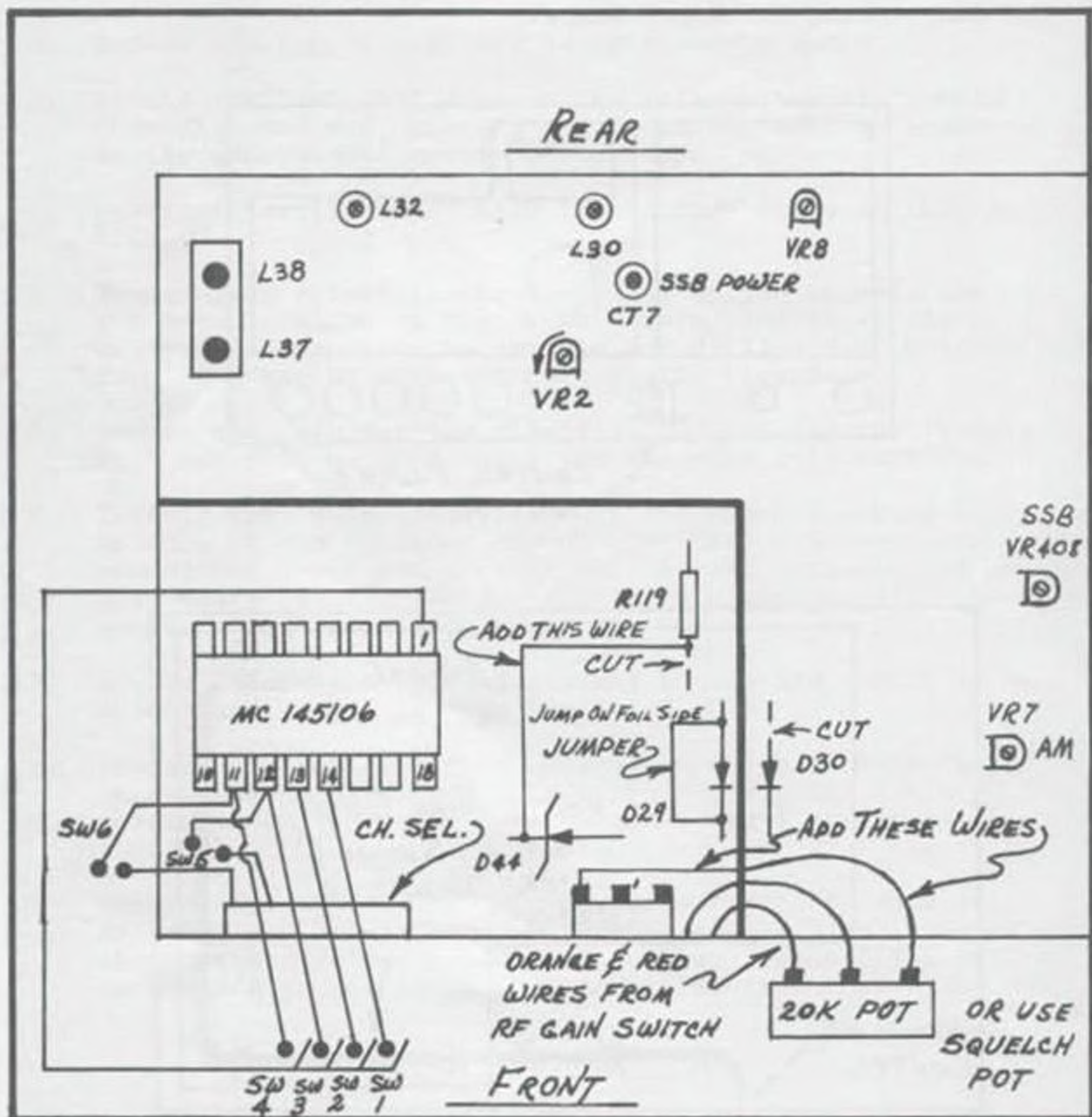

OOPS! WE GOOFED!

CORRECTED DRAWING FOR SBE LCBS-4
VOLUME 7, PAGE 31

FIGURE B.

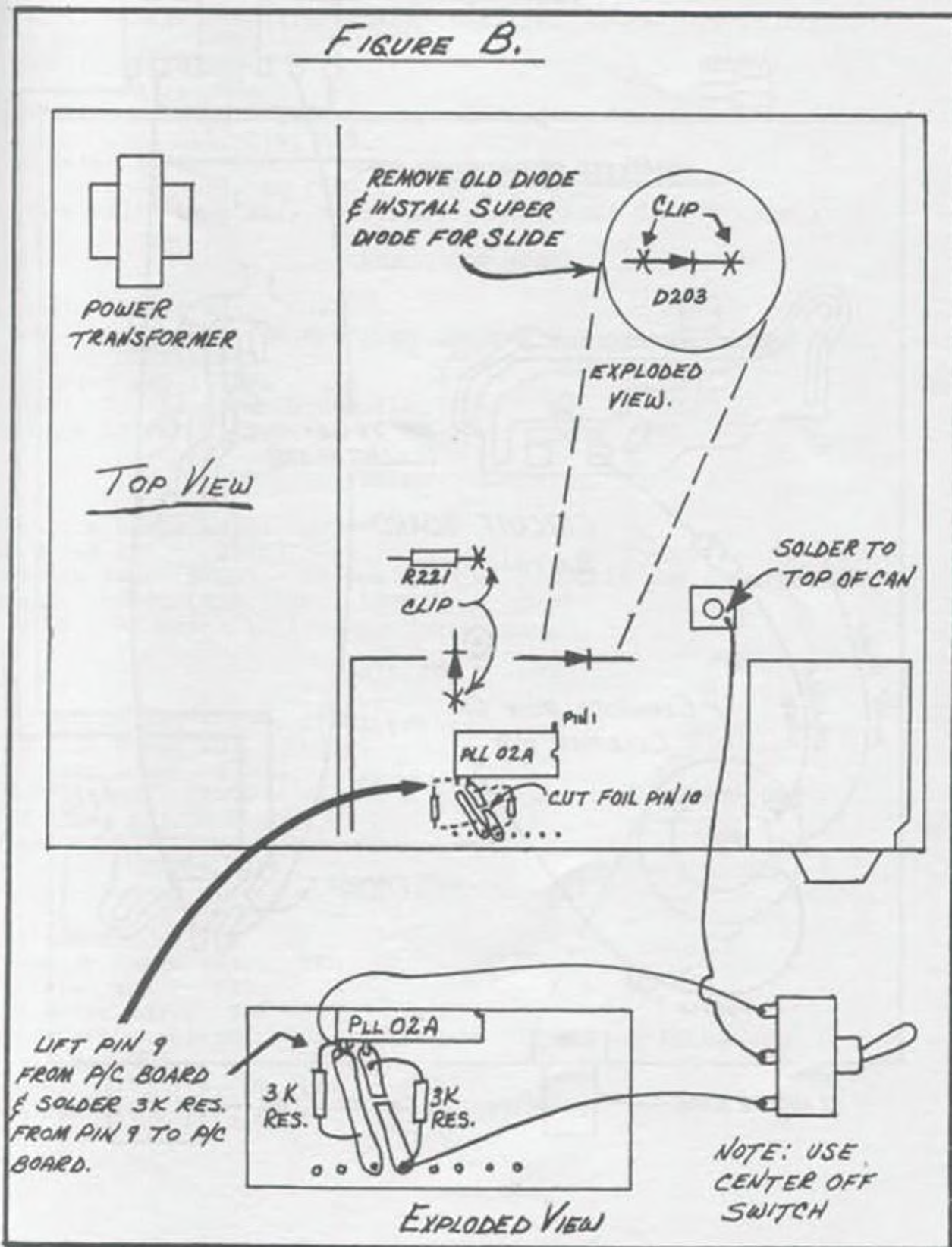

OOPS! WE GOOFED
SBE LCMS-4

Correction from Volume 7, page 37.

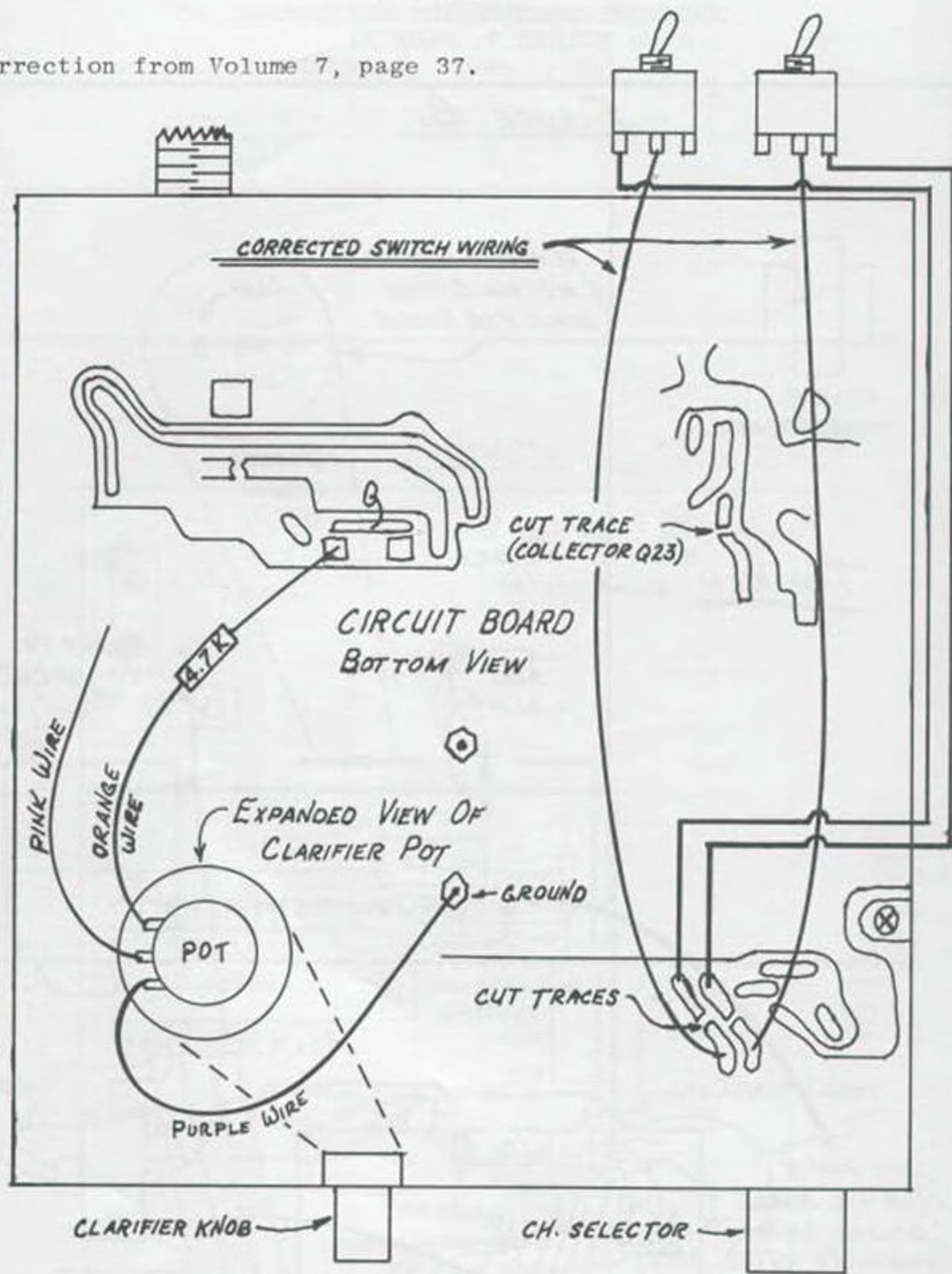

SPECIFIC RADIO TUNE-UPS

COBRA 78X

First, change insulator (mica-thin type TO-220) on RF final.
IF Gain adj.: VR7
Squelch range adj.: VR3
S Meter Adj.: VR4
Modulation: VR6 - defeat, pop one leg of C49.
Peak: L10, L11, L12, L15
RF Meter Adj.: VR5
Do not touch L18, as this is the TVI trap.
(This radio is highly modifyable; some will do 12W easy.)

KRACO KCB 4030

Squelch range adj.: RV1
Modulation: RV2; if won't go up, pop Q15 out of PC board.
S Meter adj.: RV3
RF Meter adj.: RV4
Peak: T3, T4 (Some production runs: L7, 11, 12)
Do not touch L9; TVI trap.

MIDLAND 77-101B

Squelch Range adj.: RV101
S Meter adj.: RV103
Modulation: RV201 - if won't go up pop C228 out of circuit.
Peak: L303, L304, L305, L306
RV202: RF Meter adj.

MIDLAND 77-824

NOTE: Do not adjust RV301 (AWI)
Squelch Range adj.: RV101
S Meter adj.: RV103
Modulation: RV201 - if won't go up, pop one leg of C228
RF Meter adj.: RV202
Peak: L303, L304, L305, L306

REALISTIC TRC-421

IF AGC adj.: VR1
Squelch Range adj.: VR2
S Meter adj.: VR5
RF Meter adj.: VR6
Modulation defeat: Pop one leg of D16 out of PC board. Do not
pop C85.
Peak: T17, T18, L9, L12
Do not touch T19, as this is the TVI trap.

SPECIFIC RADIO TUNE-UPS (Cont'd)

REALISTIC TRC-422

IF AGC adj.: VR1
Squelch Range adj.: VR2
S Meter adj.: VR5
RF Meter adj.: VR6
Modulation defeat: Pop one leg of D16 out of PC board - do not
pop C85.
Peak: T17, T18, L9, L12 - do not touch T19, as this is TVI trap.

REALISTIC TRC-427

IF AGC adj.: VR1
Squelch Range adj.: VR2
S Meter adj.: VR3
RF Meter adj.: VR4
Modulation adj.: if you can't adjust, pop one leg of D19 out of
PC board. Do not pop C78.
Peak: L20, L16, L15, L12 - do not touch L9, as this is TVI trap.

REALISTIC TRC-440

IF Gain adj.: VR1
Squelch Range adj.: VR4
S Meter adj.: VR6
Modulation: Cut one leg of D109 - as last resort, pop one side
of C131 out of PC board.
Peak: L102, L104, L106 - do not touch L108 (TVI trap).
Note: RF meter has no adjustment; you make-take R184 out of
circuit and install 50 ohm trimmer and get adjustment.

REALISTIC TRC-454

Modulation adj.: VR-702 - and/or cut leg of D704
AGC adj. (RF): VR102
IF AGC adj.: VR301
Squelch Range adj.: VR502
S Meter adj.: VR501
SWR Meter: VR505 - calibration procedure: 150ohm carbon resist-
or across antenna input. Meter switch to calibrate position.
Adjust SWR cal. to calibrate. Meter switch to SWR. Adjust
VR505 for 3 on meter.
Peak: L901, L903, L907, L908 - do not touch F901 (TVI)
VR504: Power Meter adjustment.

REALISTIC TRC-471 (In-Dash AM/FM/CB)

AGC adj.: VR101
Squelch Range adj.: VR103
S Meter adj.: VR102
AMC adj.: VR2 and/or change R17 to 1Kohm
Peak only: L10, L7, L6, L4, L3, L1 - do not touch TC1 (TVI)
RF Meter adj.: VR1

LINEAR AMPLIFIER NOTES

MODIFICATION FOR PRIDE AND PALOMAR 100W LINEAR AMP

1. The big problem with most mobile amplifiers is over-drive. This causes distortion and T.V.I. The cure is to keep the AM modulation below 100% and the AM power at $3\frac{1}{2}$ W. This cannot always be done so the best thing to do is change the amp so you will not over-drive it with high power.
2. Locate the input transformer on the amplifier. This will have 3 turns of wire on it. Remove the wire and rewind the transformer for four turns. This effectively lowers the drive level to the amplifier.
3. Make sure you have good jumper cables and #8 or larger gage wire running to the amp from the battery. Note: Fuse this wire at the battery for 20 amps. I use four fuse links with 5 amp fuses in them and solder them to the #8 wire and tape the connection, and the other end I install a terminal lug. I like to connect this end at the starter solenoid, but this is not possible in every case. Connecting directly to the battery should only be done as a last resort, because of corrosion. The ground wire must be as short as possible - not over 12 inches. This must be connected to the vehicle or car with a star washer and a #12 or larger sheet metal screw or bolt. Make sure all paint or rust is removed from where the ground is connected. By doing this, you eliminate ground loops.
4. Your antenna should have a good ground if it is mounted on the trunk lip. Use grounding straps for the best ground connection.
5. Check your SWR. If it is not the same on low power or barefoot as with the amp on you have an antenna problem - bad ground or bad antenna. Check the coil spring on your antenna. It may be rusted or the strap inside the spring may be broken or corroded. The SWR should not move more than 1 or 2 points between barefoot operation or hi power. If it does you will fry your amp. Zap the transistors and you are out approximately \$20 each plus labor, so take care.



INSTALLING & TROUBLESHOOTING LINEAR AMPLIFIERS

1. Make sure the antenna is rated for the high power output of the amplifier. If you can't be sure, check with a reliable 2-way radio store or technician. The wrong antenna, or one badly adjusted will result in excessive amplifier heating and possible transistor damage.
2. Check antenna SWR on the lowest and highest frequencies used. (Wattmeter/SWR meter should be installed between the antenna and radio) Use a short (12" maximum) jumper between the radio and the SWR meter. It should be adjusted to less than 1.5 for maximum range and best results. Don't use the amplifier if you can't tune the SWR below 1.8 (amplifier off). Excessive SWR will reduce the power radiated by the antenna and cause excessive heating of the amplifier, and reduced transistor life. The SWR may rise a half point with amplifier operation.
3. Standard amplifiers are designed to operate with transmitters having maximum outputs of 4.25 W. carrier (12W PEP SSB). Amplifiers adjusted for higher power levels are noted on the rear of the chassis. (i.e., 6.5 carrier, 18W PEP SSB).
4. When you are sure of the above, then continue with the installation.
5. The amplifier should be installed in a location where the heatsink fins will be exposed to good air circulation, if possible.
6. Power hook-up is very critical. The transceiver and amplifier should use separate leads to the battery. The amplifier must be connected by heavy gauge wire in good condition. The wire size is determined by the output power, as indicated below: (Coax cable is not suitable)

<u>Output Power</u>	<u>Suggested Wire Size</u>
Up to 200 Watts	Use 10 ga. up to 8', 8 ga. over 8'
200 Watts and up	Use 8 ga. up to 8', 6 ga. over 8'
7. The BLACK power lead should be connected to the auto body. Check to see if the NEGATIVE battery terminal has a short ground return to the auto body. If not, you will need to connect a short jumper of 12 ga. wire with a suitable lug terminal to the battery post and auto body. Check the battery terminal condition. If corroded and not making good contact to the cable clamps, clean all wires, dress battery, install leads and add grease over terminals after tightening. Voltage loss and reduction of amplifier output will result from poor battery connections. Connect the RED power lead to the POSITIVE battery post thru suitable cable. (For POSITIVE ground vehicles, the amplifier must be of the "FLOATING GROUND" type. The BLACK wire goes to the battery NEGATIVE. The RED positive fused lead connects to ground. Also ground the wire connected to the amplifier's chassis.)

INSTALLING & TROUBLESHOOTING LINEAR AMPS (Cont'd)

8. Connect a cable between the amplifier and radio. Length isn't that important here - 3' or less will do. Use RG-8 or RG-58 cable. The length can be changed later to improve matching.
9. Connect the SWR meter between the antenna and amplifier. (Don't go any further if you don't have an SWR meter capable of measuring these output levels.) The lead between the amplifier "ANTENNA" connector and SWR meter should be less than 1 foot.
10. Switch the amplifier to the AM mode. Push the transmit button and release. The amplifier should turn on with the transmitter and then return to receive mode automatically. If it doesn't shut off with the transmitter; i.e. you don't hear stations on your radio and/or the RF indicator stays lit, this is an indication that the length of coax between the amplifier and radio (or antenna) may not be optimum. Increase the coax length 2-3 feet if possible. Sometimes you may need to change the antenna coax 3-5 feet to get the desired result. (This procedure is sometimes used where transmitter SWR sensing circuits inhibit operation with some antenna or with an amplifier.)
11. Test the SWR with the amplifier operating. It should be less than 2.0. If it isn't, repeat the antenna tuning process with the amplifier turned off but connected in the line. (If there is a significant increase in SWR with amplifier operation, there may be installation problems, i.e. amplifier grounding, interconnecting coax length, high antenna SWR, antenna not rated for power, transmitter not well grounded.)

TROUBLESHOOTING GUIDE

The majority of all problems encountered with linear amplifiers can be traced to improper installation - usually wiring or antenna. For many years of trouble-free operation, it is well worth the extra trouble of making a good installation with a suitable antenna. It would be worth your while to have your installation checked by someone experienced in high power transmitters or amplifiers. A few of the more common installation problems are:

Excessive Drive Power:

Excessive drive power will often cause distortion and "flat topping". Upward modulation and effective communications range is reduced. Also, the possibility of damage to the amplifier exists.

INSTALLING & TROUBLESHOOTING LINEAR AMPS (Cont'd)

Less than rated output power.

Most often traced to poor wiring or too small gauge wire, which causes excess voltage drop during transmit. Sometimes the transmitter is not putting out rated power when connected to the amp. Install a wattmeter between amp and transmitter. Key, and switch amp on and off. If forward power is substantially less when the amp is switched on, some improvement may be obtained in varying the cable length between amplifier and transmitter.

Feedback, whistle.

The amp may not be grounded properly, or may have high antenna SWR. Sometimes the microphone will pick up power, and requires a 220pF capacitor from each mic lead to ground inside the set. Power mikes can be a problem. Low supply voltage less than 13 volts under load at the amplifier.

Distortion, fuzzy sound.

Poor grounding of transmitter and amp. Ground each unit with a short jumper to the auto body or dash.

Amplifier remains on after transmitter is keyed off. Sometimes gets warm, resets if transmitter is switched off.

Suspect high antenna SWR, bad amplifier or transmitter grounding, improper coax cable length between transmitter or between amp and antenna. Open shield at coax connector (shield not making good contact with connector.)

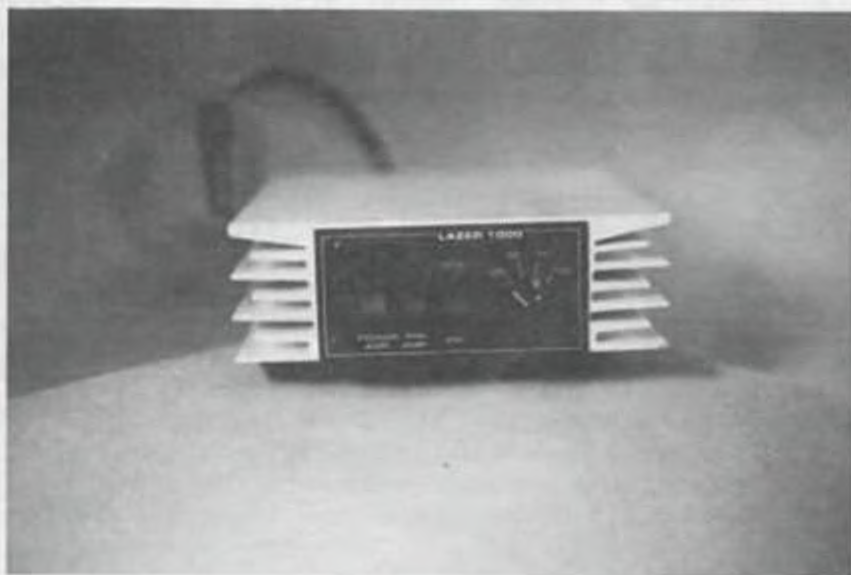

10 METER AMP BOARD MODIFICATION TO UPRIGHT DRIVER

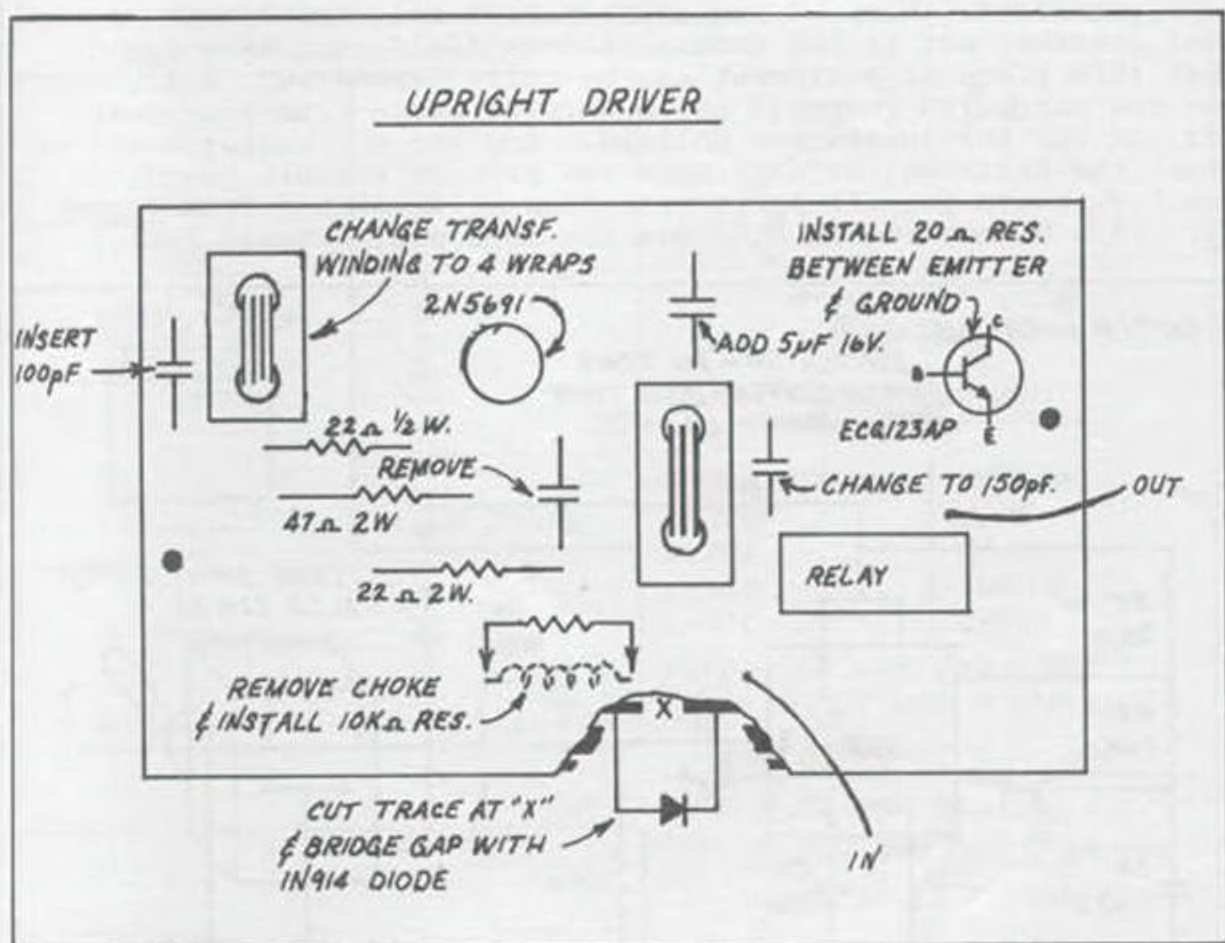

Have you ever wanted to use a high-powered RF amplifier, but your rig didn't have enough output to drive it? Well, with a little time and very little expense, here's how to modify the Uniden 10 Meter Power Conversion from Secret CB, Volume 4, pages 68-70. This modification will convert it to an upright driver with 20-25 watts and gives your rig the extra power you need for driving the big ones.

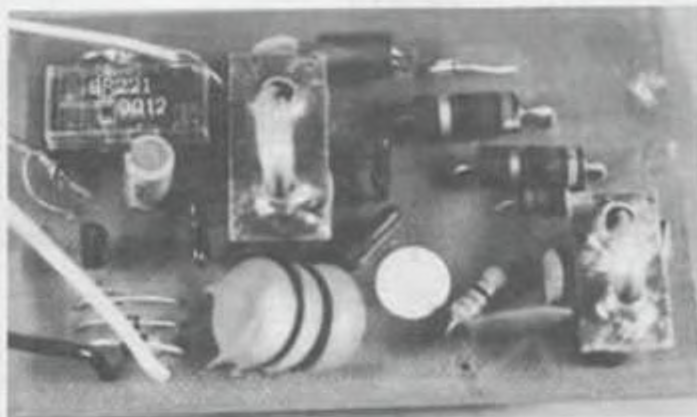

TWO TONE GENERATOR

Often in your repair jobs you will have need of a two-tone test generator. Many of you already have one, but for those just starting out in the communications field, you have found that this piece of equipment can be quite expensive. Well, here's one you can build yourself using surplus parts from your junk box, or buy for just a few dollars. You can use vector board to mount the parts on, or make your own printed circuit board, or the P.C. board and all parts will soon be available from Secret CB. (Can be mounted in Budd Box for more professional look.)

SWITCH POSITIONS:

SWITCH UP - HI TONE
SWITCH CENTER - DUAL TONE
SWITCH DOWN - LO TONE

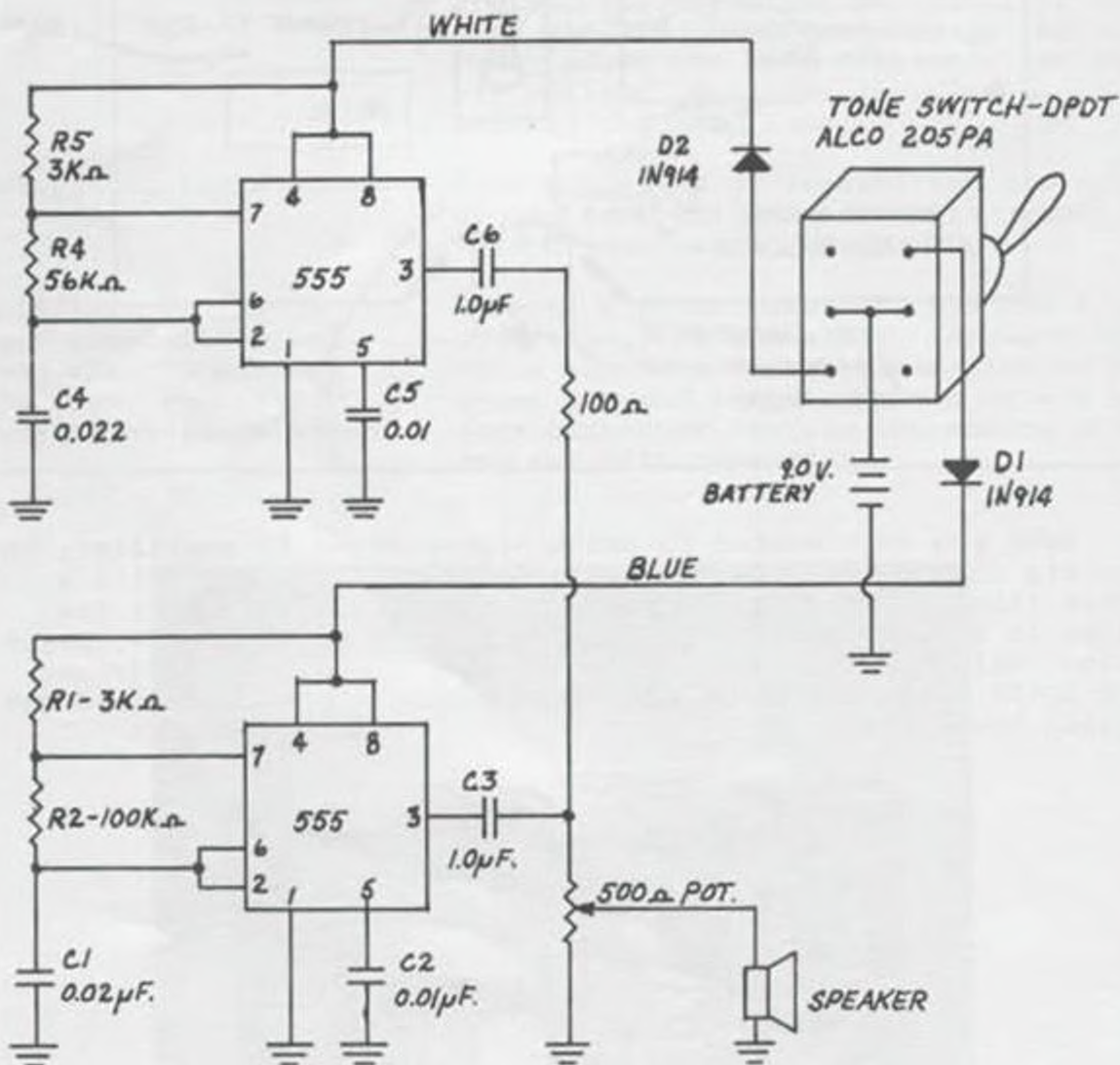

YAESII 601(B) FREQUENCY COUNTER MODIFICATION

TO READ CB LOW, MIDDLE, HIGH FREQUENCY

FRONT OF UNIT

TRANSFORMER

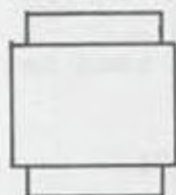

• E
• D
• C
• A
• B
• D
• A
• BL

MAIN BOARD

SWITCHES

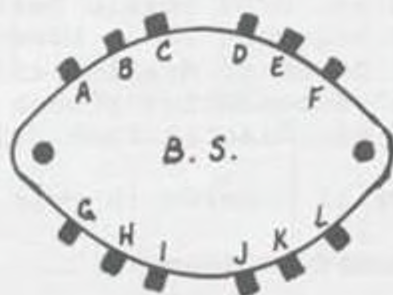

BAND SWITCH

E - AUX. 27MHz	YELLOW
F - 10D	BLUE
J - 10A	GRAY
K - 10B	PURPLE
L - 10C	GREEN

NOTE: E & L HAVE TWO WIRES TO THEM AFTER MOD. IS COMPLETED.

B.S. = BAND SWITCH

SW.1 \triangle A TO DIODE BD. \triangle B B.S. F
 \triangle C BLUE WIRE THAT \triangle D GR. WIRE
 WAS AT B.S. F THAT WAS AT
 \triangle E B.S. L \triangle F B.S. L

SW.2
 \triangle A WIRE TO DIODE BOARD.
 \triangle B B.S. K
 \triangle C PURPLE WIRE THAT WAS AT B.S. K
 \triangle D GRAY WIRE THAT WAS AT B.S. L
 \triangle E B.S. J
 \triangle F WIRE TO DIODE BOARD.

SW.3
 \triangle E B.S. F \triangle F B.S. L



PIN I.D. SAME FOR ALL 3 SWITCHES.

INSIDE BACK OF UNIT

YAESU 601(B) FREQUENCY COUNTER MODIFICATION

TO READ CB LOW, MIDDLE, HIGH FREQUENCY

1. Parts Needed:
 - 3 ea. DPDT Toggle Switches
 - 9 ea. good 1N914 Diodes
 - 1 piece of drilled circuit board, 1" X 3"
 - 4' 4-conductor ribbon wire
 - 3 ea. Plastic Draw Straps
 2. Drill 3 holes in rear center of counter.
 3. Mount switches
 4. Remove gray, purple, green and blue wires from band switch at specified location (see drawing)
 5. Hook above wires to proper switches (see drawing)
 6. Run wires from rear toggle switches to band switch (see drawing)
 7. Hook up diode board (see drawing)
 8. Use double-sided tape and put diode board on top of transformer. Use tape for two reasons; it cuts down on vibrations and also acts as an insulator.
 9. Now counter will work regular, or as follows:
 - 10A will cover 26.000 to 26.500
 - 10B will cover 26.500 to 27.000
 - 10C will cover 27.000 to 27.500
 - 10D will cover 27.500 to 28.000
- NOTE: Switches must be in up position for modification and down for standard operation.

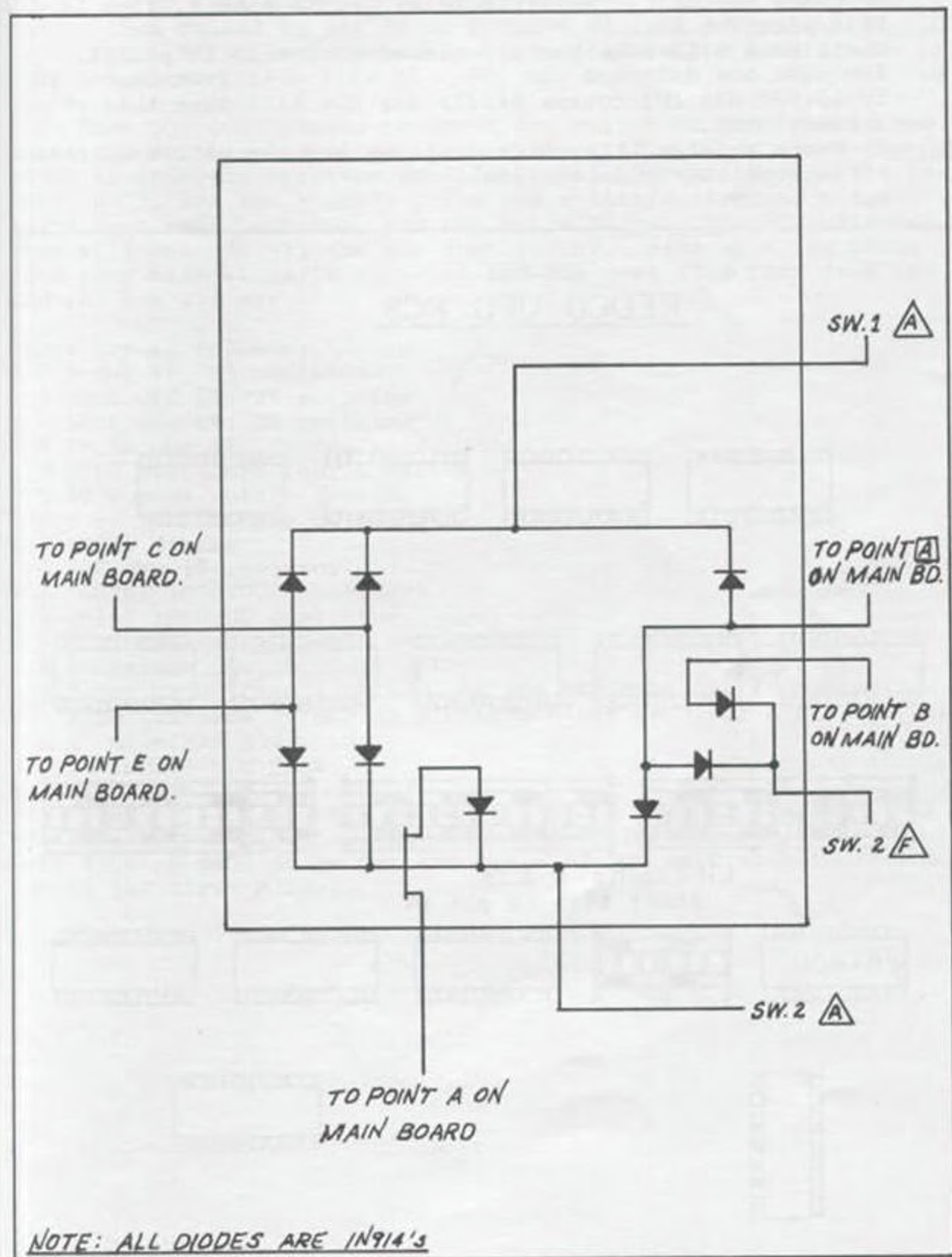

REDCO UFO MODIFICATION

1. Locate CD-4011 IC (First chip that runs parallel with the front, located in the right rear).
2. Note the CD-4011 is a 14 pin chip; locate pins 8, 13 & 14.
3. Lift pins 8 & 13.
4. Tie pins 8 & 13 together and tie both of them to pin 14.
5. You have now unlocked the UFO. It will scan from 20.000 MHz to 29.995 MHz (Of course hardly any CBs will tune that wide a bandwidth).

*Note: Use a grounded tip soldering iron and use as little heat as possible to do the job.

REDCO UFO PCB

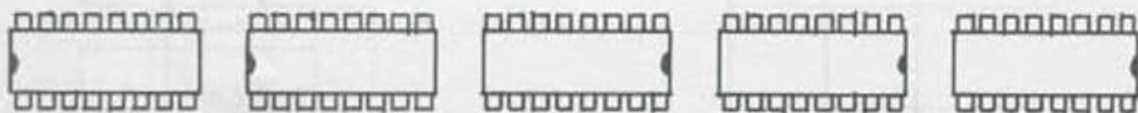
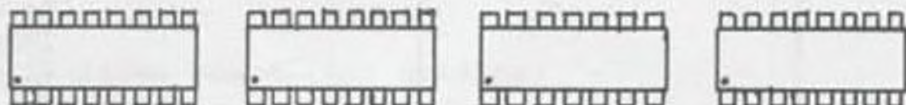

LIFT pins 8 & 13
Short both to pin 14

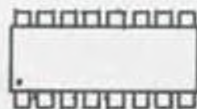
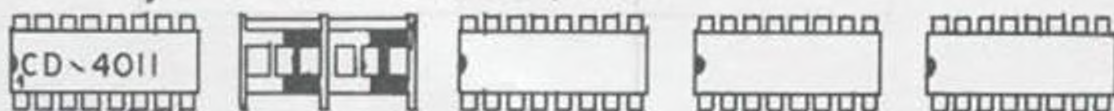

RF TEST METER

NOTE: We owe our readers an apology for a bit of confusion we caused over this item. In volume 7 we made mention of an RF test meter to be found elsewhere in the book, and then failed to put it in because of lack of space. So, here it is, and we hope we didn't cause too much inconvenience.

Have you ever wanted to check the output of your PLL to see if it was working, or align it to maximum RF out, or chase the mixer RF from the receiver oscillator all the way through the radio? Well, now for a small price and a little time and a few parts from your junk box, you can build Secret CB's RF Voltmeter that will measure all the way down to .5V. Pick up a few parts from your nearest parts supplier and the rest from your junk box and you are all set.

Parts are as follows:

- 2 @ 2 meg $\frac{1}{2}$ W, 2% resistors
- 1 @ 300K ohm $\frac{1}{2}$ W, 2% resistor
- 1 @ 100K ohm $\frac{1}{2}$ W, 2% resistor
- 1 @ 17.5K ohm $\frac{1}{2}$ W, 2% resistor
- 1 @ DPDT miniature toggle switch
- 1 @ ST 6 pole rotary switch
- 1 @ 0 to 50 microAmp DC meter
- 3 @ 1N914 diodes
- 1 @ 10K ohm $\frac{1}{2}$ W resistor
- 2 @ .002pF 1000VDC capacitors
- 1 @ .01pF 1000VDC capacitor
- 1 @ SPDT miniature toggle switch
- 1 @ Miniature box to house meter
- 1 @ Scope probe case from ICO, or you may make one from a metal 35mm film can or use an aluminum cigar case, or a pill bottle.
- 1 @ $\frac{1}{4}$ " male mic plug
- 1 @ $\frac{1}{4}$ " female mic jack

Mount all parts in a convenient place in your box and, with a little care you will have a valuable test instrument that would cost \$100 to \$200 to go out and buy - if you were able to locate one in the first place.

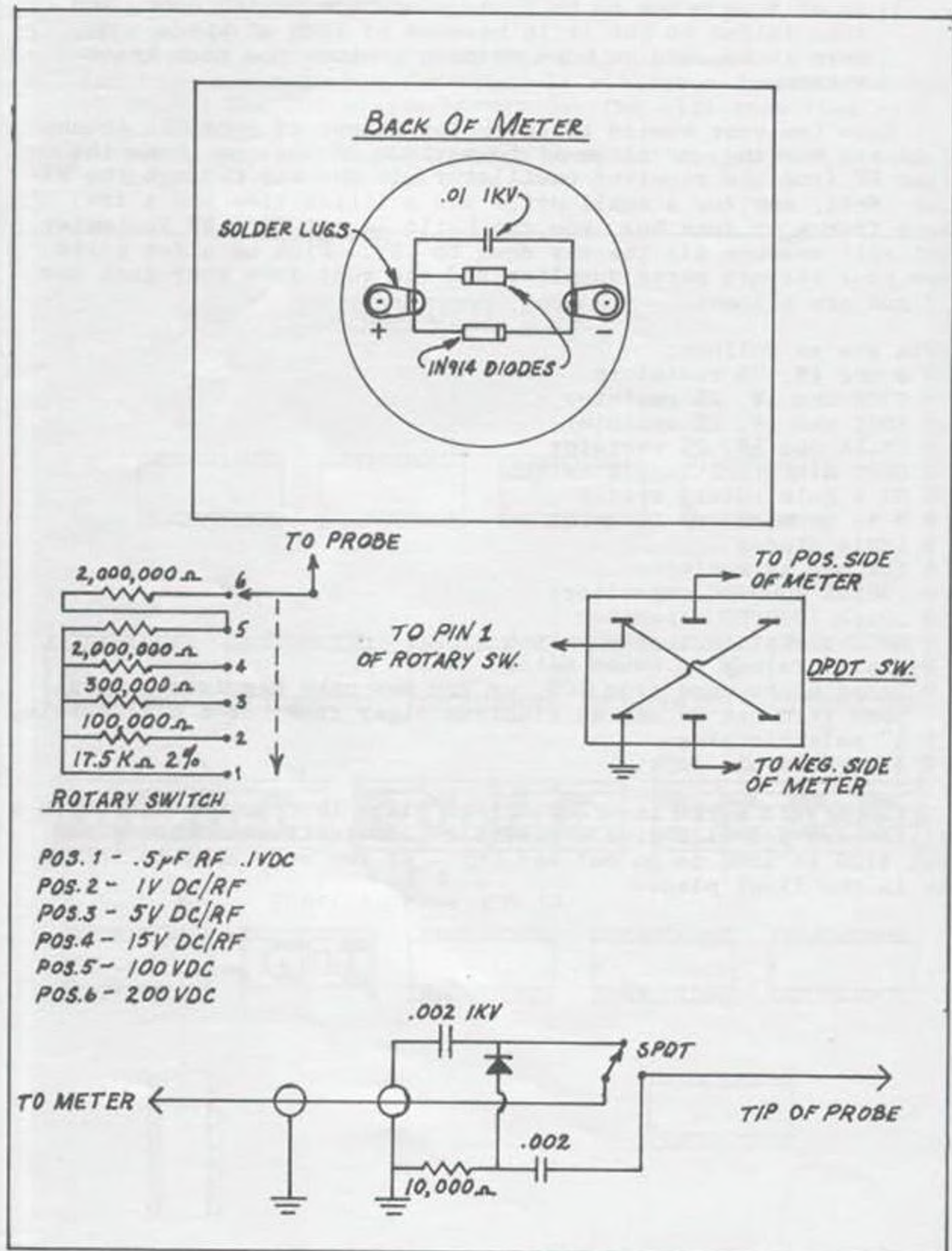

SECRET CB'S POWER VECTORING

I. AM MODULATED CARRIER

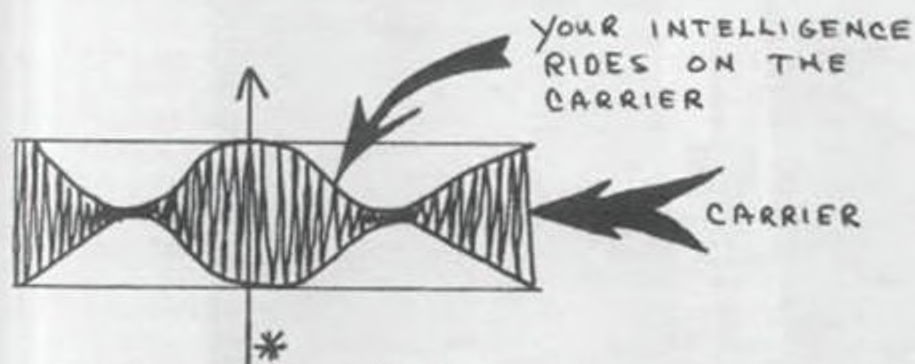

ARROW POINTS WHERE YOU WILL HAVE STRENGTH IN AN AM SIGNAL. ADDING POWER WILL HELP - ALSO SPEECH PROCESSING.

II. FM CARRIER WITH DEVIATION

NO REAL HELP HERE, 5KHZ DEVIATION IS USUALLY ALL THAT IS ALLOWED.

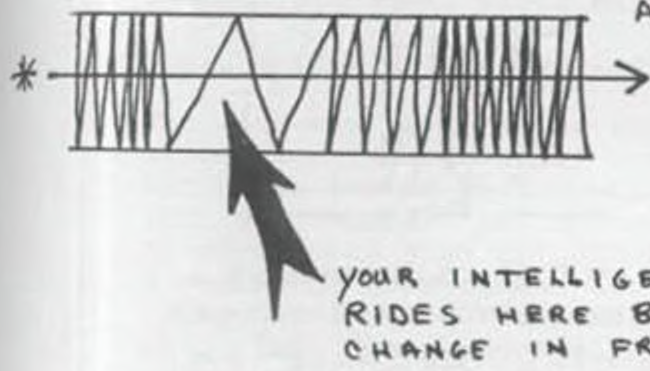

III. SINGLE SIDE BAND



SINGLE SIDERAND IS PURE INTELLIGENCE. ECHO BOX HELP IN THIS CASE (SEE NEXT PAGE.)

* —————> DENOTES WHERE STRENGTH SHOULD BE APPLIED OR WHERE YOUR EFFORT TO GET MORE POWER SHOULD BE APPLIED.

HOW THE ECHO BOX CAN ACTUALLY SURPASS THE POWER OF A LINEAR IN SSB

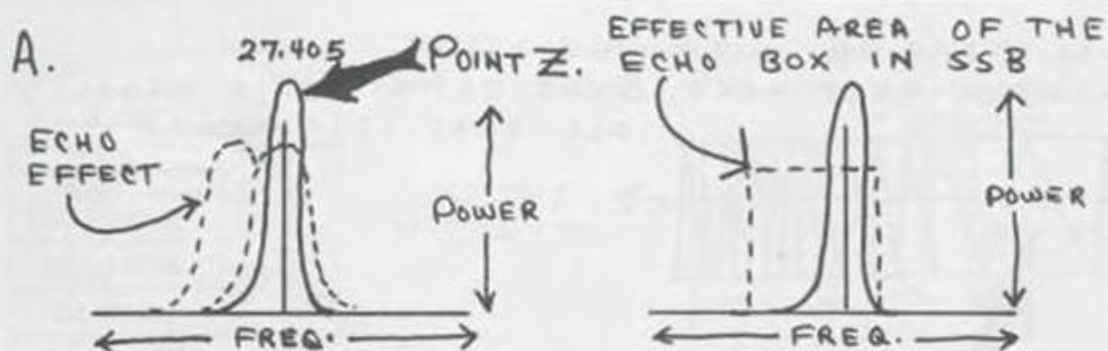

NOTE: EVEN THOUGH POINT Z SIGNAL IS MORE POWERFUL, THE ECHO BOX WILL SOUND THE MORE POWERFUL, SIMPLY BECAUSE IN SSB MODE, THE ECHO OCCUPIES MORE SPACE IN THE FREQ. SHOWN.

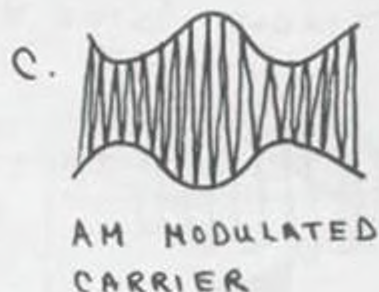
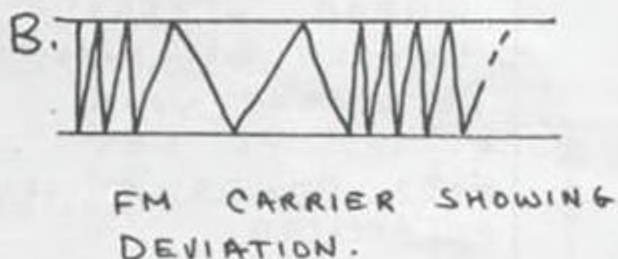

MICROMONITOR QUESTIONS

- Q. What does the Micromonitor really do?
- A. Within any PLL radio there is a miniature computer that programs the radio to operate on certain frequencies or channels. The Micromonitor replaces the stock PLL circuitry with a computer of its own to add new functions which weren't available to you before.
- Q. Can the Micromonitor control any PLL radio?
- A. Generally, yes. With the Micromonitor's own PLL and electronic switching, you have the choice of normal radio operation when the MM-1 is removed or turned off.
- Q. Can the clarifier in a SSB radio be adjusted with the Micromonitor?
- A. No. The clarifier is manually adjusted, and must be modified for additional slide. The extra slide will not appear on the Micromonitor control.
- Q. What frequency steps can be resolved?
- A. In general, 5 KHz steps may usually be achieved.
- Q. What is involved in the installation?
- A. The best way to describe the integration of the Micromonitor is to describe basically how to install one. The Micromonitor comes in two parts: the hand-held control unit and the interface board. The interface board mounts within the radio, or when space does not permit, on the outer case of the radio. A series of connections are required: +12V, Ground, Push-to-talk, Squelch, VCO Output, Phase detector output, and VCO input. And, for those wanting the tone encoder, an additional wire connecting to the audio (microphone) is also required. In each case except one, the connection simply involves paralleling a connection within the radio. One internal connection, the phase detector to VCO input, must be separated and each of these signals are brought to the interface board for connection. Finally, a socket assembly is installed at the rear of the radio so that the Micromonitor may be connected. When the Micromonitor is plugged in and turned on, the electronic switching within the interface board automatically interrupts the radio's control signal to the VCO and, instead substitutes a control voltage of its own. In this way, the Micromonitor assumes control of the radio's frequency selection circuits. When the Micromonitor is turned off or unplugged, the radio is returned to normal operation.

MICROMONITOR QUESTION CONTINUED:

- Q. On what radios will the Micromonitor work?
- A. If the radio is a PLL type, the Micromonitor can be made to work. This includes CB radios, converted 10 meter radios, 2 meter types, 220 MHz and 450 MHz types. Fortunately, the rules governing PLL synthesis are all basically the same. As such, the Micromonitor can generally be made to work.
- Q. What are the power requirements?
- A. The Micromonitor only needs 12 - 15 VDC for operation. Included with the system is a voltage regulator used to supply all necessary power to the added circuitry.
- Q. Is 10 meter operation possible on a converted 11 meter radio?
- A. If the converted radio is a PLL type, then the Micromonitor can be used for control, including the correct frequency or channel readout. Provision exists within the Micromonitor for identifying the correct frequency desired. The only requirement is to identify to the factory the amount of shift of the output frequency (usually 2MHz) so that the readout will read correctly.
- Q. Can the Micromonitor be used as a remote control?
- A. The Micromonitor is designed to replace or augment the channel selector switch. Its purpose is not to assume all of the front panel functions of the radio. However, if the other controls of the radio could be preset, then the only function that needs to be used is that of power control, which may be done with a simple switch or relay assembly. In this case, the Micromonitor could be used as a remote control.
- Q. How do you know where you are operating?
- A. The Micromonitor displays the particular channel or frequency that is currently in operation.
- Q. Can the same Micromonitor be used on different radios?
- A. The only way the same Micromonitor can be used on different radios is if the same radio chassis type is used on both radios. Each radio has its own set of operating constants; within the Micromonitor is a memory device designed to identify the particular constants to the master chip within the Micromonitor. If the user has set up his radio for use with the Micromonitor and then replaces his radio, he can adapt the Micromonitor to the new radio by returning the unit to the factory. The factory will adapt the Micromonitor for use within the new radio at nominal cost.

MICROMONITOR QUESTIONS CONTINUED:

- Q. Can the Micromonitor be used on crystal controlled radios?
- A. No, the Micromonitor is designed for use only with PLL radios. It is planned, however, to provide an adaptor for crystal type radios at a later date.
- Q. How many memory channels are provided?
- A. There are five user loadable memories in addition to a fixed "HELP" frequency all of which may be recalled at a keystroke.
- Q. How many scanners are provided?
- A. There are three scanners, two automatic and one manual. The automatic scanners will scan the memory channels or will scan the entire band. The scanners may be programmed to look for either busy or clear frequencies as indicated by the squelch control. The manual scanner will scan as long as the "STEP" button is depressed. The scan direction is controlled by the "UP/DN" button.
- Q. Is the Micromonitor easy to install?
- A. The Micromonitor installation is fairly easy to install. However, great attention to detail must be observed. In normal applications, the installation time will be about one hour. The Micromonitor should be installed by experienced service technicians.
- Q. Do the memories retain their information if the Micromonitor is switched off?
- A. Unfortunately, the memories are lost if power is lost or the Micromonitor is switched off. When power is reapplied, the memories must be reprogrammed manually.

MICROMONITOR INSTALLATION INSTRUCTIONS

SEARS ROADTALKER SERIES

J.C. PENNEY'S USING SM5104 CHIP

1. Assure supplied parts conform to list:
 - 1 ea. Micromonitor control unit
 - 1 ea. Interface board
 - 1 ea. LM340T-5 voltage regulator
 - 1 51k resistor
 - 1 Tru-arc ring
 - 4 ea. plastic spacers
 - 8 ea. 4-40 x $\frac{1}{4}$ " screws
2. Remove cover from radio
 - (a) select a location to mount interface board. Assure NO interference. Speaker location may need to be altered.
 - (b) refer to figure. Install interface board and voltage regulator to selected location.
 - (c) punch $\frac{1}{8}$ " hole at back of radio. File notch to accept jack on interface board. Secure with tru-arc ring.
3. Place radio foil side up.
4. Cut traces connected to pin 6 and pin 7 SM5104 chip.
5. Jumper trace perviously connected to pin 7 to pin 8.
6. Make connections directly to chip as follows:
 - Yellow - to pin 6
 - White - to trace perviously connected to pin 6
 - Violet - to pin 4
 - Grey - to pin 2
 - Black - to pin 16
 - Orange - to pin 8
7. Parallel R131 (near Q108) with 51k resistor.
8. Connect green wire to collector Q108.
9. Connect blue wire to R142 (opposite end connected to D113 near Q108).
10. Connect red wire to +13.8VDC switched.
11. Install jumper between pads 4 & 5 on interface board.
12. Power on - cycle MM1 from off to on - display should read "CH 19". Verify xmt. frequency of 27.185 MHz.
13. Depress "HELP" button. Verify xmt. frequency of 27.065MHz.

NOTE: pads 1 & 2 are intended for amateur use only. Do not allow a short circuit to exist between these points for Class D Citizen's Service.

MICROMONITOR WIRING INSTRUCTIONS

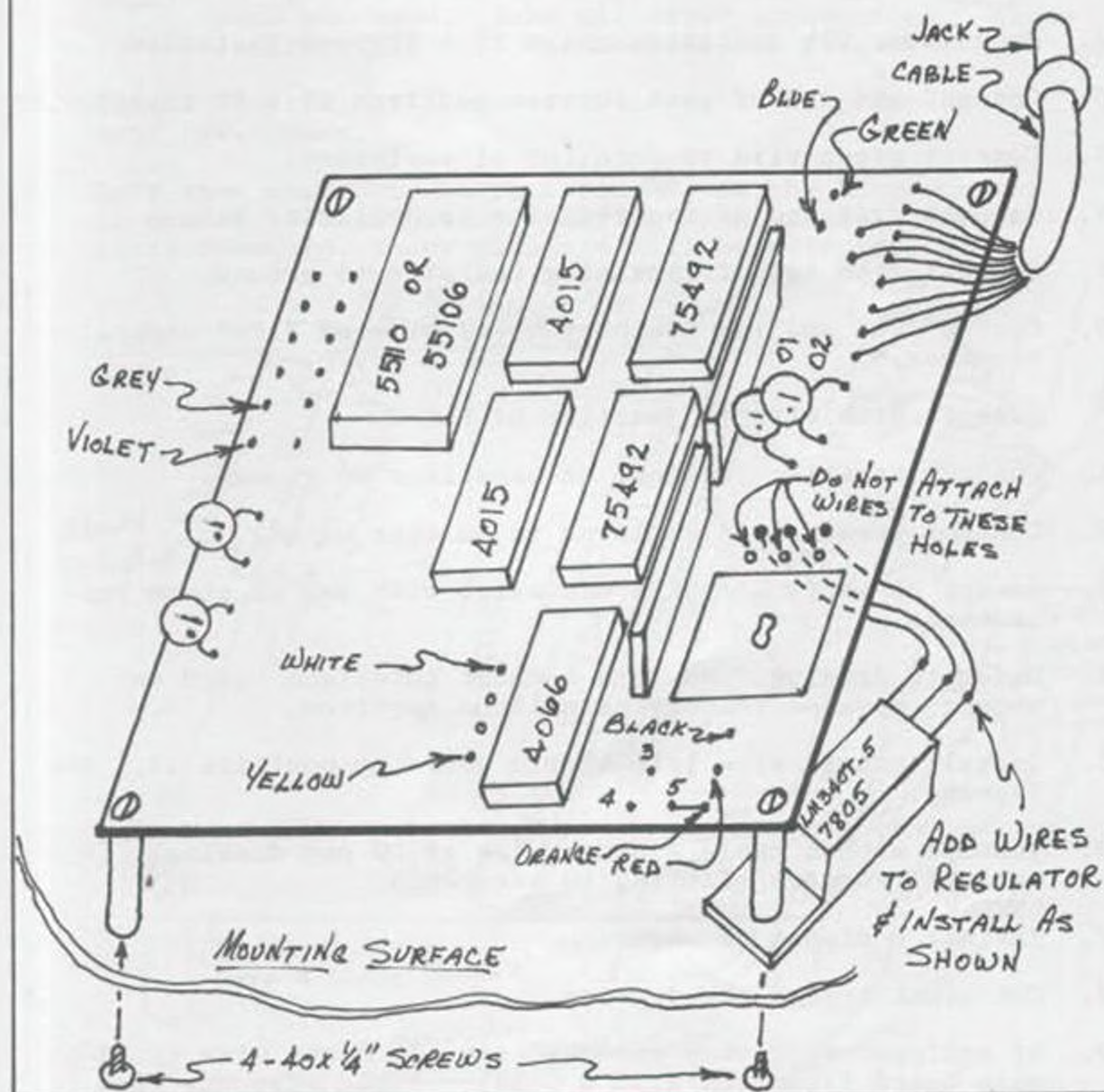

ICOM 22S MICROMONITOR INSTALLATION INSTRUCTIONS

1. Verify parts list and assure all are present.
 - 2 ea. 22k resistors
 - 1 ea. 10k resistors
 - 8 ea diodes
 - interface board unit
 - Micromonitor unit
 - 4 ea. spacers
 - 8 ea. screws
 - 1 ea. LM340T-5 regulator
2. Remove C55 on main board (3.3mf), lay aside for later use.
3. Remove R7 & R8 beneath diode program board. Lay aside for later use.
4. Substitute 22k resistors where R7 & R8 were installed.
5. Connect one end of each 10k removed from R7 & R8 together.
6. Connect green wire to junction of resistors.
7. Connect free end of one resistor to collector Q11.
8. Connect free end of remaining resistor to ground.
9. Connect one end 10k resistor & (+) side of 3.3mf capacitor together.
10. Connect blue wire to junction of R & C.
11. Connect negative terminal of capacitor to ground.
12. Connect free end of resistor to emitter of Q32.
13. Assure no short circuits can exist with any of above connections.
14. Refer to drawing. Measure & mount interface board as shown. Speaker relocation will be required.
15. Install orange wire into matrix board at position 22. See drawing.
16. Install ribbon cable - Brown wire at D \emptyset per drawing. (Ribbon will require slitting to stretch.)
17. Install 8 diodes as shown.
18. Cut eight traces per drawing.
19. If equipped with tone encoder, install brown wire to J3 on main board (junction R130 & C159). *This wire may need to be substituted with shielded cable to minimize audio pickup.

MICROMONITOR - ICOM 22S
INSTALLATION INSTRUCTIONS

20. Install LM340T-5 regulator per drawing. Attach wires to interface board.
21. Connect red wire to +12VDC switched.
22. Connect black wire to circuit ground.
23. Install jumper between Pads 1 & 2, also between 4 & 5.
24. Install jack into rear panel. If installation is difficult, jack may be cut off and use 9 pin connection instead.
NOTE: 10 wires are inside cable. Orange wire is only wire not used. Make all other connections. Similar rewiring will be necessary on plug.
25. PWR on - cycle MM1 from 'off' to 'on'. Display should read 147.000MHz.
26. Only when switch is in position 22, is the Micromonitor in command. When selector switch is in standard synthesized channels, those channels will be selected.

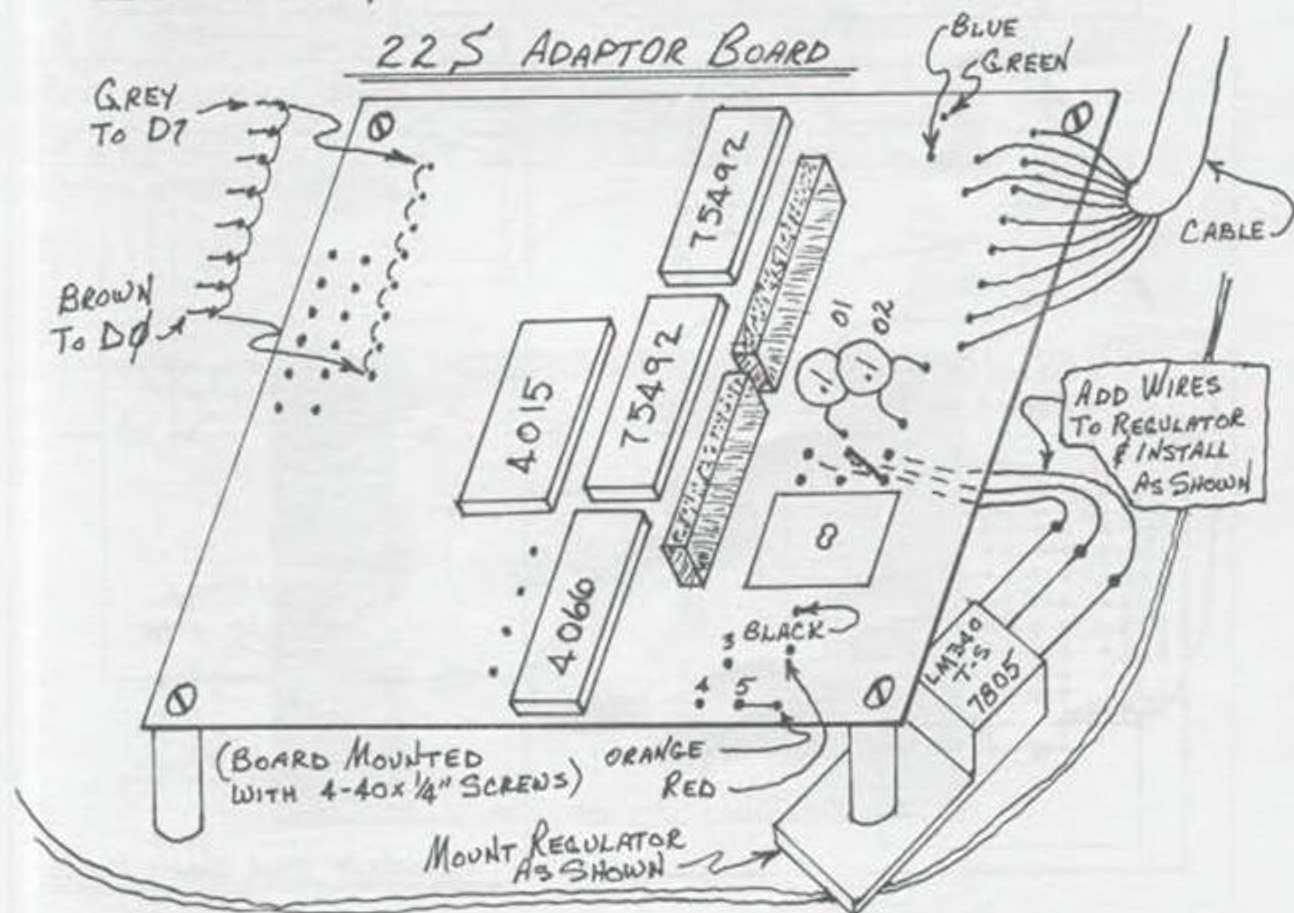

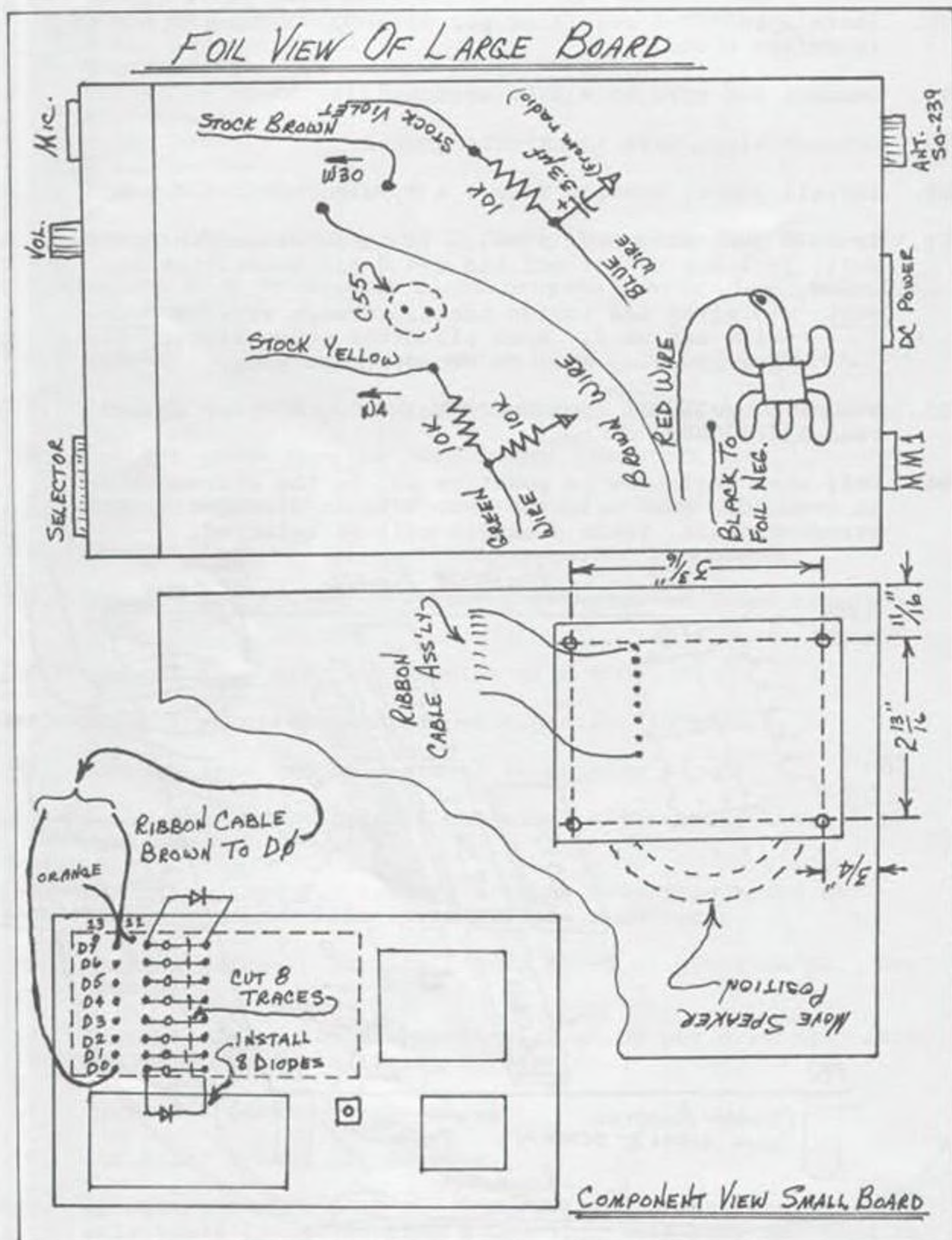

NEW PRODUCT RELEASE - ZAPPER 9000

Here's a new kit, just release, for those hard to modify radios, such as Cobra 29, 87, 89, 1000 GTL, some of the President AM radios, Midland, Realistic, Sears, etc. (See list on following page). The Zapper 9000 is a small module which will mount with very little trouble in most of the AM radios now on the market, and give those radios 120 operating channels.

The Zapper 9000 comes in three models, giving you a choice of 6 operating ranges, as follows:

Model 1: High Range - 27.415 - 27.855

Low Range - 26.515 - 26.955

(For those who wish to operate odd low and odd high)

Model 2: High Range - 27.415 - 27.855

Low Range - 26.510 - 26.950

(For those who wish to operate even low and odd high)

Model 3: Low Range - 26.510 - 26.950

Low Range - 26.515 - 26.955

(Giving you odd and even low frequencies for those who prefer to operate on low frequencies only)

The Zapper 9000 can also be modified for other uses according to your specific needs, such as: reference oscillator for 455 IF, 7.8 IF, or 16.6 IF. It can also be used as a crystal checker. When you order, specify your needs, and the module will be built for your purpose. The Zapper 9000 is available from California Advance Research Systems, or from your favorite parts supplier.



ZAPPER 9000
REFERENCE CHART

<u>MANUFACTURER</u>	<u>MODEL</u>	<u>SAMS</u>	<u>CHIP(PLL)</u>	<u>AMC</u>	<u>CAP. TO REMOVE</u>	<u>POINT OF REFERENCE</u>
Cobra	29GTL	217	D2816G	VR4	C87	TP11
Cobra	87GTL	243	D-2816G	VR6	C79	TP8
Cobra	89GTL	235	D-2816G	VR6	C79	TP8
Cobra	1000GTL	235	D-2816G	VR6	C79	TP8
Colt	190	---	LC7120	R71	C36	
Colt	222	236	LC7120	RV201	C205	P13/IC202
Convoy	Con-400	183	D861C	R129	C57	TP5
Craig	L101	240	MC14526CP	R226	C11	G ₂ - Q5
JC Penny	981-6221	227	D861	D501	C307	TP2
JC Penny	981-6237	228	D861	D7	C248	base/Q208
Lafayette	Telsat 1240	242	SM5107	VR305	C133	T106
Lake	650	214	SM5107	R218	C425	TP4
Lake	750	213	MC14526	R226	C11	G ₂ -Q5
Midland	76-860	250	TC9102P	R218	C117	TP3
Midland	77-101B	252	LC7120C	RV201	C205	P13/IC202
Midland	77-101C	270	LC7120C	RV201	C205	P13/IC202
Midland	77-824	---	LC7120	RV201	C205	P13/IC202
Midland	77-856	216	K76026	VR5	C104	L23
Pace	8008	164	SM5107	R218	C424	T16
Pace	8041	152	SM5118F	R302	C25	Base - Q3
Pace	8046	153	SM5118F	R302	C25	Base - Q3
Pace	8047	224	SM5118F	R302	C25	Base - Q3
Pace	8117	240	SM5107	R220	C420	TP2
President	Dwight D	229	D2816C	VR6	C79	TP8
President	Old Hickory	187	KM5624	VR5	C79	Base-TR9
President	Thomas J	218	D-2816C	VR4	C87	TP11
President	Zachary T	223	D-2816C	VR6	C79	TP8
Realistic	TRC-422	270	D2814C	Q11	C39	TP2
Realistic	TRC-440	208	D861	D107	C20	TP4
Realistic	TRC-452	178	D858	VR207	C4	Pin 8
Realistic	TRC-461	180	D861	VR2	C99	base-Q27
Realistic	TRC-466	194	D861	148	C18	L2
Realistic	TRC-467	171	D861	D109	C18	P3/IC2
Realistic	TRC-468	183	D861	R42	C248	base-Q208
Realistic	TRC-469	229	KM5624	VR5	C93	TP10
SBE	Aspen 41	220	SM5107	VR203	C424	G ₂ - Q27
SBE	Cortez 42	205	SM5107	VR203	C424	G ₂ - Q27
SBE	Keycom 54	212	MM55106N	RV1	C425	T401
SBE	LCB-8	272	D861	VR6	C79	TP8
SBE	Malibu 44	211	MC14526b	R226	C11	G ₂ - Q5
SBE	Tahoe 49	173	D861	R129	C57	TP5
SBE	Trinidad 45	204	MC14526	R226	C11	G ₂ - Q5
Sears	370.38050700	193	SM5107	R218	C425	TP4
Sears	934.38060700	226	D861	D7	C248	base-Q208
Sears	934.38062700	236	D861	R42	C248	T206
Sears	934.38080700	208	D861	D7	C248	base-Q208
Sears	934.38081700	225	D861	D501	C307	TP2
Sears	934.38110700	209	D861	D501	C307	TP2
Sears	934.38120700	201	D861	D501	C307	TP2
TRS	Challenger 1200	270	TC9103C	R9	C111	base-Q103
Teaberry	Stalker V	281	D2816G	VR4	C87	TP11

NEW PRODUCT RELEASE

REDCO DIGI-SCAN UFO ELITE

Redco just release the new UFO Elite that we've all been waiting so long for. It functions pretty much the same as the old Digi-Scan UFO, but with a couple of new features.

It still has the same operating frequency range, giving the AM-SSB operator a total of 1200 channels. In addition, a home channel feature, new to the Elite, lets the operator return to his home channel (Ch. 16) by simply pushing a button. If you should have a different home channel you wish to operate from, you can buy a kit to make the home channel programmable, for a small piece of change.

Another new feature is an "out of lock" indicator. Using this feature, the operator knows if his rig is operating on the frequency displayed by the UFO. If the radio is out of lock, the first digit on the UFO display will indicate "L", instead of "2".

Programming of the UFO Elite is done by means of rocker switches and easy to follow directions. Installation and alignment procedures are clear and concise, and should present no problems, if you have proper equipment. For extending your rig's capability, this is the way to go, and cheap at the price.

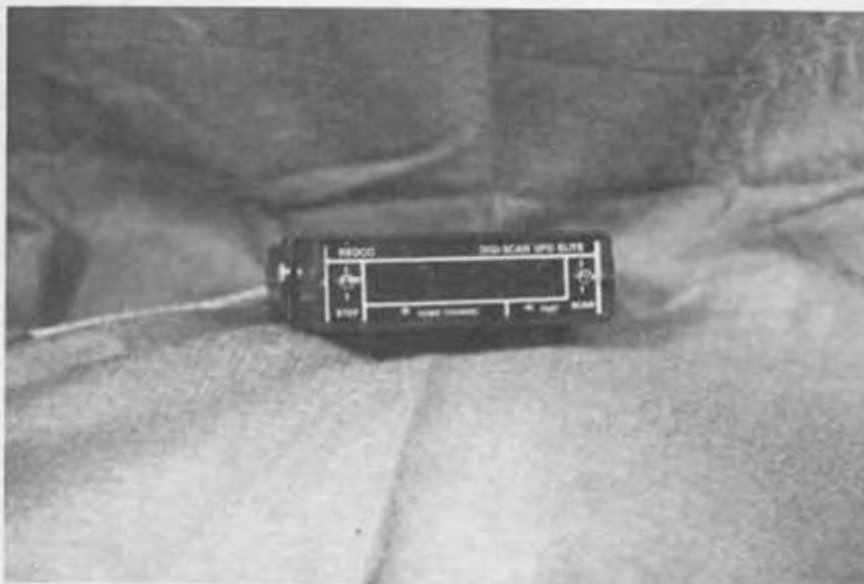

NEW PRODUCT RELEASE

CHOPPER CHARLIE ANTENNA, MODEL 64#5

Chopper Charlie in Cridersville, Ohio, has a new antenna design (Chopper Charlie, Model 64#5) which they asked us to check out and report on. We think it's a good one, and I think you'll agree.

We checked it out thoroughly and found it to be a fine omni which lives up to Chopper Charlie's claims. It's a well-constructed antenna, using heavy aircraft-type aluminum tubing. The only weakness we found in its construction was in the ground radial attachments. The screws used to secure them aren't really strong enough to withstand the kind of winds we have in this area at times. Bolts should cure this problem, however. The antenna is light-weight and can be easily handled by one man. Weatherproofing is also outstanding, which is an important factor in coastal areas.

SWR is good - 1.1:1 over 26.965 to 27.405, but with a severe increase outside this band. We used 70' of RG58 and then changed to the same length of RG8 with no change in SWR. TX-RX is good with a 50-mile radius and will handle power up to 250 watts.

SPECIFICATIONS

The antenna's .64 wavelength design develops a power gain equal to 15 watts talk-power when using a 3-watt transceiver (5db).

OVERALL HEIGHT: 23' - 3½"
DIAMETER OF RADIATOR - 1-1/8" to 3/8"
DIAMETER OF RADIALS - 5/8" to 3/8"
MOUNTING BRACKET ACCEPTS UP TO - 1-5/8"
WEIGHT - 8lbs.
WIND SURVIVAL - 90 mph
ALUMINUM TUBE - Aircraft Type, Heavy Wall

The matching transformer is impervious to weather, and provides a DC path to ground to bleed off precipitation static.

**SEE YOUR LOCAL CB DEALER
OR ORDER DIRECT**

SECRET CB ORDER FORM



Volume I



Volume II



Volume III



Volume IV



Volume V



Volume VI



Volume VII



Volume VIII

SELMAN ENTERPRISES, INC.
P. O. Box 8189
Corpus Christi, Texas 78412

- | | |
|---|--|
| <input type="checkbox"/> \$12.95 Vol. I | <input type="checkbox"/> \$12.95 Vol. V |
| <input type="checkbox"/> \$12.95 Vol. II | <input type="checkbox"/> \$12.95 Vol. VI |
| <input type="checkbox"/> \$12.95 Vol. III | <input type="checkbox"/> \$15.95 Vol. VII |
| <input type="checkbox"/> \$12.95 Vol. IV | <input type="checkbox"/> \$15.95 Vol. VIII |

Phone 512 992-1303 If You Wish To Order By Phone.

SHIP TO:

Name _____

Address _____

City _____ State _____ Zip _____

Ship Via: UPS First class Parcel post Other _____

Send Check, M.O. or C.O.D. only. Add \$1.00 per book for shipping. Visa, Master Charge accepted. Add 3% for handling.

Selman Enterprises, INC.

6341 S. PADRE ISLAND DRIVE - P. O. BOX 8189 - CORPUS CHRISTI, TEXAS 78412 - (512) 992-1303

NEW PRODUCT SURVEY

SECRET CB's "TROUBLESHOOTER"

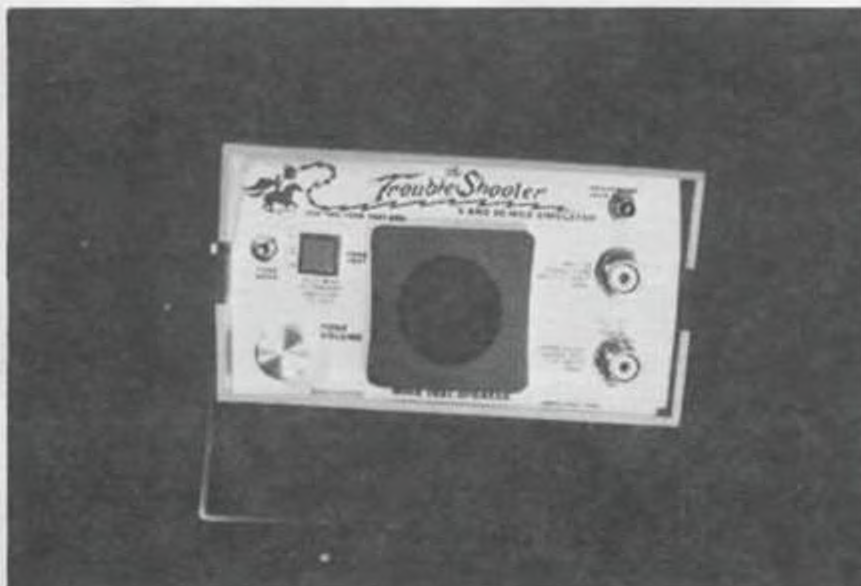

In Secret CB, Volume 7, we ran a brief description of the prototype "troubleshooter", shown here. Our purpose was to see if there was enough interest from our customers to justify going into full production. The response is encouraging. For those of you interested in having us put them on the market, fill out the form below and return it to us, or drop us a post card, indicating your interest in the Troubleshooter. If we get enough response we will start production soon. (Est. dlr. price: \$99.95)

NAME: _____ TELEPHONE #: _____

COMPANY NAME: _____

ADDRESS: _____

Please state if the "Troubleshooter" will be used as a Sales/Service aid in your business, or for personal use:

WOULD YOU PREFER:

Factory assembled _____

Kit form _____

SECRET CB INDEX

VOLUMES 1 THRU 7

10 METER CONVERSIONS:

RADIO	VOL/PG	RADIO	VOL/PG.
BOMAN CB930	3/21	HALLICRAFTERS HCM271	5/50,51,
CB950	5/39		6/39
CBH990	5/43	HYGAIN 1-A	1/22
BROWNING LTD	1/53	PLL	1/31
MKIII	6/28		
MKIV	6/29,30	MIDLAND 79-893	2/20
MKIV, IVA	7/8-13	79-900	5/47
		MORSE 3005	2/27
COBRA 32XLR	4/47		
132B	1/53	NESCO 1249	6/38
135B	1/53		
135XLR	4/38	PACE 8092	6/35,36
138XLR	1/20,23	PALOMAR 500	4/19,20,
139XLR	1/20,23		5/32-36
140GTL	3/19,20	PEARCE CHEETAH PLL	1/31,32
2000 (C.A.P.)	6/23	SIMBA PLL	1/31,32
2000GTL	5/20,7/	PRESIDENT ADAMS	2/16
	15-17	GRANT	1/22,23,59
COLT SX33	3/4-7		2/17,23-26
290	3/4-7	GRANT(8719)	5/24-27
390	3/4-7	HONEST ABE	1/60
480	3/8-15	JOHN Q	1/60
	5/39	MCKINLEY	4/12,13
485	3/8-15	TEDDY R.	1/60
800	3/4-7	WASHINGTON	1/22,23,59
1000	3/8-15	ZACHARY T	1/60
COURIER CENTURION PLL	1/31,61,		
	62,5/55	RCA 14T302	5/11,39
GALAXY	5/53,54,	14T302(PLL 02AG)	4/36
	7/18-22	REALISTIC TRC-431	7/23,24
GLADIATOR PLL	1/31,61,	ROBYN WV-23	1/24,25
	62,5/55	GT-440D	1/23
SPARTAN	1/61,62,	SB-505	5/41,42
	5/30,53,55	SB-520D	2/21,22
CPI 2000	3/25	SB-540D	5/19,36,
2500	5/37,38		7/25-38
		ROYCE 1-601	1/26
DAK IX	5/21,23	612	5/45
X	4/39-46		
DEMCO STAR II	5/60	SBE FORMULA D	1/49
SUPER SATELLITE II	5/60	TOUCH COM	1/50,51
		39CB Sidebander V	2/36,37
GEMTRONIX GTX 77	5/39	SIDEBANDER II	2/28-35
		CONSOLE IV	2/28-35

10 METER CONVERSIONS (CONT'D)

<u>RADIO</u>	<u>VOL/PG</u>	<u>RADIO</u>	<u>VOL/PG</u>
SBE CONSOLE V	2/38-37	TEABERRY T BEAR	4/14, 15
LCBS-4	7/29-33	T DISPATCH	4/14, 15
LCMS-4	7/34-37	TITAN T	4/14, 15
SEARS 934-38260700	6/26, 27	TRAM D42	4/47, 5/40
934-38270700	5/28, 29	D60	1/53
SILTRONIX 1011C	1/46	D201	1/56, 3/22, 23
1011D	1/46	TRS CHALLENGER 460	4/28
SONAR FS-2340	5/31	600	4/28
STANDARD HORIZON 29A	5/58	730	4/30
STONER PRO-40	4/52, 53	1200	4/31
SWAN SIGNET 270	5/58	850/1400	4/21-27, 32-35
TEABERRY	1/43, 5/30	VICTOR 770	4/56, 57
MODEL T	4/3, 4	790	4/58, 59
RACER T	1/58		
RANGER T	4/1, 2,	YAESU 100	5/58
	6/24, 25	FT-901	6/3-12
STALKER I(4001/4002)	4/7-9	FT-7B	7/38-41

SLIDE MODIFICATIONS

<u>RADIO</u>	<u>VOL/PG</u>	<u>RADIO</u>	<u>VOL/PG</u>
BOMAN 950	4/49	JOHNSON 352	1/34
COBRA 132-A	1/28	MIDLAND 13-893	4/51
135-A	1/28	13-898	1/36
135-B	1/29	13-898B	1/35
138	1/28	79-960	5/47
139	1/30		
140GTL	4/50	PACE 1000	1/37, 38
142GTL	4/50	DX1023B	1/39
COLT 485	4/49	8092	6/37
COURIER CENTURION	1/61	PALOMAR 500	4/19, 5/32, 35
GALAXY	5/53	PEARCE BENGAL	1/40
GLADIATOR PLL	1/61	CHEETAH	1/40
SPARTAN	1/61	SIMBA	1/40
CPI 2500	5/37	PRESIDENT ADAMS	2/16
		GRANT	1/59
DAK X	4/45	MCKINLEY	4/12
		WASHINGTON	1/59
GEMTRONICS GTX-77	4/49		
		RCA 14T302	4/49
HYGAIN 623	1/33	REALISTIC TRC-47	1/41
674-A	4/60	TRC-48	1/42

SLIDE MODIFICATIONS (CONT'D)

<u>RADIO</u>	<u>VOL/PG</u>	<u>RADIO</u>	<u>VOL/PG</u>
ROBYN SB-505	5/41	SBE SIDEBANDER II	2/28-35
SB-540D	5/19	SIDE BANDER V	2/38-40
ROYCE 1-632	5/14	CONSOLE IV	2/28-35
1-641	4/51	CONSOLE V	2/28-35
			38-40
SBE SIDEBANDER II	1/47	SEARS 934-38270700	5/28
TEABERRY STALKER IX/XV	4/7,8	934-38310700	5/19
TRAM D60	1/52	SILTRONIX SSB	1/45
D201	1/56	STONER PRO-40	4/52,53

SPECIFIC RADIO TUNEUPS

<u>RADIO</u>	<u>VOL/PG</u>	<u>RADIO</u>	<u>VOL/PG</u>
AIR COMMAND CB-640	5/38	COBRA 78XLR	4/49,6/19
ALARON B-5200	3/41	86XLR	3/45
AUDIOVOX MCB750	3/41	87GTL	6/19
MDV6000	6/18	89GTL	6/18
AUTOMATIC CBH2265	3/41	132XLR	3/45
		135XLR	3/45,4/38
BOMAN CB555	3/44	139	1/20
CB750	2/43	140GTL	3/20,58,4/50
CBH900	3/44	142GTL	4/50
CB910	1/21,3/44	148GTL	6/19
CB920	1/21	1000GTL	6/18
CB930	1/21,3/44	COLT 222	6/20
CB950	3/43	290	3/40
CBR9600	2/42,3/41	390	3/4
CBR9940	3/44	480	3/8,58
		485	3/8,6/19
CHANNEL MASTER CB6835	6/18	800	3/4
CHRYSLER 4048076/8077	6/18	1000	3/8,58
CLARION DMA066	3/45	COMMANDO 2340	1/21
JC202E	3/45	CONVOY Con-400	3/58
RCJ003	3/45	COURIER BLAZER 40D	3/58
TC203E	6/18	CLASSIC PLL40	3/43
COBRA 19	7/51	FANFARE 125F	3/43
21GTL	3/41,58	FANON ROGUE 40	3/43
21XLR	1/20	NIGHTRIDER 40DR	3/46
25GTL	3/41,58	RANGLER 40D	3/58
29GTL	3/45	REDBALL	1/21
29XLR	1/20	RENEGADE 40	3/46
32XLR	3/58	CRAIG L101	6/20
46XLR	3/43	L102	6/20
47XLR	3/45		
50XLR	3/43	DELCO 70BFMC3	2/43
55XLR	3/43	80BCB2	6/20

SPECIFIC RADIO TUNEUPS (CONT'D)

<u>RADIO</u>	<u>VOL/PG</u>	<u>RADIO</u>	<u>VOL/PG</u>
FANON 10-40	6/20	KRACO KCB-2340	2/42
FANFARE 182F	3/41	KCB-4003	3/42
FANFARE 184DF	3/47	KCB-4020	3/49
FANFARE 185PLL	3/46	KCB-4088	3/50
FANFARE 190DF	3/47, 7/51	KRIS XL25	2/43
FANFARE 350F	3/47		
GE 3-5800A	3/50	LAFAYETTE HB640	2/43
3-5804B	6/21	TELESTAT 1240	5/14
3-5814B	6/21		
3-5817A	7/51	MEDALLION 63-240	3/50
3-5818A	2/42	MIDLAND 150M	7/52
3-5821B	3/54	13-893	4/51
3-5830	3/42	76-858	3/49
3-5869A	2/42	76-863	3/50
3-5871B	3/46	77-821	3/42
GEMTRONICS GT44	2/42	77-849	3/50
GT55	3/48	77-861	3/50
GTX66	6/21	77-963	3/42
GTX77	6/21	79-892	3/49
GTX4040	3/48	79-893	2/20
GTX5000	3/42	4001 (77-004)	7/52
GM CBD-203	3/48	MOPAR 4094173	3/51
4120	3/46	4094176	3/51
4175	3/46	4094177	3/49
		4094178	3/60
		MOTOROLA T4000A/05A/10A	
		20A	3/50
HYGAIN VIII	3/59		
674A	4/60	NDI PC-200	7/52
V674B	1/21		
2701	2/42	PACE 8008	2/43
2702	3/48	8193	7/52
2703	3/48	PALOMAR 49	3/60
ITT 4400M	4/17	500	4/19, 5/32
		4100	3/54
JOHNSON 123A	1/21	PEARCE SIMPSON LEOPARD B	3/49
VIKING 260/270	3/49	SUPERTIGER 40A	3/60
MESSENGER 50	7/51	PRESIDENT ADAMS	2/16
MESSENGER 80(242-0080)	7/51	WASHINGTON	1/22
MESSENGER 4120	3/47	JAMES K	7/53
MESSENGER 4135	3/48		
MESSENGER 4140145	3/54	RCA 14T300	2/43
MESSENGER 4170/75	3/47	14T302	3/53
MESSENGER 4250	3/48	REALISTIC TRC-45A	4/37
		TRC-47	1/21
		TRC-57	1/21
		TRC-100	4/37

SPECIFIC RADIO TUNEUPS (CONT'D)

<u>RADIO</u>	<u>VOL/PG</u>	<u>RADIO</u>	<u>VOL/PG</u>
REALISTIC TRC-99A	4/37	SEARS CM-6000LA	3/59
TRC-180	4/37	CM-6000LC	3/59
TRC-200	4/37	Roadtalk 40	2/43
TRC-424	3/57	370-38050700	3/54
TRC-425	7/53	562-38200700	3/55
TRC-431	4/37	663-38020800	7/53
TRC-448	3/51	663-38070700	3/61
TRC-449	3/51	934-38120700	3/61
TRC-452	1/21, 3/52	934-38260700	7/53
TRC-455	3/60	934-38270700	7/54
TRC-461	3/51	934-38310700	7/54, 55
TRC-466	3/51	SHAKESPEARE GBS240	3/53
TRC-468	3/57	SHARP CB-800	2/42
TRC-480	7/53	CB-4670	7/55
ROBYN WV110	3/56	SONAR FS-2340	5/31
LB120	3/52	SPARKOMATIC SR42/CBM	3/54
DG130D	3/56	SURVEYOR 2610	3/54
007-140	3/52	2620	3/55
T-240D	3/56		
SX-401	3/57	TEABERRY MODEL T	3/55
SX-402D	3/57	COMMAND	3/55
GT-410D	3/57	T DISPATCH	3/55
AM500D	3/52	RACER T	3/55
SB-505	5/42	STALKER II	1/21
SB-520D	2/22	STALKER III	7/55
ROYCE 604	3/56	STALKER V	7/55
1-617	3/52	STALKER XII	7/56
1-619	3/56	TRAM D12	3/54
1-621	3/57	TRUE'TONE CYJ4832-A-87	2/43
1-625	3/56	CYJ4837-A-87	3/59
1-641	3/60, 4/51	TRS CHALLENGER 850	7/55
1-651	7/55		
1-660	2/42	UTAC TRX-400	3/59
1-673	3/52	TRX-500	3/56
1-675	3/53		
1-680	3/52	VECTOR X	2/43
SBE 26CB1A	3/61	WARDS GEN-775A	3/61
42CB CORTEZ 40	3/61		
45CB TRINIDAD III	3/61		
47CB	3/53		
49CB TAHOE 40	3/53		
43CB	3/53		

SECRET CB INDEX CONTINUED:

VOLUME 1

	<u>PAGE #</u>
CRYSTAL CROSS REFERENCE GUIDE	5-10
LETTER CHART FOR CRYSTAL FREQUENCY CORRELATION	11-18
GENERAL INFORMATION	63-67
LINEARS	68-70
40 CHANNEL PLL SWITCH	71,72

VOLUME 2

NEW CRYSTAL CROSS REFERENCE GUIDE	5-9
LETTER CHART FOR CRYSTAL FREQUENCY CORRELATION	10-13
ANTENNA REPORTS	53-55
BETA-COM INFO (upgrading 23 channel radios)	57-87

VOLUME 3

SUPER MOD. IV (Frequency counter kit)	16-18
MICROPHONE WIRING INSTRUCTIONS	26-32
PLL CHANNELIZER	33-40
ANTENNA SECRETS (K40 Stud Mount for Big Stick)	63,64
SPECIAL SECTION ON LINEAR AMPLIFIERS:	
50-70W MOBILE	66
300-400W BASE	67-69
70W BASE	70,71
EAGLE 200	72
EAGLE 500	73
CONVERSION FROM AMATEUR TRANSMITTER TO LINEAR AMP	74
LINEAR AMP PROBLEMS & SOLUTIONS	75,76

VOLUME 4

HOW TO BUILD YOUR OWN RELAY MODULE	16
02A CHIP INFORMATION	54,55
TURNER MIC EXPANDER (500 AMC DISABLE)	62
K40 BLINKIE	63
SUNSPOT PREDICTION CHART	64
LINEAR REPORT SECTION	
D & A MAVERICK	65
D & A 500 TRIPLE CONVERSION	65
EAGLE 515 MODIFICATION	66,67
UNIDEN SSB 10 METER POWER CONVERSION	68-70
SUPER CLARIFIER DIODE	71

VOLUME 5

10 METER CONVERSION MICROCOMPUTER (MICROMONITOR PLL)	1-5
ECHO BOX	6
250 WATT DUMMY LOAD	7
BUILT IN POWER MIKE	8,9
5-MILE SIMULATOR	10

SECRET CB INDEX CONTINUED:VOLUME 5 CONTINUED

	<u>PAGE #</u>
RECEIVER PREAMP	11
GLEN DIGITAL CONTROLLER	12, 13
GETTING SWR DOWN ON BASE ANTENNAS	15
APARTMENT ANTENNA	16
GROUNDING MOBILE RADIOS	17
OOPS! WE GOOFED (corrections for volumes 1-4)	17, 18
THE ART OF WIDEBANDING (858 chip)	44
CONVERSION KIT + MARS & CAP FOR SSB	48, 49
CONVERSION OF AM/SSB TO 10 METER AMATEUR	52
REDCO UFO INSTALLATIONS	61-70
SLIDE INCREASE, ALL SSB RADIOS	71
RADAR COMMUNICATOR	71

VOLUME 6

PLL CRYSTAL CROSS REFERENCE GUIDE	1, 2
SECRET CB TEST TONE	13
ERRONEOUS SIGNAL LOCATOR	14
LOW COST AMATEUR CONVERSION FOR 10 METERS	15
BASE ANTENNA GROUNDING	16, 17
SUPER CLARIFIER 10-TURN POT	22
OOPS! WE GOOFED (corrections for volume 5)	25
THUMBWHEEL 200 CHANNEL CONVERSION FOR 858 CHASSIS	31-34
REDCO UFO APPLICATIONS	40-52
SPECIAL SECTION ON LINEAR AMPLIFIERS	
PDX 400	54
D & A MAVERICK 250	55
MACO DUSTER 300, 750 & 1000 TRANSMITTER	56
MACO 75	56, 57
500 CX & 700CX 10 to LL METER CONVERSIONS	58
RDX-75	59
HDX-50	59
MDX-200	60
PDX-400 LINEAR AMPLIFIER	61
10 METER EXPERIMENTER BOARD INFORMATION	62, 63
SUPER CLARIFIER HINTS	66
REDCO DX-50	68-70

VOLUME 7

HOW TO MAKE YOUR EAGLE SCREAM	14
IMPROVED SLIDE MODIFICATION FOR 02A SSB RADIOS	42
UPDATED 200 CHANNEL AMATEUR CONVERSION FOR 858 CHIP	43-48
10 METER CONVERSION FOR SSB RADIOS USING MB8719 CHIP	49-50
HOW TO MAKE YOUR 858 CHASSIS SLIDE	56
LINEAR AMPLIFIER NOTES	57-59
ECHO BOX SPEECH PROCESSING FOR TRC-449	60
ADDING PING	61

SECRET CB INDEX CONTINUED:

VOLUME 7 CONTINUED

	<u>PAGE #</u>
CORRECTION TO THUMBWHEEL 200 CHANNEL CONVERSION	62,63
MICROMONITOR TECH NOTES	64-69
MICROMONITOR INSTALLATION INSTRUCTIONS FOR RADIOS USING 858 CHIP	70,71
AMP FOR RF PROBE	72
OSCILLOSCOPE MODIFICATION FOR RF AND MODULATION DISPLAY	73
THE "BANDIT" ANTENNA	74-76
EXPO 100 KIT	76
SECRET CB's OWN "TROUBLESHOOTER"	77

THIS SPACE FOR YOUR PERSONAL NOTES:

NEW PRODUCT RELEASE

AMATEUR VSB-1 (VOICE SIGNAL BOOSTER)

Ever hear the old saying that to get a mule's attention you have to hit him between the eyes with a 2 x 4 first? That pretty much says it all for those who want to shoot skip nowadays. QRM is so bad that even if a station clear across country hears your call he won't reply if you're not strong enough to step on those stations closer to him. If he's going to QSO, the man on the other end wants to be able to finish it without losing you in the middle of it. Well, we can now furnish you with the 2 x 4 you need to get his attention and keep it legally, without having to put up expensive beam arrays or using linear amps.

The VSB-1 module combines two voice processing innovations to give you talk-power comparable to the most expensive rigs on the market. We've been asked if it increases modulation. Not on your life! *You don't need it!* The VSB-1 module will give you more talk power than any power mike on the market! Skeptical? Listen to a Stoner Pro-10 sometime. One of its finest features is Voice Bandwidth Compression (VBC), which uses the same principle of speech processing as your VSB-1. I haven't met too many people who wouldn't want to own a Stoner Pro-10, but not many are willing to pay the price. Now, any cheap radio can sound like one!

Secret CB has taken speech processing a step farther — processed speech on receive as well as on transmit! Let's look at how it affects the transmitted voice first.

On transmit, the VSB-1 module compresses the voice bandwidth down to a fraction of its normal size. This makes the transmitted voice signal stronger and clearer, without having to increase modulation. You will get through QRM clearer than anyone else on the air.

The benefits you'll realize from the VSB-1 are much more noticeable and impressive in the way it improves received signals. It takes a weak signal and expands it to an intelligible level while leaving the noise level the same. You get as much as 2:1 signal to noise improvement! For example: When you turn the radio on you will have the VSB-1 expander switched off. Adjust the volume control to a comfortable listening level. Suddenly you hear an acquaintance on the air but can't hear him very well. You turn the volume up, but this increases the noise too, so you still have trouble hearing him. Now is when you switch in the VSB-1 expander. What happens? He's now coming across loud and clear and the noise level is reduced considerably! You may even have to turn the volume down! You'll be able to QSO when no one else can!

The VSB-1 will mount inside the radio in just a matter of minutes. Even if no one else has one, you will still realize a tremendous improvement in your rig's performance. It will work in any rig, be it AM, SSB, FM, or Ham! Your cost is \$42.50, and you'll never have to take a back seat to anyone again when it comes to shooting skip!

SECRET CB[®]

