

# SECRET CB<sup>®</sup>

Special  
Index  
Issue



CONFIDENTIAL  
**FACTUAL  
REPORT**  
SCHEMATICS ETC.  
UPDATED QUARTERLY



## **IMPORTANT: READ THIS FIRST**

The information in this book is not to be used to exceed F.C.C. specifications, in any case, as applied to power, modulation, frequency spectrum, etc. It is illegal to do this to any CLASS D RADIO.

This book is a factual report of gathered information, and as such is intended for use on radios for EXPORT ONLY.

If you are not familiar with electronics, it is better to check for advice with your local electronics or CB center, as to restrictions, etc., concerning your radio.

More information, on other units will be forthcoming in future issues, to be published on a quarterly basis.

This book will not be found at a book store, but can be obtained through your local CB Dealer or Distributor, or by completing the order form in the book and sending to:

Selman Enterprises, Inc.  
P.O. Box 8189  
Corpus Christi, Texas 78412

Secret CB  
Volume Seven  
Published January, 1980

Copyright 1980. All rights reserved in the United States and most foreign countries.

New issues quarterly

Address any and all inquiries to:

Selman Enterprises, Inc.  
P.O. Box 8189  
Corpus Christi, Texas 78412

(512) 992-1303

## -INTRODUCTION-

### LET'S TALK ABOUT CLARIFIERS

Clarifiers can "eat your lunch", so to speak, if you are not familiar with their operation. One of the typical problems with clarifiers is that after the modification...RX and TX are split or they are simply off frequency from one another. This is one reason we developed the "Trouble Shooter". "The Troubleshooter" can spot distortion on sideband, align clarifiers, check for frequency splits, align S-meters and check for 5 and 20 mile range, and also tunes SSB sets with its handy two-tone oscillator. We figure that some of us have nice scopes and sophisticated test equipment, but also that most of us don't. Just about everyone has a known good CB around and a pair of stereo headphones! This is a dynamic test instrument that can enhance your shack or shop. What a way to show a non-SSB'er how to use a sideband without getting on the air!

Back to the theory behind making a set clarify: you simply vary the voltage on the varactor or super diode. What happens is that the set varies the voltage in receive, but when you transmit, voltage in that circuit controlling voltage goes to zero. You have to provide a constant voltage to that point and vary the voltage to the varactor with your clarifier pot.

The ten turn pot will give you more room to play with on the clarifier control when using more slide capabilities.

BEWARE OF INADEQUATE VOLTAGE TO THE SIDEBAND. AN IMPROPER NOISE FILTER, AN INSUFFICIENT POWER SUPPLY CAN CAUSE A FREQUENCY SPLIT ON YOUR SIDEBAND.

Case in point was a person having all kinds of problems with distortion, off frequency, etc. Problem was a low amperage noise filter too small to handle the power of the sideband in transmit. When voltage was checked inside the car behind the noise filter we found the AM to be OK. But when sideband was keyed up, voltage went from 13.8 volts to 11.2 volts. Removing the noise filter cured the problem. I hope this helps one of you sometime and enhances your knowledge if you are unaware of this problem.

GOOD LUCK!

73's   
Rodney E. Johnson



## 10 METER CONVERSIONS CONTINUED:

<u>RADIO</u>	<u>VOL/PG.</u>	<u>RADIO</u>	<u>VOL/PG.</u>
Stoner Pro-40	4/52,53	Tram D201	1/56,3/22,23
Swan Signet 270	5/58		4/48
Teaberry	1/43,5/30	TRS Challenger 460	4/28
Model T	4/3,4	600	4/28
Racer T	1/58	730	4/30
Ranger T	4/1,2,6/24,25	1200	4/31
Stalker I	1/57,4/56	850/1400	4/21-27,32-35
Stalker I(4001/4002)	4/7-9	Victor 770	4/56,57
T Bear	4/14,15	790	4/58,59
T Dispatch	4/14,15	Yaesu 100	5/58
Titan T	4/14,15	FT-901	6/3-12
Tram D42	4/47,5/40		
Tram D60	1/53		

## SLIDER MODIFICATIONS:

<u>RADIO</u>	<u>VOL/PG.</u>	<u>RADIO</u>	<u>VOL/PG.</u>
Boman 950	4/49	Pace 1000	1/37,38
Cobra 132-A	1/28	Pace DX1023B	1/39
135-A	1/28	Pace 8092	6/37
135-B	1/29	Palomar 500	4/19,5/32,35
138	1/28	Pearce Bengal	1/40
139	1/30	Pearce Cheetah	1/40
140 GTL	4/50	Pearce Simba	1/40
142 GTL	4/50	President Adams	2/16
Colt 485	4/49	President Grant	1/59
Courier Centurion	1/61	President McKinley	4/12
Courier Galaxy	5/53	President Washington	1/59
Courier Gladiator PLL	1/61		
Courier Spartan	1/61	RCA 14+302	4/49
CPI 2500	5/37	Realistic TRC-47	1/41
Dak X	4/45	TRC-48	1/42
Gemtronics GTX-77	4/49	Robyn SB-505	5/41
Hygain 623	1/33	Robyn SB-540D	5/19
Hygain 674-A	4/60	Royce 1-632	5/14
Johnson 352	1/34	Royce 1-641	4/51
Midland 13-893	4/51	SBE Sidebander II	1/47
Midland 13-898	1/36	SBE Sidebander II	2/28-35
Midland 13-898B	1/35	SBE Sidebander V	2/38-40
Midland 79-960	5/47	SBE Console IV	2/28-35
		SBE Console V	2/28-35,38-40
		Sears SSB	1/44
		Sears 934-38270700	5/28
		Sears 934-38310701	5/19
		Siltronix SSB	1/45
		Stoner Pro-40	4/52,53



SLIDER MODIFICATIONS CONTINUED:

<u>RADIO</u>	<u>VOL/PG.</u>	<u>RADIO</u>	<u>VOL/PG.</u>
Teaberry Stalker IX/XV	4/7,8		
Tram D60	1/52		
Tram D201 (Transmit)	1/56		

\*\*\*\*\*

SPECIFIC RADIO TUNEUPS:

<u>RADIO</u>	<u>VOL/PG.</u>	<u>RADIO</u>	<u>VOL/PG.</u>
Air Command CB-640	5/38	Cobra 142GTL	4/50
Alaron B-5200	3/41	148GTL	6/19
Audiovox MCB750	3/41	1000GTL	6/18
MDV6000	6/18	Colt 222	6/20
Automatic CBH2265	3/41	290	3/40
		390	3/4
Boman CB555	3/44	480	3/8,58
CB750	2/43	485	3/8,6/19
CBH900	3/44	800	3/4
CB910	1/21,3/44	1000	3/8,58
CB920	1/21	Commando 2340	1/21
CB930	1/21,3/44	Convoy Con-400	3/58
CB950	3/43	Courier Blazer 40D	3/58
CBR9600	2/42,3/41	Classic PLL40	3/43
CBR9940	3/44	Fanfare 125F	3/43
		Fanon Rogue 40	3/43
Channel Master CB6835	6/18	Nightrider 40DR	3/46
Chrysler 4048076/8077	6/18	Rangler 40D	3/58
Clarion DMA066	3/45	Redball	1/21
JC202E	3/45	Renegade 40	3/46
RCJ003	3/45	Craig L101	6/20
TC-203E	6/18	L102	6/20
Cobra 21GTL	3/41,58	Delco 70BFMC3	2/43
21XLR	1/20	80BCB2	6/20
25GTL	3/41,58		
29GTL	3/45	Fanon 10-40	6/20
29XLR	1/20	Fanfare 182F	3/41
32XLR	3/58	Fanfare 184DF	3/47
46XLR	3/43	Fanfare 185PLL	3/46
47XLR	3/45	Fanfare 190DF	3/47
50XLR	3/43	Fanfare 350F	3/47
55XLR	3/43		
78XLR	4/49,6/19	G.E. 3-5800A	3/50
86XLR	3/45	3-5804B	6/21
87GTL	6/19	3-5814B	6/21
89GTL	6/18	3-5818A	2/42
132XLR	3/45	3-5821B	3/54
135XLR	3/45,4/38	3-5830	3/42
139	1/20	3-5869A	2/42
140GTL	3/20,58,4/50	3-5871B	3/46



SPECIFIC RADIO TUNEUPS CONTINUED:

<u>RADIO</u>	<u>VOL/PG.</u>	<u>RADIO</u>	<u>VOL/PG.</u>
Gemtronics GT44	2/42	Mopar 4094176	3/51
GT55	3/48	4094177	3/49
GTX-66	6/21	4094178	3/60
GTX-77	6/21	Motorola T4000A/05A/	3/50
GTX-4040	3/48	10A/20A	3/50
GTX-5000	3/42		
G.M. CBD-203	3/48	Pace 8008	2/43
4120	3/46	Palomar 49	3/60
4175	3/46	500	4/19, 5/32
		4100	3/54
Hygain VIII	3/59	Pearce Simpson Leopard B	3/49
674A	4/60	Supertiger 40A	3/60
V-674B	1/21	President Adams	2/16
2701	2/42	Washington	1/22
2702	3/48		
2703	3/48	RCA 14T300	2/43
		14T302	3/53
ITT 4400M	4/17	Realistic TRC-45A	4/37
		TRC-47	1/21
Johnson 123A	1/21	TRC57	1/21
Viking 260/270	3/49	TRC-100	4/37
Messenger 4120	3/47	TRC99A	4/37
Messenger 4135	3/48	TRC-180	4/37
Messenger 4140/145	3/54	TRC-200	4/37
4170/75	3/47	TRC-424	3/57
Messenger 4250	3/48	TRC-431	4/37
		TRC-448	3/51
Kraco KCB-2340	2/42	TRC-449	3/51
KCB-4003	3/42	TRC-452	1/21, 3/52
KCB-4020	3/49	TRC-455	3/60
KCB-4088	3/50	TRC-461	3/51
Kris XL25	2/43	TRC-466	3/51
		TRC-468	3/57
Lafayette HB640	2/43	Robyn WV110	3/56
Telestat 1240	5/14	LB120	3/52
		DG130D	3/56
Medallion 63-240	3/50	007-140	3/52
Midland 13-893	4/51	T-240D	3/56
76-858	3/49	SX-401	3/57
76-863	3/50	SX-402D	3/57
77-821	3/42	GT-410D	3/57
77-849	3/50	AM500D	3/52
77-861	3/50	SB-505	5/42
77-963	3/42	SB-520D	2/22
79-892	3/49	Royce 604	3/56
79-893	2/20	1-617	3/52
Mopar 4094173	3/51	1-619	3/56



SPECIFIC RADIO TUNEUPS CONTINUED:

<u>RADIO</u>	<u>VOL/PG,</u>	<u>RADIO</u>	<u>VOL/PG</u>
Royce 1-621	3/57		
1-625	3/56		
1-641	3/60, 4/51		
1-660	2/42		
1-673	3/52		
1-675	3/53		
1-680	3/52		
SBE 26CB1A	3/61		
42CB Cortez 40	3/61		
45CB Trinidad III	3/61		
47CB	3/53		
49CB Tahoe 40	3/53		
430B	3/53		
Sears CM-6000LA	3/59		
CM-6000LC	3/59		
Roadtalk 40	2/43		
370-38050700	3/54		
562-38200700	3/55		
663-38070700	3/61		
934-38120700	3/61		
Shakespeare GBS240	3/53		
Sharp CB-800	2/42		
Sonar FS-2340	5/31		
Sparkomatic SR42/CBM	3/54		
Surveyor 2610	3/54		
2620	3/55		
Teaberry Model T	3/55		
Model T Command	3/55		
T Dispatch	3/55		
Racer T	3/55		
Stalker II	1/21		
Tram D12	3/54		
Truetone CYJ4832-A-87	2/43		
CYJ4837-A-87	3/59		
Utac TRX-400	3/59		
TRX-500	3/56		
Vector X	2/43		
Wards GEN-775A	3/61		



SECRET CB INDEX CONTINUED:

<u>VOLUME 1</u>	<u>PAGE #</u>
CRYSTAL CROSS REFERENCE GUIDE	5-10
LETTER CHART FOR CRYSTAL FREQUENCY CORRELATION	11-18
GENERAL INFORMATION	63-67
LINEARS	68-70
40 CHANNEL PLL SWITCH	71,72
<u>VOLUME 2</u>	
NEW CRYSTAL CROSS REFERENCE GUIDE	5-9
LETTER CHART FOR CRYSTAL FREQUENCY CORRELATION	10-13
ANTENNA REPORTS	53-55
BETA-COM INFO (upgrading 23 channel radios)	57-87
<u>VOLUME 3</u>	
SUPER MOD. IV (Frequency counter kit)	16-18
MICROPHONE WIRING INSTRUCTIONS	26-32
PLL CHANNELIZER	33-40
ANTENNA SECRETS (K40 Stud Mount for Big Stick)	63,64
SPECIAL SECTION ON LINEAR AMPLIFIERS:	
50-70W MOBILE	66
300-400W BASE	67-69
70W BASE	70,71
EAGLE 200	72
EAGLE 500	73
CONVERSION FROM AMATEUR TRANSMITTER TO LINEAR AMP.	74
LINEAR AMP. PROBLEMS & SOLUTIONS	75,76
<u>VOLUME 4</u>	
HOW TO BUILD YOUR OWN RELAY MODULE	16
O2A CHIP INFORMATION	54,55
TURNER MIC EXPANDER (500 AMC DISABLE)	62
K40 BLINKIE	63
SUNSPOT PREDICTION CHART	64
LINEAR REPORT SECTION	
D & A MAVERICK	65
D & A 500 TRIPLE CONVERSION	65
EAGLE 515 MODIFICATION	66,67
UNIDEN SSB 10 METER POWER CONVERSION	68-70
SUPER CLARIFIER DIODE	71
<u>VOLUME 5</u>	
10 METER CONVERSION MICROCOMPUTER (MICROMONITOR PLL)	1-5
ECHO BOX	6
250 WATT DUMMY LOAD	7
BUILT IN POWER MIKE	8,9
5-MILE SIMULATOR	10



VOLUME 5 CONTINUED

PAGE #

RECEIVER PREAMP	11
GLEN DIGITAL CONTROLLER	12, 13
GETTING SWR DOWN ON BASE ANTENNAS	15
APARTMENT ANTENNA	16
GROUNDING MOBILE RADIOS	17
OOPS! WE GOOFED (corrections for volumes 1-4)	17, 18
THE ART OF WIDEBANDING (858 chip)	44
CONVERSION KIT +MARS & CAP FOR SSB	48, 49
CONVERSION OF AM/SSB TO 10 METER AMATEUR	52
REDCO UFO INSTALLATIONS	61-70
SLIDE INCREASE, ALL SSB RADIOS	71
RADAR COMMUNICATOR	71

VOLUME 6

PLL CRYSTAL CROSS REFERENCE GUIDE	1, 2
SECRET CB TEST TONE	13
ERRONEOUS SIGNAL LOCATOR	14
LOW COST AMATEUR CONVERSION FOR 10 METERS	15
BASE ANTENNA GROUNDING	16, 17
SUPER CLARIFIER 10-TURN POT	22
OOPS! WE GOOFED (corrections for volume 5)	25
THUMBWHEEL 200 CHANNEL CONVERSION FOR 858 CHASSIS	31-34
REDCO UFO APPLICATIONS	40-52
SPECIAL SECTION ON LINEAR AMPLIFIERS	
PDX 400	54
D & A 250 MAVERICK	55
MACO DUSTER 300, 750 & 1000 Transmitter	56
MACO 75	56, 57
500 CX & 700CX 10 to 11 METER CONVERSIONS	58
RDX-75	59
HDX-50	59
MDX-200	60
PDX-400 LINEAR AMPLIFIER	61
10 METER EXPERIMENTER BOARD INFORMATION	62, 63
SUPER CLARIFIER HINTS	66
REDCO DX-50	68-70



# BROWNING MKIV TRANSMITTER FØ CONVERSION

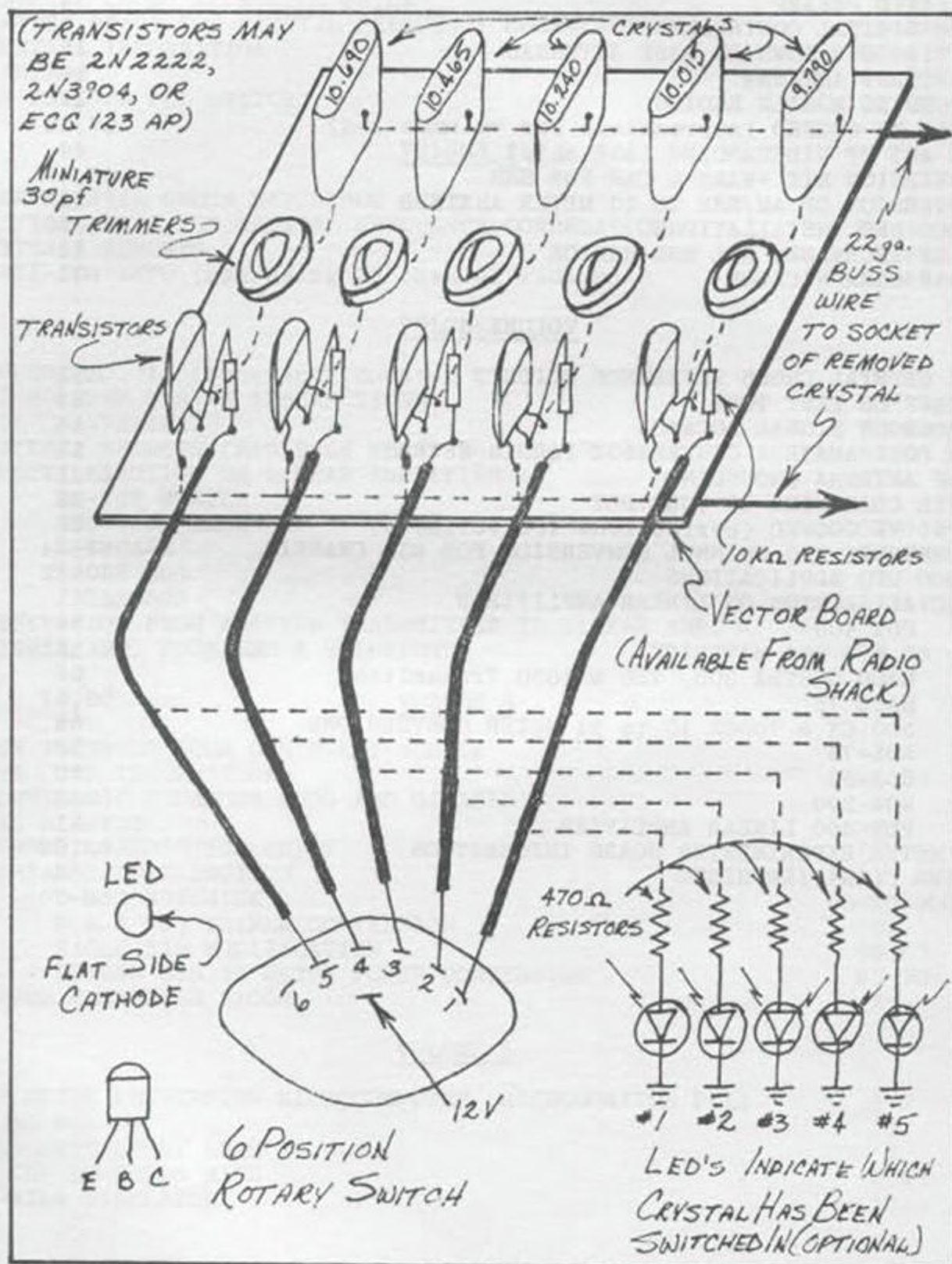



## BROWNING MKIV TRANSMITTER FØ CONVERSION CONT.:

A kit may be made as shown to switch the 10.240 MHz xtal & others in and out of the circuit. The reason for not putting the xtals on a switch is lead length causing all types of problems. Make up a kit as shown, using a piece of vector board.

### PARTS NEEDED:

- 5 1N2222 or GCG132AP or 2N3904 transistors (npn)
- 5 10K ohm  $\frac{1}{4}$ W resistors
- 5 30pf miniature trimmers
- 4 Xtals (must be 30pf, 1st overtone miniature case with wires:
  - 26.075 - 26.505 use 9.790
  - 26.515 - 26.955 use 10.015
  - 26.965 - 27.405 use 10.240 (removed from xtal socket)
  - 27.415 - 27.855 use 10.465
  - 27.865 - 28.305 use 10.690

CAUTION: This must be as small as possible; very compact and mounted as close as possible to the original xtal position on the P/C board. You must use solid wire only for the leads to the xtal socket. Stranded wire is OK leading to the switch.

The trimmer on the P/C board where the stock crystal (10.240) was removed must be jumped (C705), because you will use the new trimmers you install on the vector board for alignment.



# BROWNING MK IV & MK IVA EXPANSION

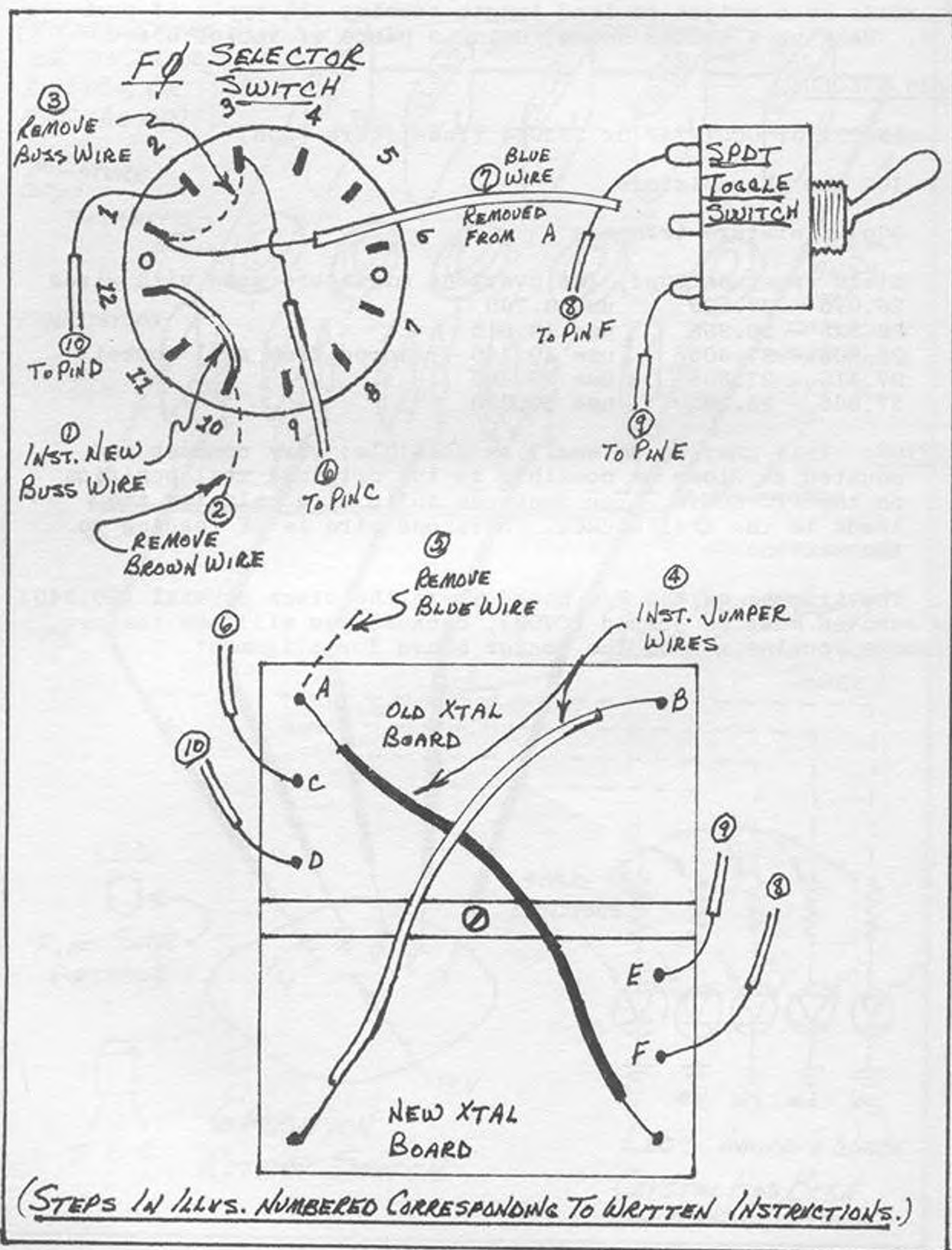



## BROWNING MKIV & MKIVA EXPANSION CONTINUED:

Here is the stuff you have been waiting for on the Golden Eagle. First we will look at the RX expansion:

1. Single pole double throw toggle switch.
2. Browning part #14-0069 crystal board. This will allow you to switch in 2 new receive ranges.
3. You must choose the desired xtals that will give you the receive range. Choose 2 for your new board; crystals available from your favorite xtal supplier.

26.325 MHz to 26.645 MHz	-----	22.180
26.645 MHz to 26.965 MHz	-----	22.500
27.545 MHz to 27.855 MHz	-----	23.390
27.605 MHz to 27.925 MHz	-----	23.460
27.925 MHz to 28.245 MHz	-----	23.780

Mount and wire the new xtal and switch board as shown in drawing. The frequency selector switch will have to be wired as shown. All wiring must be kept short as possible and use solid wire, not stranded on all xtal leads.

Drill a hole in the front panel as close as possible to the F $\emptyset$  selector switch and the crystal board and mount the new toggle switch. It may be labeled with dry transfers as to the new F $\emptyset$  range.

1. Solder a buss wire connecting pins 10,11,12 of the F $\emptyset$  selector switch.
2. Remove the brown wire from Pin #10 and tape back.
3. Remove the buss wire from Pins 1 & 3.
4. Install jumpers from old xtal board to new xtal board as shown.
5. Remove the blue wire from point A, old xtal board.
6. Install a new wire from position 3 of F $\emptyset$  switch to point C on the old xtal board.
7. Connect the blue wire removed in step 5 to the common or center pole of the SPDT toggle switch.
8. Connect a new wire from the top pole of the toggle switch & connect it to point F on the new xtal board.
9. Connect a new wire from the bottom of the toggle switch & connect it to point E on the new xtal board.



BROWNING MKIV & MKIVA EXPANSION CONTINUED:

10. Solder a wire from terminal 2 of the F $\phi$  control switch to point D on the old xtal board.
11. Check all xtals for proper operation. The new F $\phi$  will be on the xtal position of the F $\phi$  selector switch and selectable with the toggle switch. If they do not isolate, adjust L105.

This completes the modification. Remember to use solid wire with xtals and keep all leads short as possible.

TRANSMITTER MODIFICATION

Make up a switch kit as shown and install in a convenient place on your xmitter using a DPDT center off toggle switch.

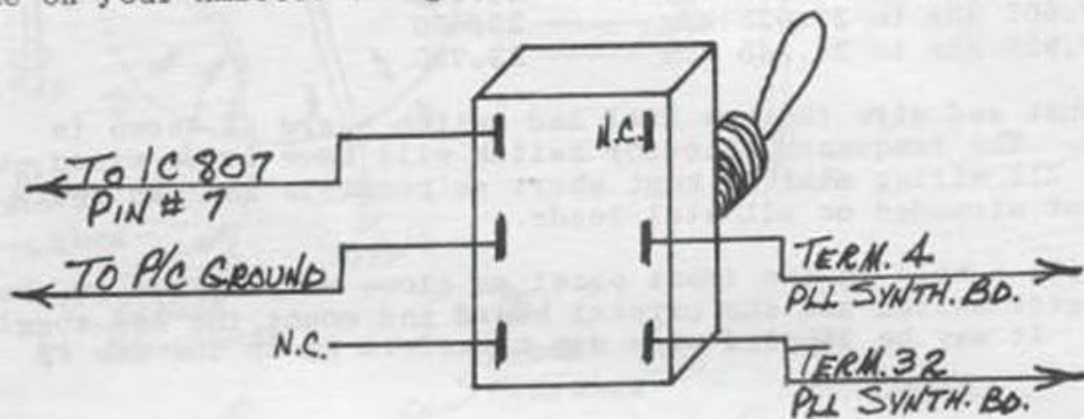

SWITCH IN "UP" POSITION NORMAL CHANNELS

SWITCH IN CENTER POSITION

1.	26.975	11.	27.135	21.	27.295	31.	27.455
2.	26.985	12.	27.145	22.	27.305	32.	27.465
3.	26.995	13.	27.155	23.	27.315	33.	27.475
4.	27.005	14.	27.165	24.	27.325	34.	27.485
5.	27.015	15.	27.175	25.	27.335	35.	27.495
6.	27.025	16.	27.185	26.	27.345	36.	27.505
7.	27.035	17.	27.195	27.	27.355	37.	27.515
8.	27.045	18.	27.205	28.	27.365	38.	27.525
9.	27.055	19.	27.215	29.	27.375	39.	37.535
10.	27.125	20.	27.285	30.	27.445	40.	26.965



BROWNING MKIV & MKIVA EXPANSION CONTINUED:

SWITCH IN THE DOWN POSITION:

1. 26.975	11. 27.135	21. 27.335	31. 27.495
2. 26.985	12. 27.145	22. 27.345	32. 27.505
3. 26.995	13. 27.155	23. 27.355	33. 27.515
4. 27.325	14. 27.485	24. 27.325	34. 27.485
5. 27.335	15. 27.495	25. 27.335	35. 27.495
6. 27.345	16. 27.505	26. 27.345	36. 27.505
7. 27.355	17. 27.515	27. 27.355	37. 27.515
8. 27.045	18. 27.205	28. 27.405	38. 27.565
9. 27.055	19. 27.215	29. 27.415	39. 27.575
10. 27.125	20. 27.325	30. 27.485	40. 26.965

MKIV, IVA TRANSMITTER

Make up and install in a convenient location a switch as shown using a DPDT center off, miniature toggle switch.

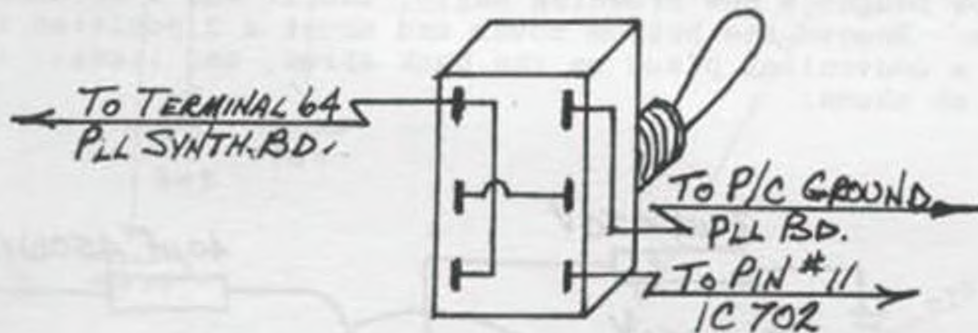

NEW SWITCH IN UP POSITION:

1. 26.965	11. 26.795	21. 26.895	31. 26.995
2. 26.975	12. 26.805	22. 26.905	32. 27.005
3. 26.985	13. 26.815	23. 26.915	33. 27.015
4. 27.005	14. 26.825	24. 26.925	34. 27.025
5. 27.015	15. 26.835	25. 26.935	35. 27.035
6. 27.025	16. 26.845	26. 26.945	36. 27.045
7. 27.035	17. 26.855	27. 26.955	37. 27.055
8. 27.055	18. 26.865	28. 26.965	38. 27.065
9. 27.065	19. 26.875	29. 26.975	39. 27.075
10. 27.075	20. 26.885	30. 26.985	40. 27.405

CENTER NORMAL CHANNELS



# MKIV, IVA TRANSMITTER CONTINUED:

## SWITCH POSITION DOWN:

1.	26.965	11.	27.405	21.	27.535	31.	27.635
2.	26.975	12.	27.425	22.	27.545	32.	27.645
3.	26.985	13.	27.435	23.	27.575	33.	27.655
4.	27.005	14.	27.445	24.	27.555	34.	27.665
5.	27.015	15.	27.455	25.	27.565	35.	27.675
6.	27.025	16.	27.475	26.	27.585	36.	27.685
7.	27.035	17.	27.485	27.	27.595	37.	27.695
8.	27.055	18.	27.495	28.	27.605	38.	27.705
9.	27.065	19.	27.505	29.	27.615	39.	27.715
10.	27.075	20.	27.525	30.	27.625	40.	27.405

## HOW TO MAKE YOUR EAGLE SCREAM

So you bought a new Browning Eagle, and it won't scream. OK, here's how. Remove the bottom cover and mount a 3 position rotary switch in a convenient place on the back apron, and install the new parts as shown:

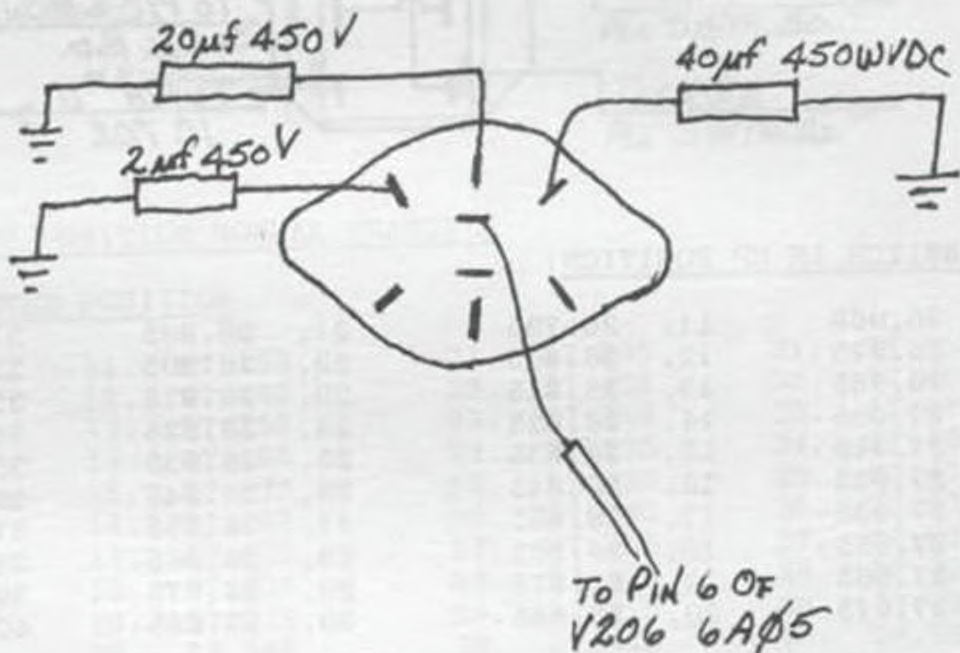

This will allow you two lengths of ping. Be sure to switch back to stock for SSB.



# COBRA 2000 MODIFICATION

Corrected page for this printing.

2 POLE/6 POSITION ROTRARY SWITCH  
3 - 1N914 DIODES

POS	FREQUENCIES
1	26.815-27.005
2	Normal
3	27.415-27.445 (37, 38, 39, 40)
4	27.455-27.725
5	27.605-28.045
6	Normal

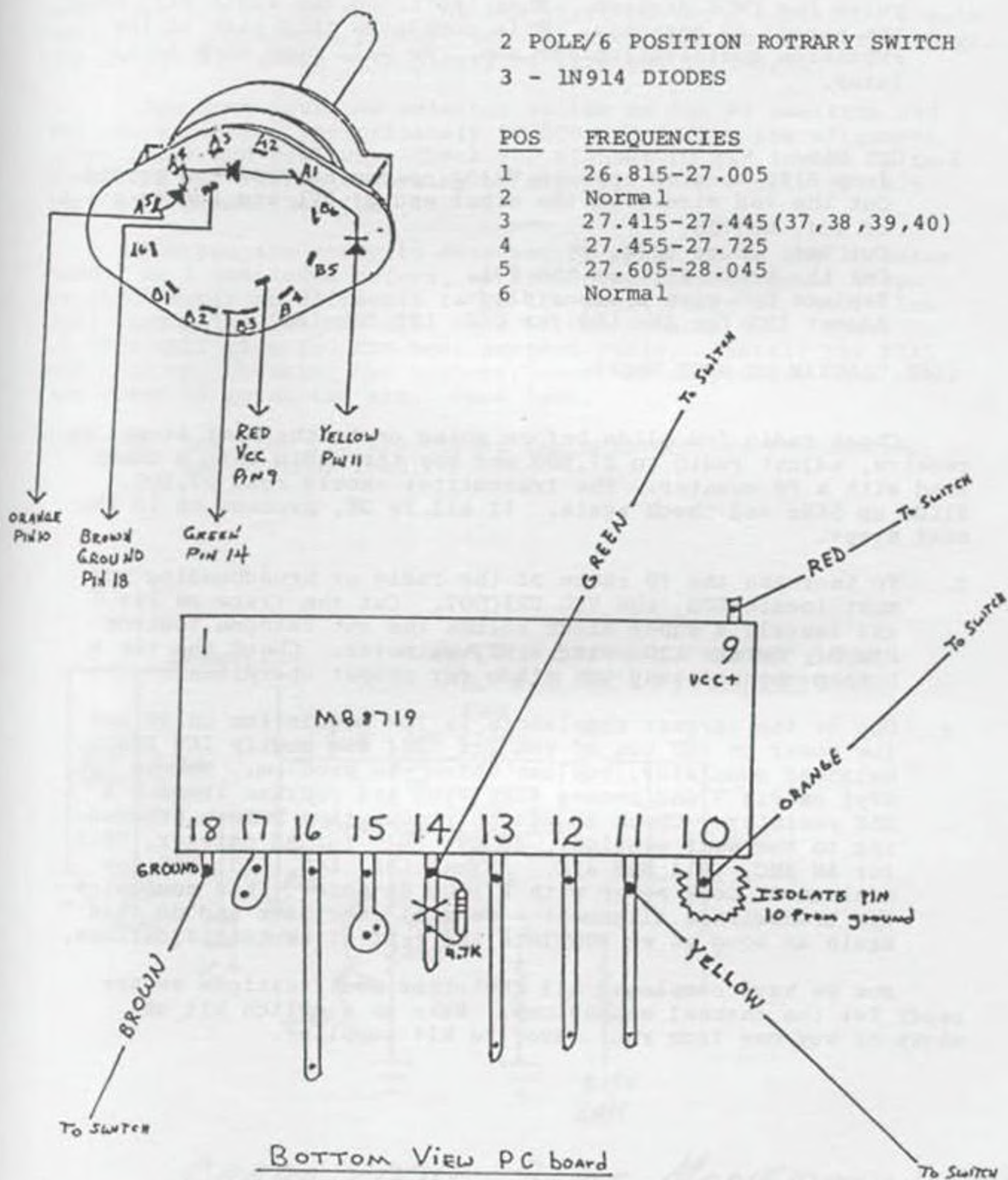



COBRA 2000 CONTINUED:

1. Remove the MB8734 PLL chip using a grounded soldering iron and a wrist strap or touch the radio at all times. Install the white coded chip, taking care to observe all of the rules for CMOS devices. When installed the radio will have the normal 40 channels. This completes this part of the expansion modification for now. We will come back to it later.
2. Cut D52.  
Jump R175 located between VR402 coarse control and ground. Cut the red wire from the other end of FVL and run to pin 1 of IC4, MB3756.  
Cut R44, short R174.  
Cut the brown wire on the FVL.  
Replace D35 with a super diode.  
Adjust L23 for AM; L59 for USB; L22 for LSB.

(SEE DIAGRAM ON NEXT PAGE).

Check radio for slide before going on to the next step. On receive, adjust radio to 27.200 and key the radio into a dummy load with a F $\emptyset$  counter. The transmitter should read 27.200. Slide up 5KHz and check again. If all is OK, proceed on to the next steps.

3. To increase the F $\emptyset$  range of the radio or broadbanding you must locate IC2, the VCO UHIC007. Cut the trace on Pin 6 and install a super diode across the cut cathode towards Pin 6. Retune L20 using a RF voltmeter. Check the top & bottom channels and the slide for proper operation.
4. One of the largest complaints is low modulation on AM and low power on SSB but if you cut TR24 and modify IC3 AN612 balanced modulator, you can solve the problem. Remove the 47pf on Pin 3 and remove R206 270K and replace it with a 35K resistor. Check AM and SSB modulation before proceeding to the next section. Adjust VR10 for AM carrier, VR12 for AM AMC, VR11 SSB ALC. Adjust L38, L42, L45, L46 for maximum AM peak power with a 1000 Hz tone. This completes the transmitter alignment - we will come back and do this again as soon as we complete the rest of the modifications.

Now we have completed all the other modifications we are ready for the channel expansions. Make up a switch kit as shown or buy one from your favorite kit supplier.



## COBRA 2000 CONTINUED

Remove the auxiliary jack from the front panel and tape it up inside the radio. This leaves a convenient hole for you to mount the new switch kit. Cut the shaft on the 6 position, 2 pole switch and install in radio. Install knob and you are ready to go. The switch kit comes with plenty of wire cut to length.

Now move your new selector switch to the #4 position and set the radio for approximately 27,500 and follow the alignment steps above and realign. Check for highest F $\phi$  and lowest F $\phi$  to make sure the radio is working on all F $\phi$ . This completes this part of the modification.

Now you are ready to move the F $\phi$  range up to the 10 meter band. As I mentioned before, we are doing this in small steps because it may be difficult to go the whole range at once. You will need a 11.8391 MHz xtal or a 11.660 or a 11.400. The 11.3891 will give you the best amateur range. Install the xtal and tune up, checking the highest/lowest F $\phi$  as you go. Now you are ready to go on the air. Good luck.

**CAUTION:** Any time you are tuning for unauthorized frequencies, use a dummy load.

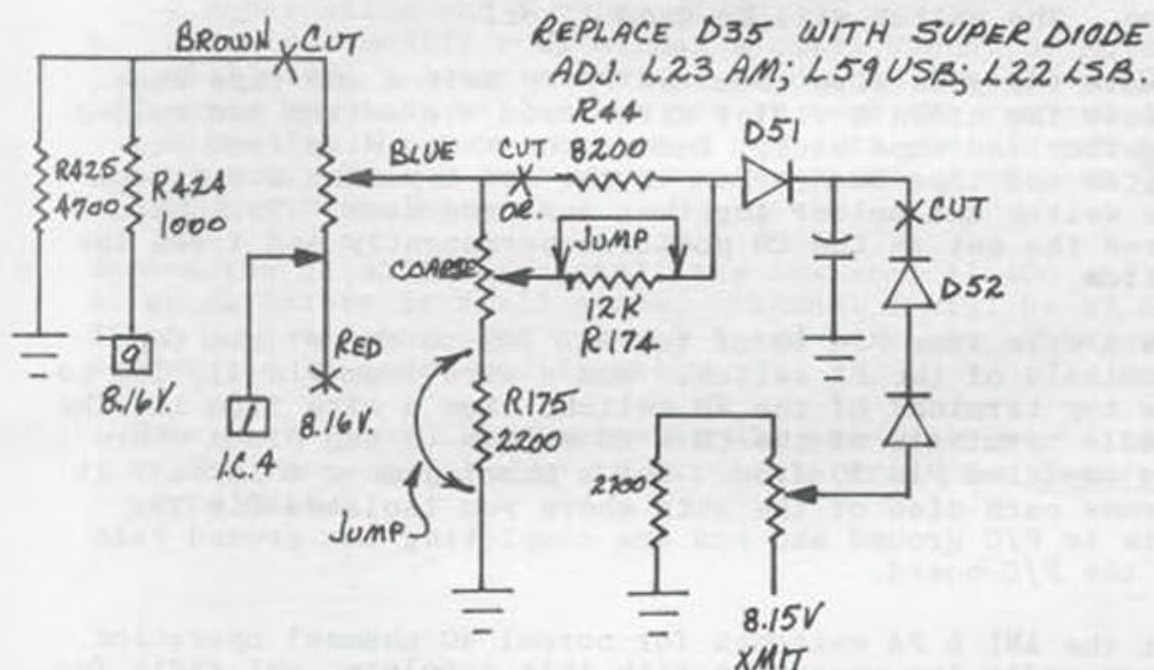

COBRA 2000 SLIDE MODIFICATION



## COURIER GALAXY 10 METER AMATEUR CONVERSION

1. The scope of this conversion is to convert this radio to the amateur 10 meter portion of the band, expand the base channel spread and to change the receive clarifier.
2. Remove the MB8734 PLL chip IC2 from the radio using a grounded temperature controlled soldering iron. Solder wicking or a solder sucker should be used and a minimum amount of heat should be used to avoid damaging the chip. Make sure you and the radio are grounded when you handle the chip. Wrap the old chip in a small piece of aluminum foil and store. Pin 10 must be isolated from ground before installing the new chip in the radio. Inspect the chip side of the P/C board for foil traces or jumpers to ground and cut, if any. Install the new white-coded chip in place of the old chip, observing all necessary safety precautions stated above.
3. A 10 meter switch kit for expanding the channels may be purchased from your Secret CB parts dealer or you may make up your own using the NB/ANL, CB/PA switches in the radio.
4. Remove the red & white wires from the NB switch and tape back separate. Remove the red & orange wires and solder together and tape back. This allows the NB switch to be free for channel expansion, and connects the NB all the time. The switch will be used later.
5. Remove the pink wire from the PA/CB switch and tape back. Remove the brown & violet wires from the switch and solder together and tape back. Remove the white wire from the switch and tape back. Remove the red & yellow wires from the switch and solder together and tape back. This hard-wires the set in the CB position permanently and frees the switch.
6. Run a wire from Pin 10 of the PLL IC2 to one of the top terminals of the PA switch. Run a wire from Pin 11, IC2 to the top terminal of the NB switch. Run a wire from all the middle terminals of the CB & NB switch to the place where you isolated Pin 10 from. Cut a short jumper & install it across each side of the cuts where you isolated Pin 10. This is P/C ground and you are completing the ground path of the P/C board.
7. Set the ANL & PA switches for normal 40 channel operation. Check radio for operation; with this complete, set radio for highest F $\phi$  available and align xmitter & VCO adj. L-19 for



output and do this in small stages, because you can get the radio out of alignment and it will not work at all. Keep moving up in F $\emptyset$  until you can xmit on all F $\emptyset$ , by adjusting L-19. Align xmitter stages L-26, L-27, L-28, L-29, L-36 for maximum with a watt meter and 50 ohm dummy load. Do not do this on the air as these F $\emptyset$  are not allowed for amateur except above 28.000, and also it is discourteous to other operators.

#### 8. SLIDER MODIFICATION

- a. Remove the case from the radio and look at the clarifier control 20 K pot VR402.
  - b. Remove the red wire that runs from the clarifier control to the P/C board at the P/c board and solder it to ground.
  - c. Remove the orange wire that runs from clarifier control to P/C board at the control and tape back. Run a new orange wire from the place where you removed the old wire to pin #1 of IC-5.
  - d. Clip R-187
  - e. Clip D-36. This completes your basic slide modification and will allow +1 & -3 KHz.
  - f. For more slide, remove Ct-3 20 pf trimmer. This will allow +3/-3 KHz, but the clarifier will no longer center. You must remove the knob and recenter it.
  - g. For more slide - approximately +10/-10, replace D37 with a super diode (available from your Secret CB parts dealer), or for maximum slide, approximately 20 KHz, use a super slide and a super diode.
  - h. After you modify your slider a small amount of movement will cause a large amount of slide, so install a 10-turn super pot that will allow you to turn the control 10 times for the same range you had with the old pot you replaced. The 10 turn pots are available from your Secret CB parts dealer.
9. Remove the 11.3258 and install the new xtal 11.400 and align as before in small steps. Channel 1 will be 27.825. Start your alignment at channel 1 and work up. This completes the 10 meter modification.

NOTE: This conversion kit, including all necessary parts, and/or the white coded chip is available from your Secret CB parts dealer.



# COURIER GALAXY

## CHANNEL MODIFICATION WITH HOOKUP ON NOISE BLANKER AND P.A. SWITCHES

NOTE: Color code of wire is for convenience. Any color wire may be used.

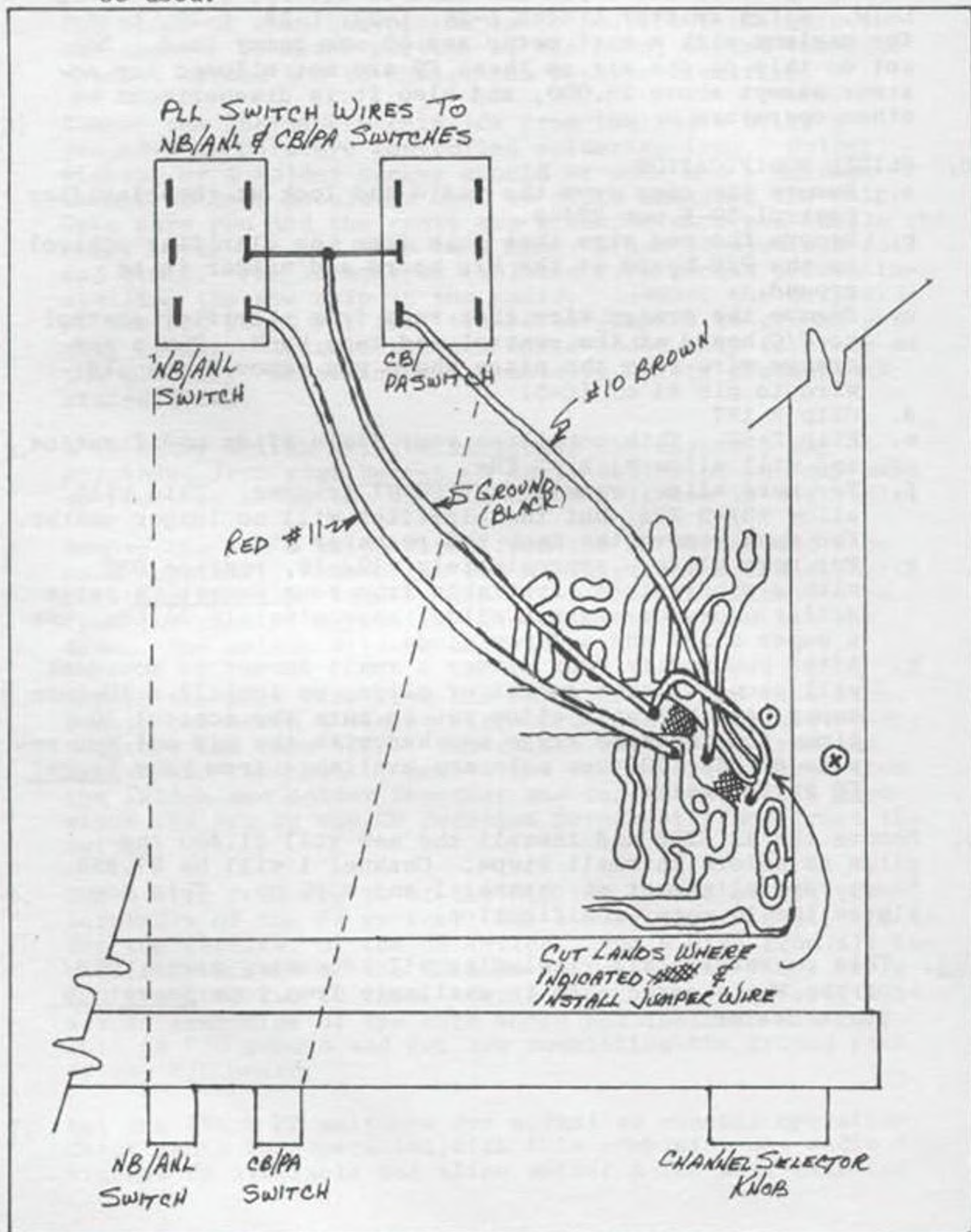



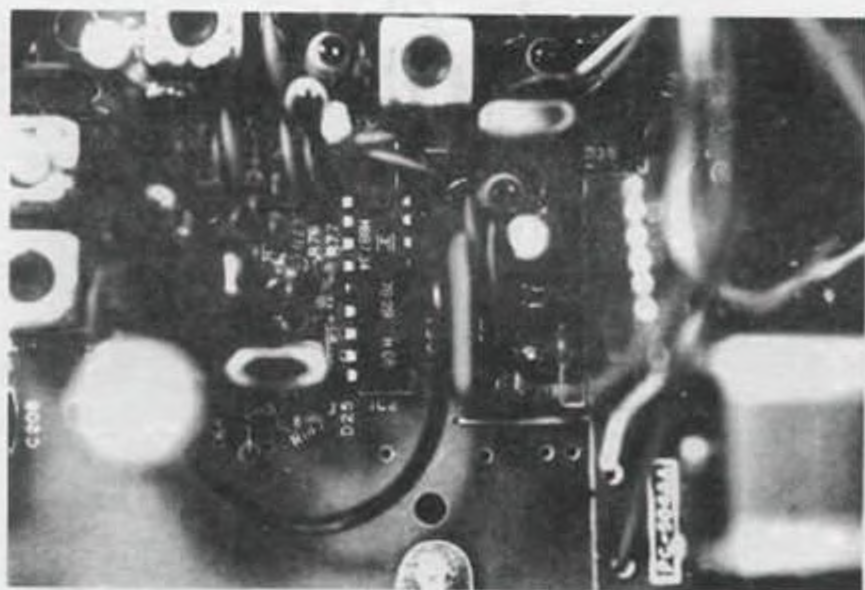
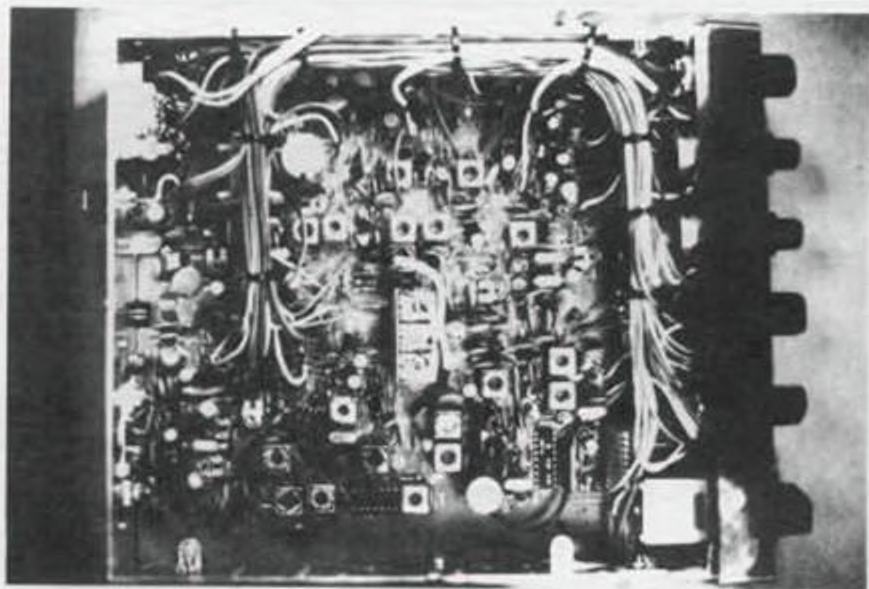



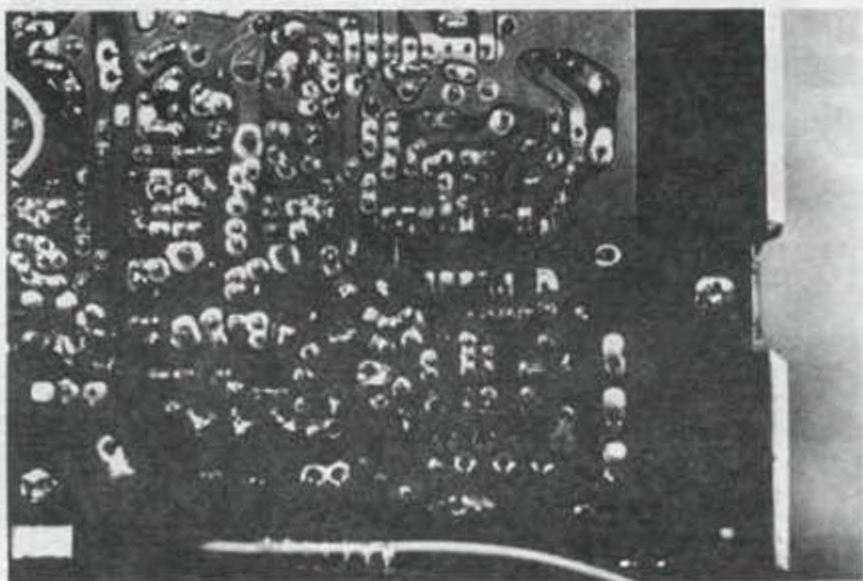



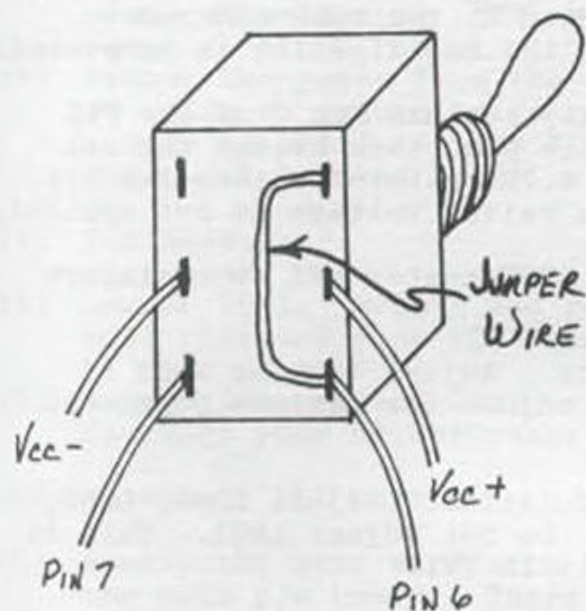

DPDT CENTER  
OFF MINIATURE  
TOGGLE SWITCH

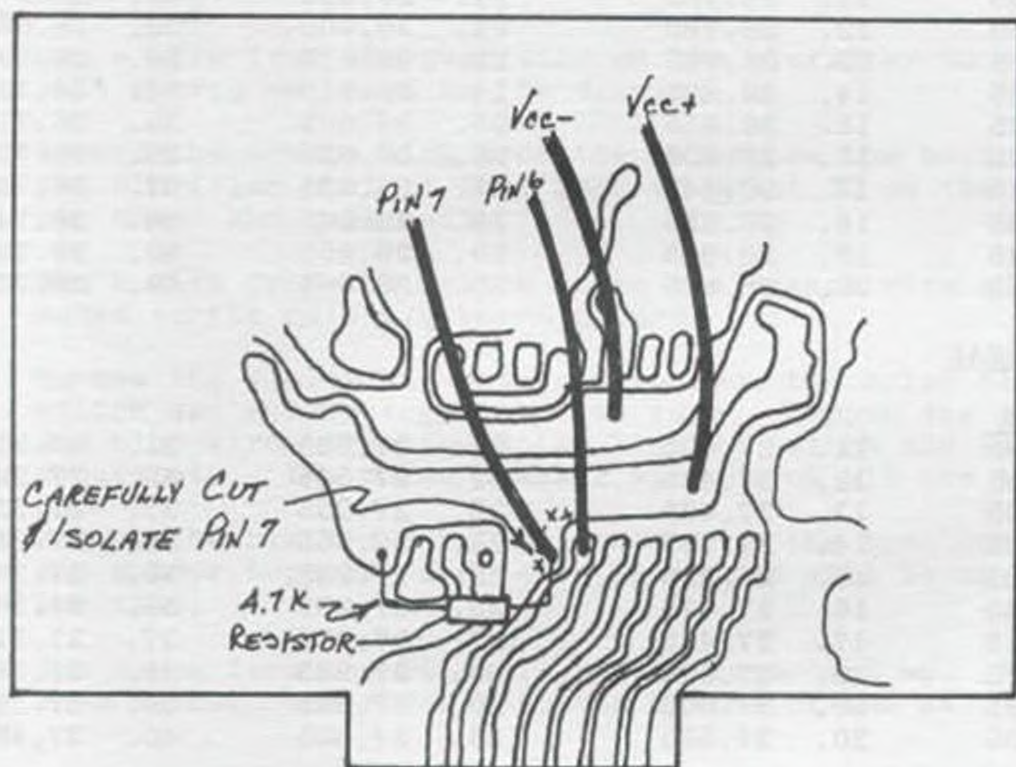

PLL BOARD

(SHOWING WIRING CONNECTIONS  
TO IC 801)



## CHANNEL EXPANSION FOR REALISTIC TRC 431

1. Remove the bottom cover and expose the P/C board. There is a metal cover over the PLL. Bind up the tabs and remove. This will be reinstalled after the modification is completed.
2. Using an exacto knife, carefully isolate Pin 7 of the PLL chip IC801 by cutting around the pin, then bridge the cut with a 4.7K  $\frac{1}{4}$ W resistor. The 4.7K resistor allows the pin to go to its normal state when switch voltage is not applied.
3. Construct a switch kit using a DPDT center off subminiature toggle switch.
4. Check fo output on all channels. Adjust T802 or T803 if necessary. Insert 1000Hz and adjust for maximum power out with a peak reading meter.
5. Adjust VR7 for ALC maximum modulation. Adjust L901, L902, L903, L904, L905, L907, L910. Do not adjust L901. This is the 54 MHz trap and will result in TVI.

### POSITION 1

1. 26.645	11. 26.765	21. 26.895	31. 26.675
2. 26.655	12. 26.785	22. 26.905	32. 26.685
3. 26.665	13. 26.795	23. 26.615	33. 26.695
4. 26.685	14. 26.805	24. 26.915	34. 26.705
5. 26.695	15. 26.815	25. 26.605	35. 26.715
6. 26.705	16. 26.835	26. 26.625	36. 26.725
7. 26.715	17. 26.845	27. 26.635	37. 26.735
8. 26.735	18. 26.855	28. 26.645	38. 26.745
9. 26.745	19. 26.865	29. 26.655	39. 26.755
10. 26.755	20. 26.885	30. 26.665	40. 26.765

### CENTER NORMAL

#### POSITION 2

1. 27.285	11. 27.405	21. 27.535	31. 27.315
2. 27.295	12. 27.425	22. 27.545	32. 27.325
3. 27.305	13. 27.435	23. 27.255	33. 27.335
4. 27.325	14. 27.445	24. 27.555	34. 27.345
5. 27.335	15. 27.455	25. 27.245	35. 27.355
6. 27.345	16. 27.475	26. 27.265	36. 27.365
7. 27.355	17. 27.485	27. 27.275	37. 27.375
8. 27.375	18. 27.495	28. 27.285	38. 27.385
9. 27.385	19. 27.505	29. 27.295	39. 27.395
10. 27.395	20. 27.595	30. 27.305	40. 27.405



## ROBYN MODEL SB-540D 10 METER AMATEUR CONVERSION

- (1) Remove PLL unit from radio using a temperature control grounded soldering iron and a solder sucker.
- (2) Remove the cover from the unit and isolate pins #7 and #8 using an exacto knife to cut the p/c board. Solder a wire to pin 9, 8, and 7 approximately ten inches long. This will be used later.
- (3) Cut R642.
- (4) Locate D611. Remove and replace with a super diode - this will increase your VCO range.
- (5) Remove and replace D631 with a super diode - this will increase your slider range.
- (6) Reinstall PLL unit.
- (7) Remove the gray wire from VR641 clarifier that goes to the main p/c board. There are two wires on the control, One goes to the mike plug. Do not remove the wire to the mike plug.
- (8) Run a wire from the gray wire on the clarifier to the 9.20 volt source as shown in the drawing.
- (9) Remove the orange wire from the switch on the back of the clarifier control that goes to point 13 on the main p/c board and tape back.
- (10) Run a wire from the switch where the orange wire was removed to the main p/c board ground.
- (11) Remove the violet and orange wire from the noise blanker switch and solder together then tape. Remove the yellow and blue wires from the noise blanker switch and tape separately. The noise blanker will be on all the time.
- (12) Remove the black and yellow wires from the tone control and solder together and tape. Low tone will be on all the time.
- (13) The wires from the PLL will now be connected up. Run them through the chassis to the bottom of the set.



ROBYN MODEL SB-540D CONTINUED

- (14) The wire from pin #9 goes to the common of both switches.
- (15) The wire from pin #8 goes to the front terminal or the n/c position of the tone switch.
- (16) The wire from pin #7 goes to the noise blanker switch front terminal.
- (17) VC631 is adjusted on normal channels with the clarifier control at 12:00.
- (18) The slide will allow +5KC and -4KC.
- (19) L611, L621, L451, L442, L431, L421, L413, L412, UR312, SSBALC, UR311, AMALC, UR531 AM POWER must be tuned for the upper frequency and power.





REVISIONS  
DATE  
BY

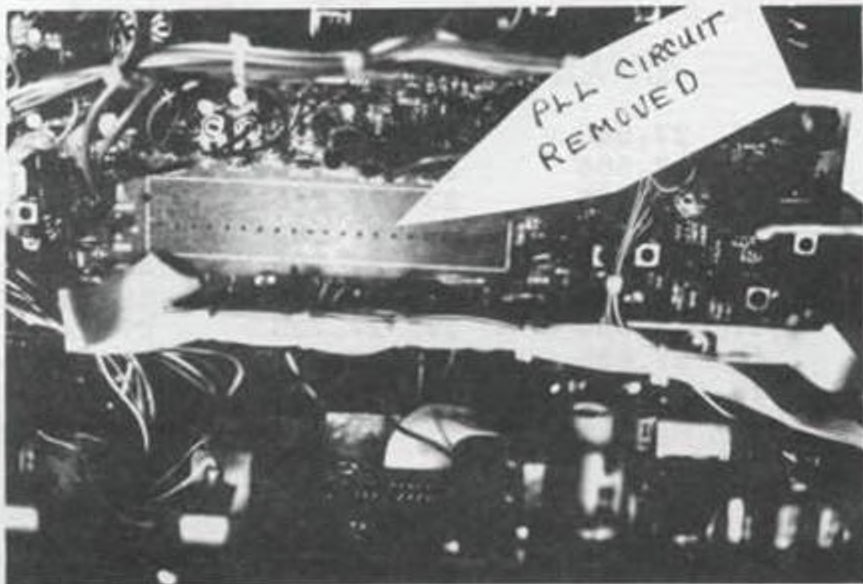

100-100-1  
100-100-2  
100-100-3  
100-100-4  
100-100-5  
100-100-6  
100-100-7  
100-100-8  
100-100-9  
100-100-10  
100-100-11  
100-100-12  
100-100-13  
100-100-14  
100-100-15  
100-100-16  
100-100-17  
100-100-18  
100-100-19  
100-100-20  
100-100-21

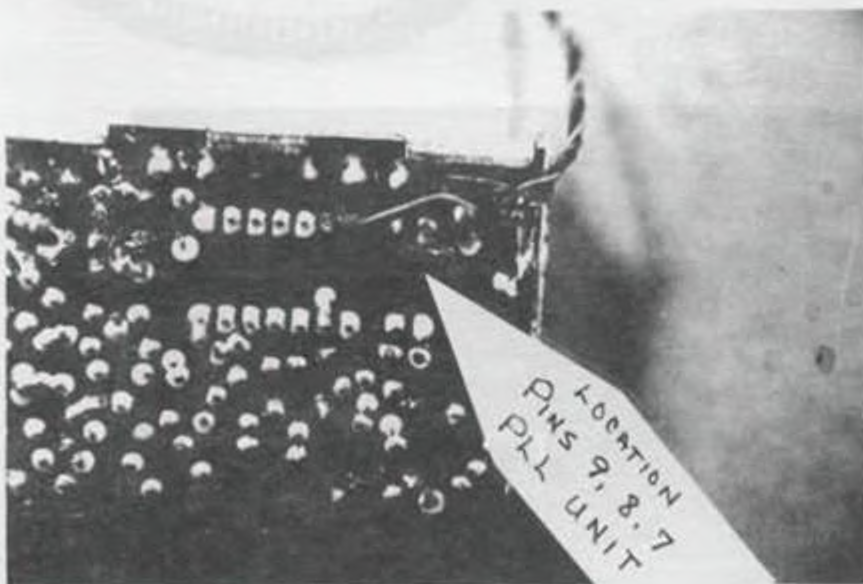



ROBYN SB-540-D CONTINUED:

TONE "ON"  
 BOTH "OFF" NORMAL

1	27.425	11	27.545	21	27.675	31	27.775
2	27.435	12	27.565	22	27.685	32	27.785
3	27.445	13	27.575	23	27.715	33	27.795
4	27.465	14	27.585	24	27.695	34	27.805
5	27.475	15	27.595	25	27.705	35	27.815
6	27.485	16	27.615	26	27.725	36	27.825
7	27.495	17	27.625	27	27.735	37	27.835
8	27.515	18	27.635	28	27.745	38	27.845
9	27.525	19	27.645	29	27.755	39	27.855
10	27.535	20	27.665	30	27.765	40	27.865

NB "ON"

1	27.875	11	27.995	21	28.125	31	28.225
2	27.885	12	28.015	22	28.135	32	28.235
3	27.895	13	28.025	23	28.165	33	28.245
4	27.915	14	28.035	24	28.145	34	28.255
5	27.925	15	28.045	25	28.155	35	28.265
6	27.935	16	28.065	26	28.165	36	28.275
7	27.945	17	28.075	27	28.175	37	28.285
8	27.965	18	28.085	28	28.185	38	28.295
9	27.975	19	28.095	29	28.195	39	28.305
10	27.985	20	28.115	30	28.215	40	28.315

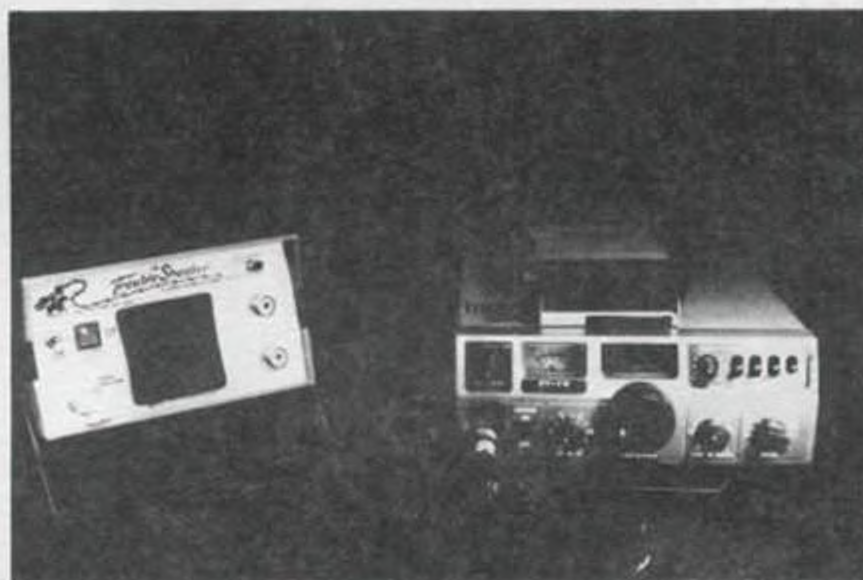



POWER, FREQUENCY CONVERSION TO 28.045  
AND CLARIFIER MODIFICATION



SBE LCBS-4 40 CHANNEL SSB BASE



SBE LCBS-4 40 CHANNEL SSB BASE  
POWER, FREQUENCY CONVERSION TO 28.045  
AND CLARIFIER MODIFICATION

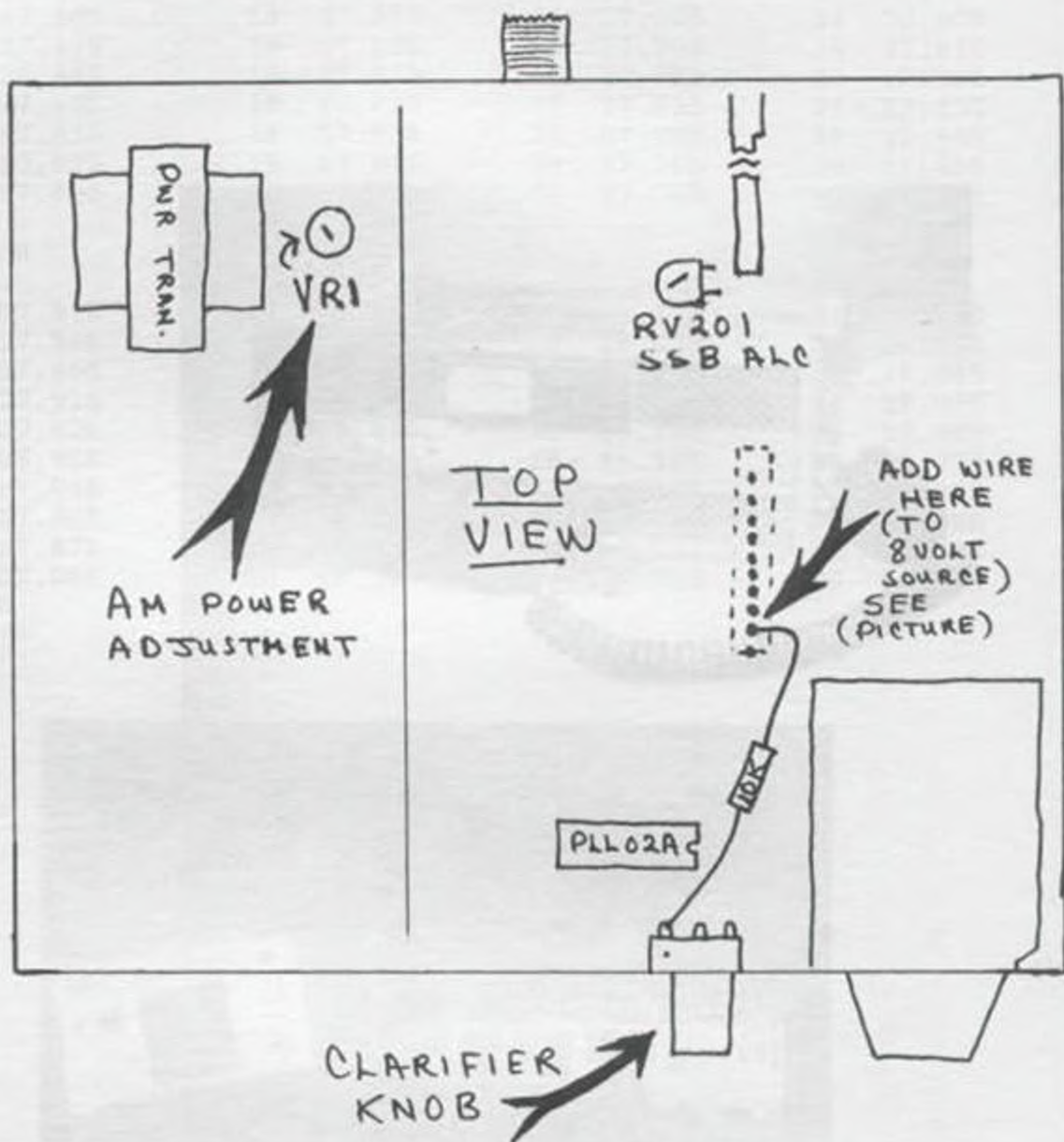

FIG. A.



FIGURE B.

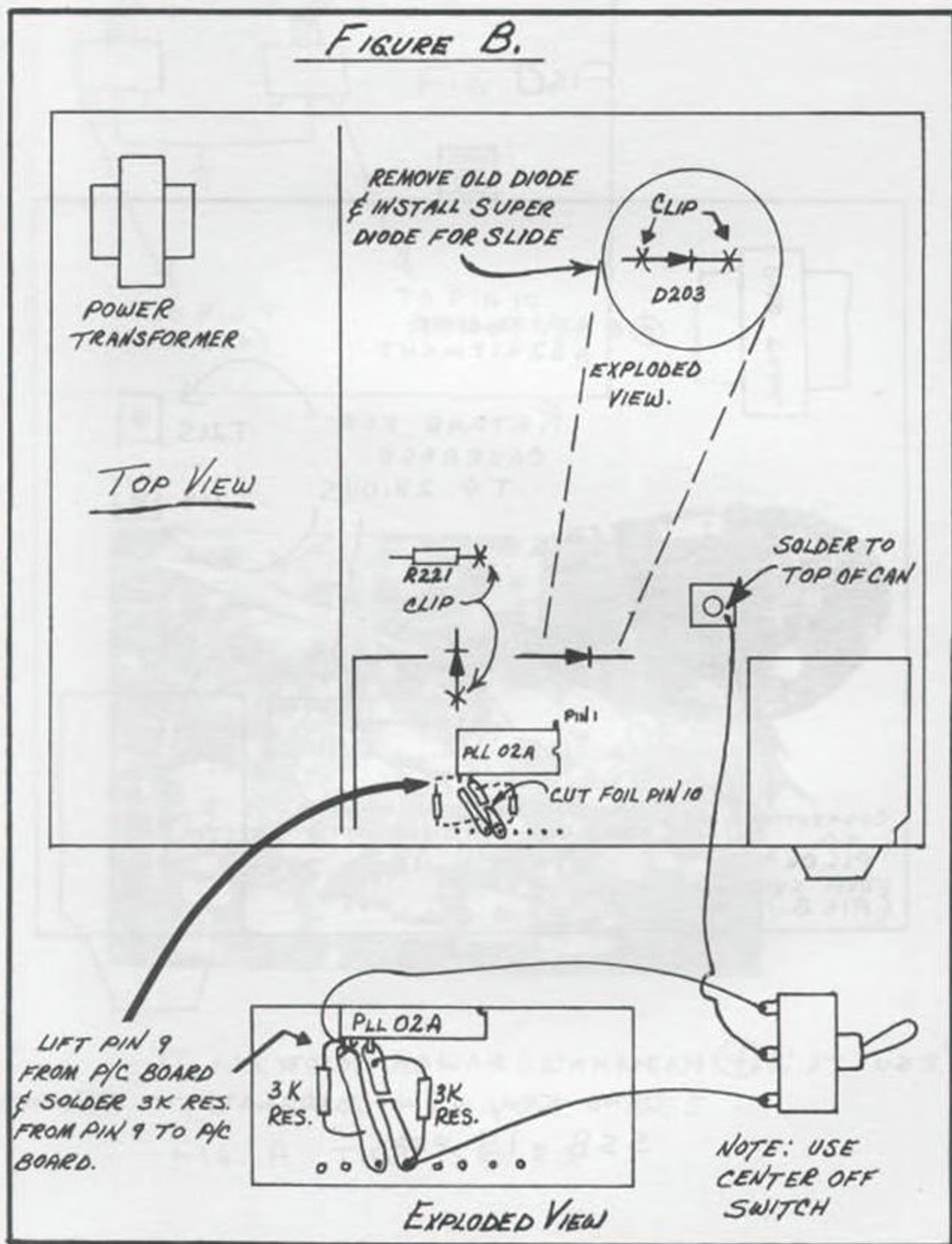
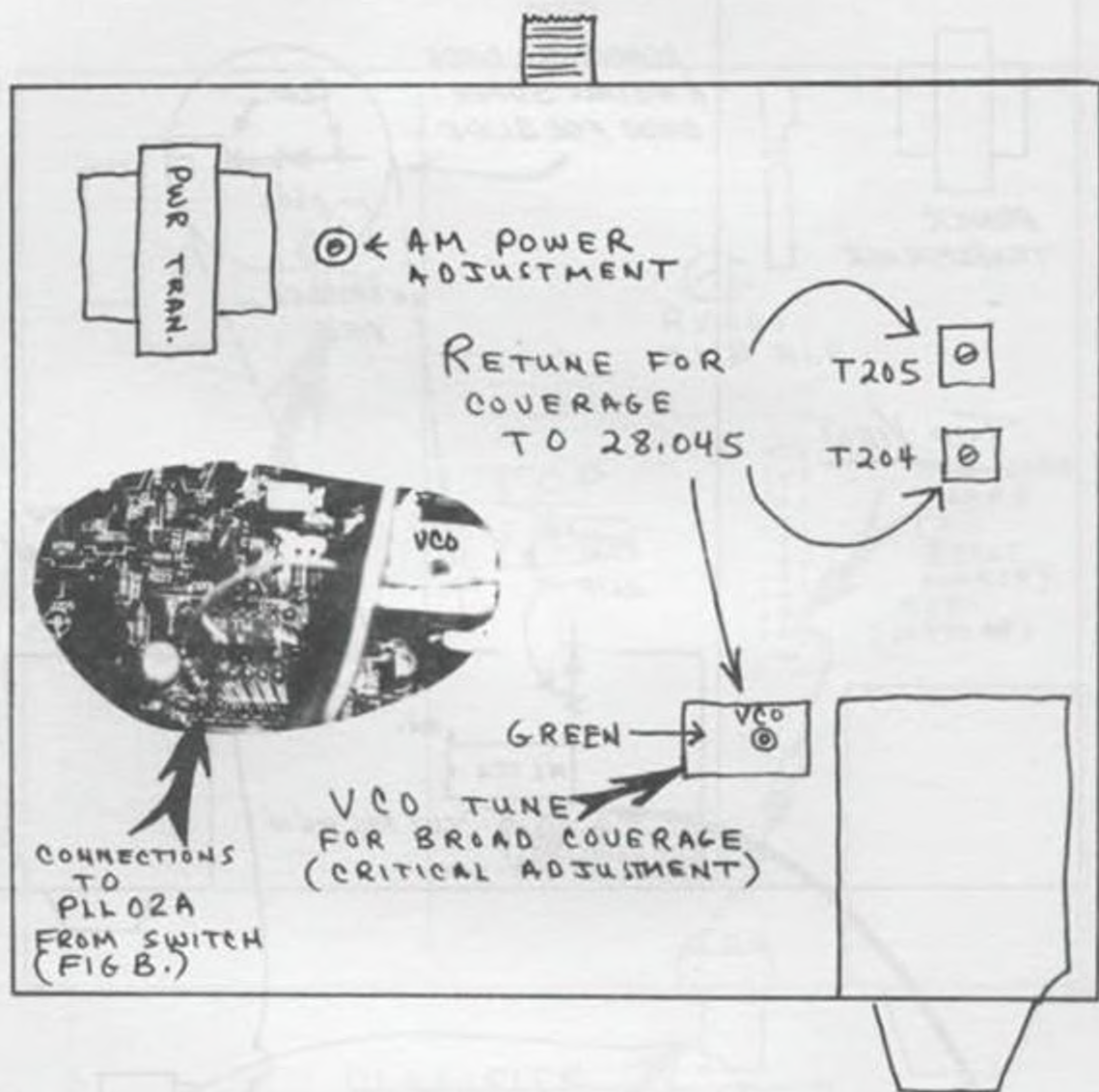

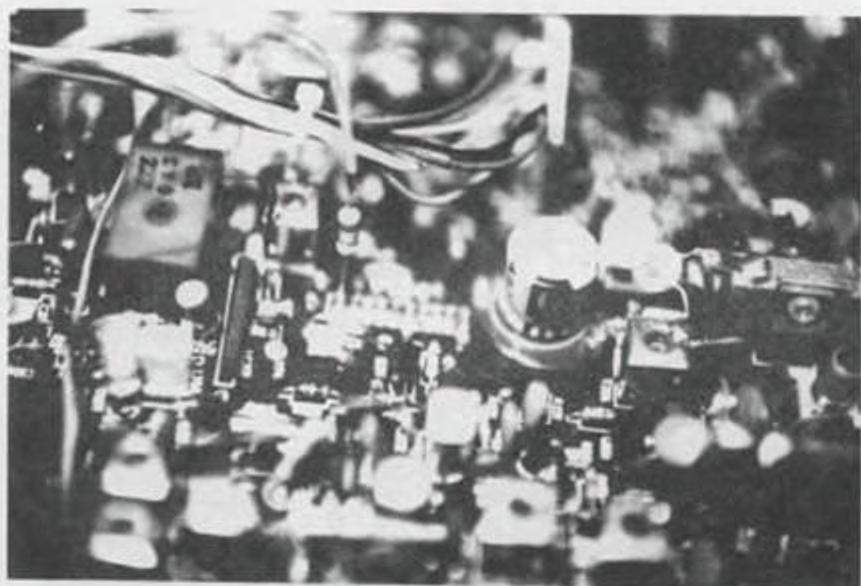
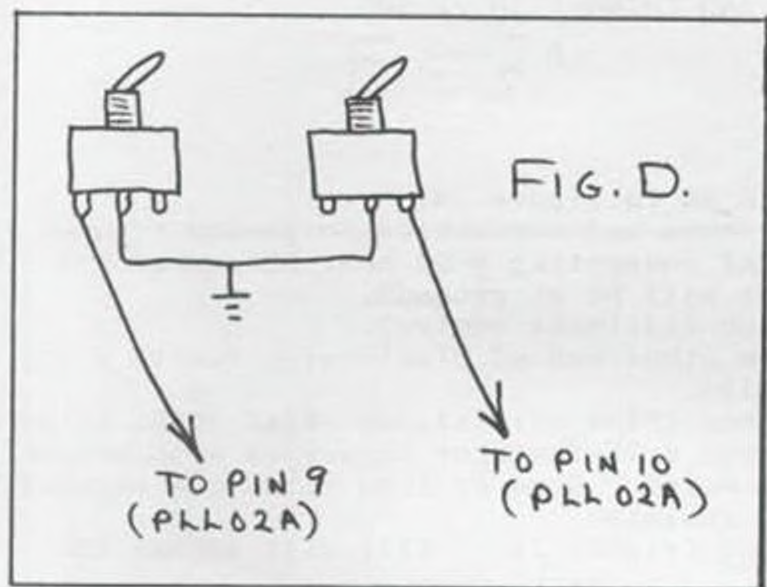

FIG. C



RESULTS: ① NOMINAL POWER OUT  
 DEAD KEY 10W MODULATE TO 25WATTS  
 SSB 15 PEAK





PLACEMENT OF 10K RESISTOR  
TO 8 VOLT SOURCE SEE  
FIG. A THIS SERIES



MODIFICATION SBE LCMS-4  
SLIDE AND CHANNEL TO 27.595

INSTRUCTIONS

- (1) Cut collector of Q23.
- (2) Cut "lands" or prints as in figure 1A.
- (3) Install two SPST switches and run center to ground (figure 1A).
- (4) Cut violet wire off of connecting post near D8 and ground.  
(This is so clarifier will be at ground).
- (5) Remove R140 located on clarifier control.
- (6) Clip orange wire from other end of clarifier. Run to 8 volt source (emitter of Q18).
- (7) Note: With stock diode (D13) unit slides  $-2\frac{1}{2}$ KC +2KC. (figure 2A).  
With super diode insert 4.7K resistor in series with orange wire for +2.5KC -8KC slide. More or less slide can be obtained by changing value of resistor.
- (8) VR7 will adjust AM Mod (figure 2A). VR11 will adjust SSB ALC (figure 2A).
- (9) This modification should take care of sliding capabilities and take radio to 27.595. It is probably possible to take radio higher, but we do not have the knowledge at the time of production of this book.

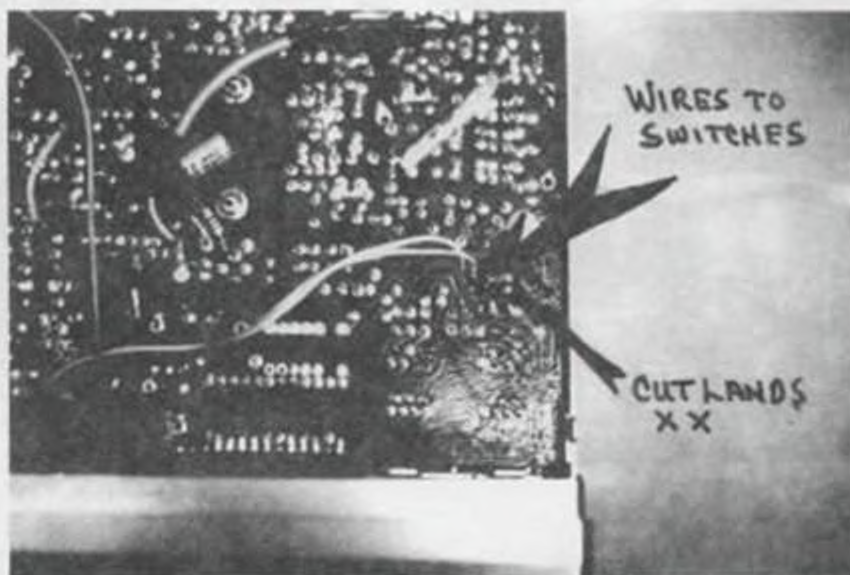

CUTS AND CONNECTIONS AS  
PER DRAWING FIG 1A



FIG. 2A

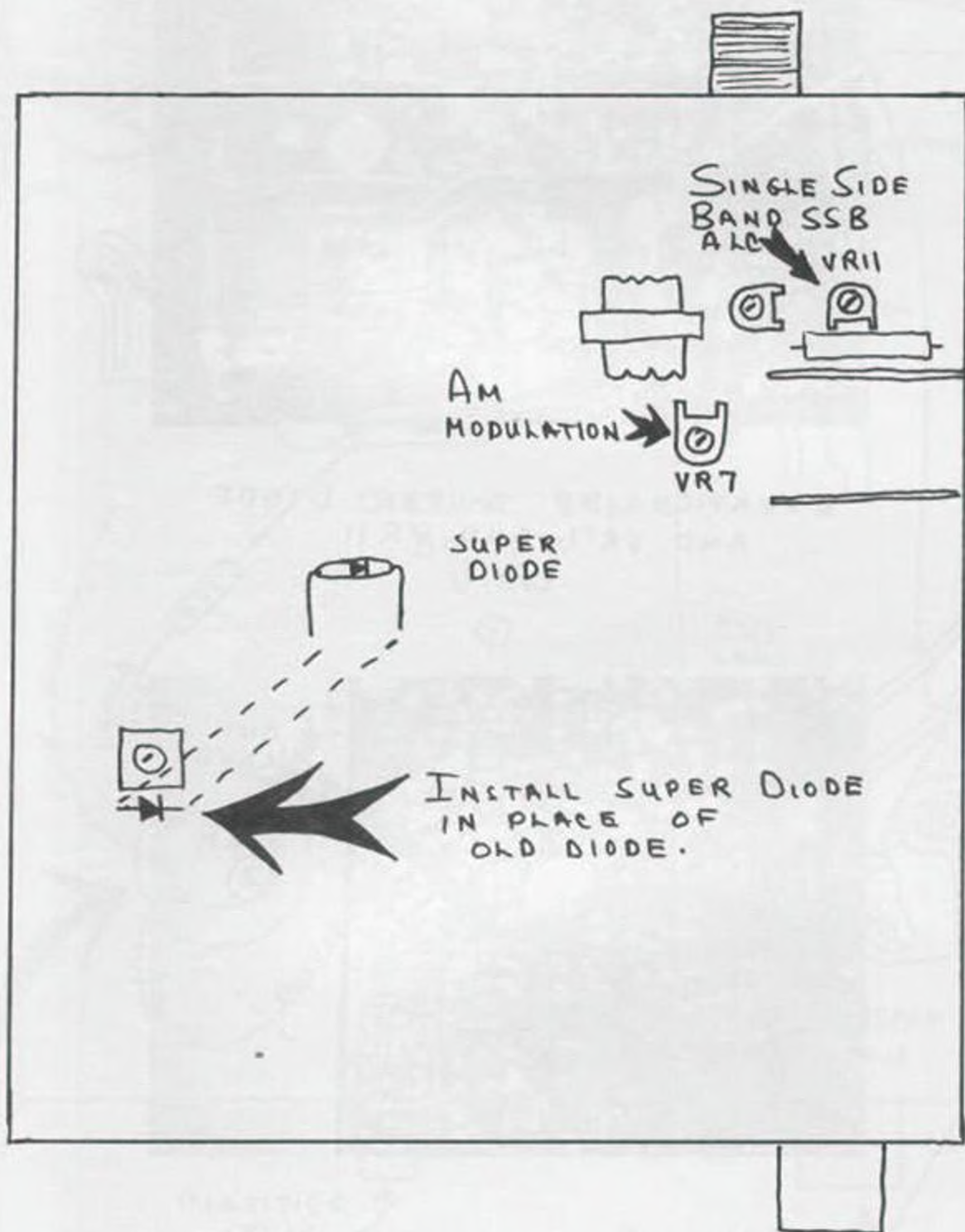



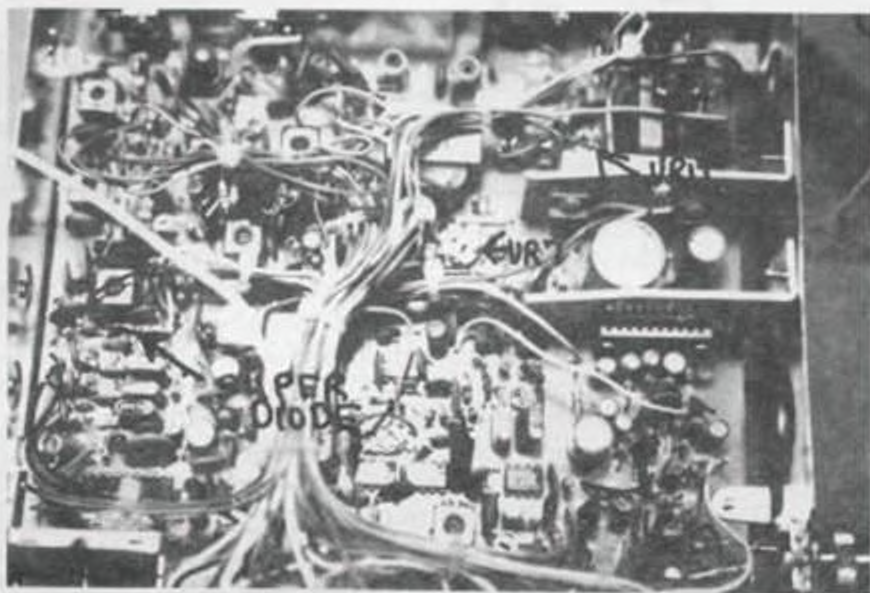

LOCATION OF SUPER DIODE  
AND VR7 AND VR11

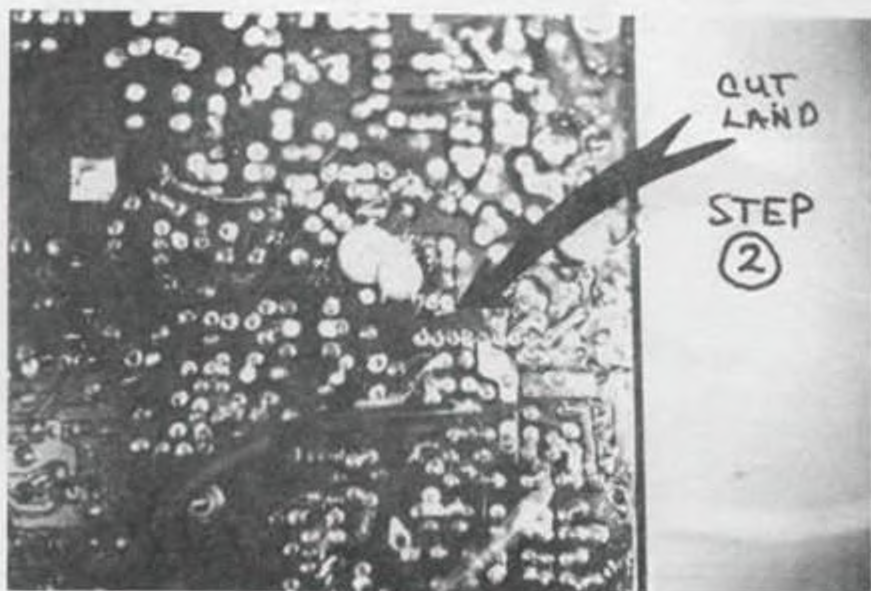

STEP 2 LOCATION



FIG. 1A

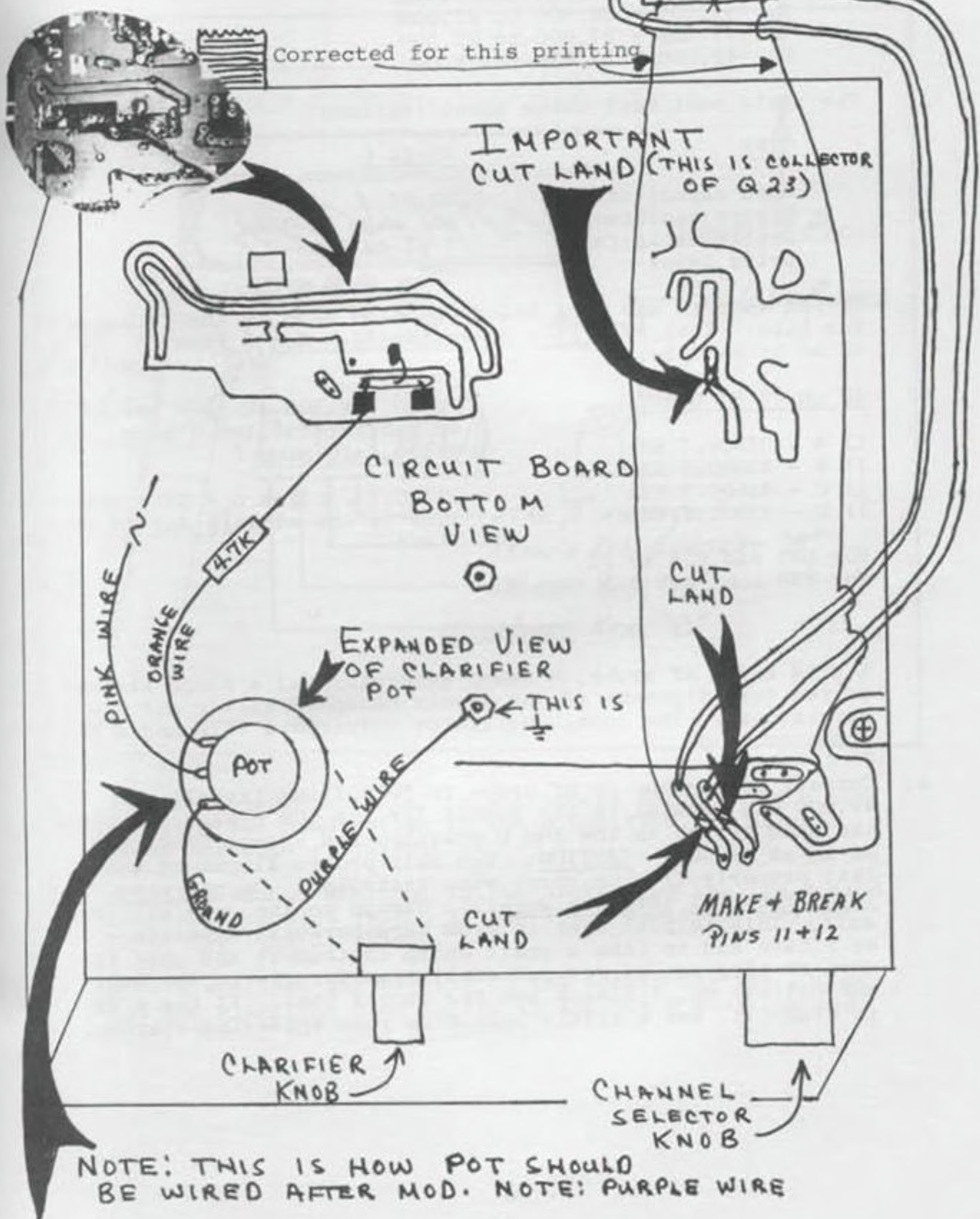



# YAESU FT-7B 11M CONVERSION

26.000 - 28.000

1. You will need 4 xtals from your favorite parts supplier:
  - A. 40.500 - 26.000 to 26.500
  - B. 41.000 - 26.500 to 27.000
  - C. 41.500 - 27.000 to 27.500
  - D. 42.000 - 27.500 to 28.000

The xtals must meet these specifications:

<u>TYPE</u>	<u>HC-25 U</u>
Load capacitance	30 pf
Series resistance	25 ohms or less
Static capacitance	7 pf or less
Drive level	5mw

2. If you want to use your fixed position here is the formula for this:  $Xtal F\emptyset = F1 - \text{operating } F\emptyset$ . Let's take Ch. 19 AM as an example.

#### AM OR CW F1 CHART

11 A - 31500.7 KHz  
11 B - 32000.7 KHz  
11 C - 32500.7 KHz  
11 D - 33000.7 KHz

$F\emptyset$  IN MHZ FOR AM 19 = 27.185  
so subtract 27,185.0 from  
32500.7 in band C

$32500.7 - 27185.0 = 5315.7\text{KHz}$   
This is the xtal  $F\emptyset$  for AM 19  
fixed.

For LSB add 0.8 to F1

For USB subtract 2.2 from F1

#### CONVERSION

1. A VTVM and a RF probe, a sweep generator and a scope are required for alignment of the premix bandpass filter and the premix unit. The local oscillator requires a VTVM and a RF probe or scope.
2. Connect your scope or RF probe to TP1901 and install a 42.000 MHz crystal in the socket for the 10m D band and place the band switch in the 10m D position and adjust T1901 for 50 mv at TP1901. **CAUTION:** Use only proper alignment tools that properly fit the cores when installed. Do not ever force the tool into the core!!! Damage to the core will result. This helpful hint is from hard personal experience as I have had to take a small sharp instrument and chip the core or slug out of several small transformers in the past, and believe me, I always use the proper tool. If the slug is stubborn, use a little heat from your soldering station.



YAESU 11M CONVERSION CONTINUED:

Place the tip on the slug and heat it up, then even the most stubborn slug will move. Break it and you have had it.

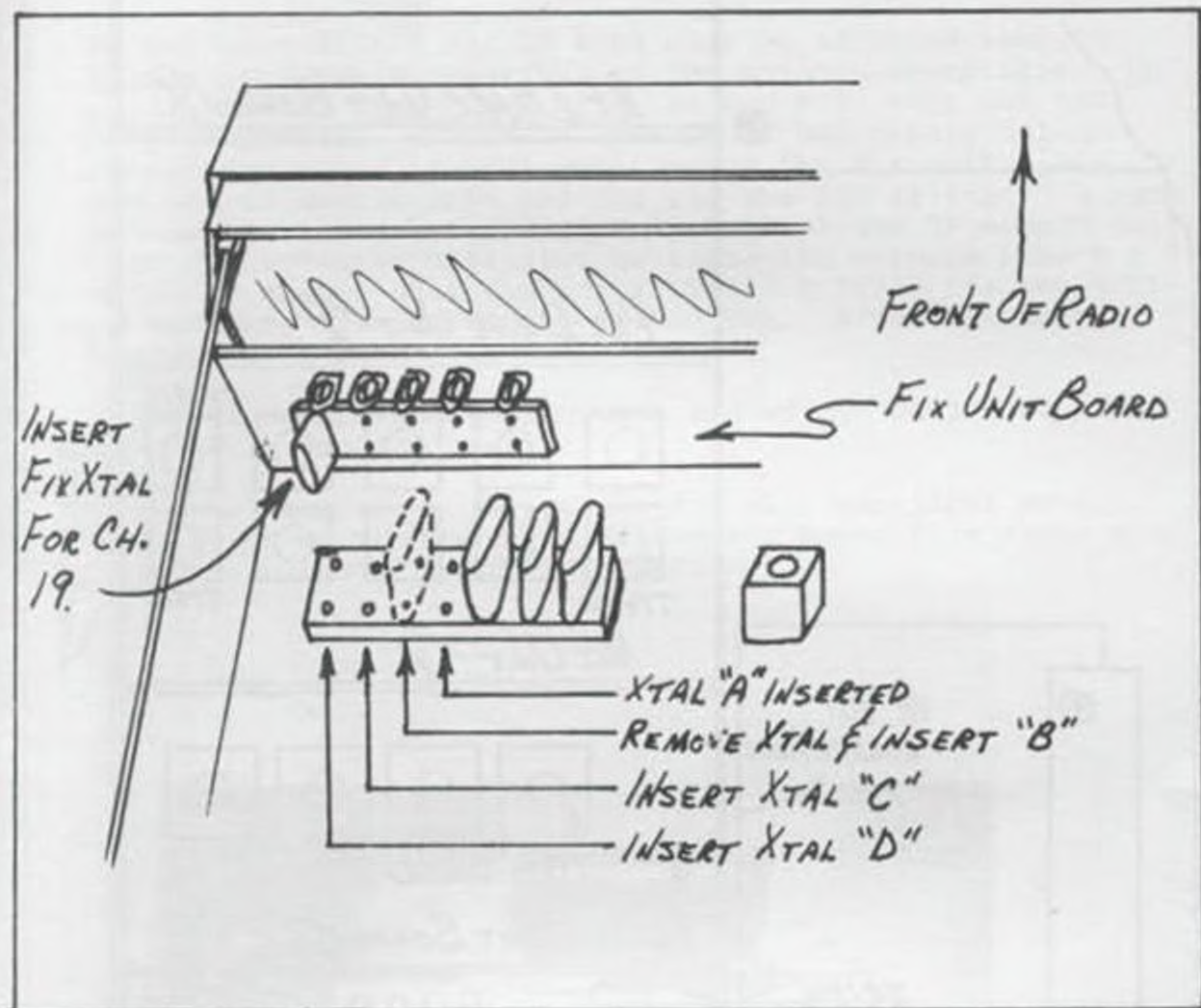

3. Install a 41.000 MHz xtal in the socket for the 10m B band and place the band switch in 10m B position and adjust TC1905 for 50mv at TP1901.
4. Install a 40.500 MHz xtal in the socket for the 10m A band and place the band switch in the 10m A position. Adjust TC1904 for 50mv at TP1901.
5. Install a 41.500 MHz crystal in the socket for the 10C MHz band and place the band switch in the 10m D position and adjust TC1906 for 50mv at TP1901.



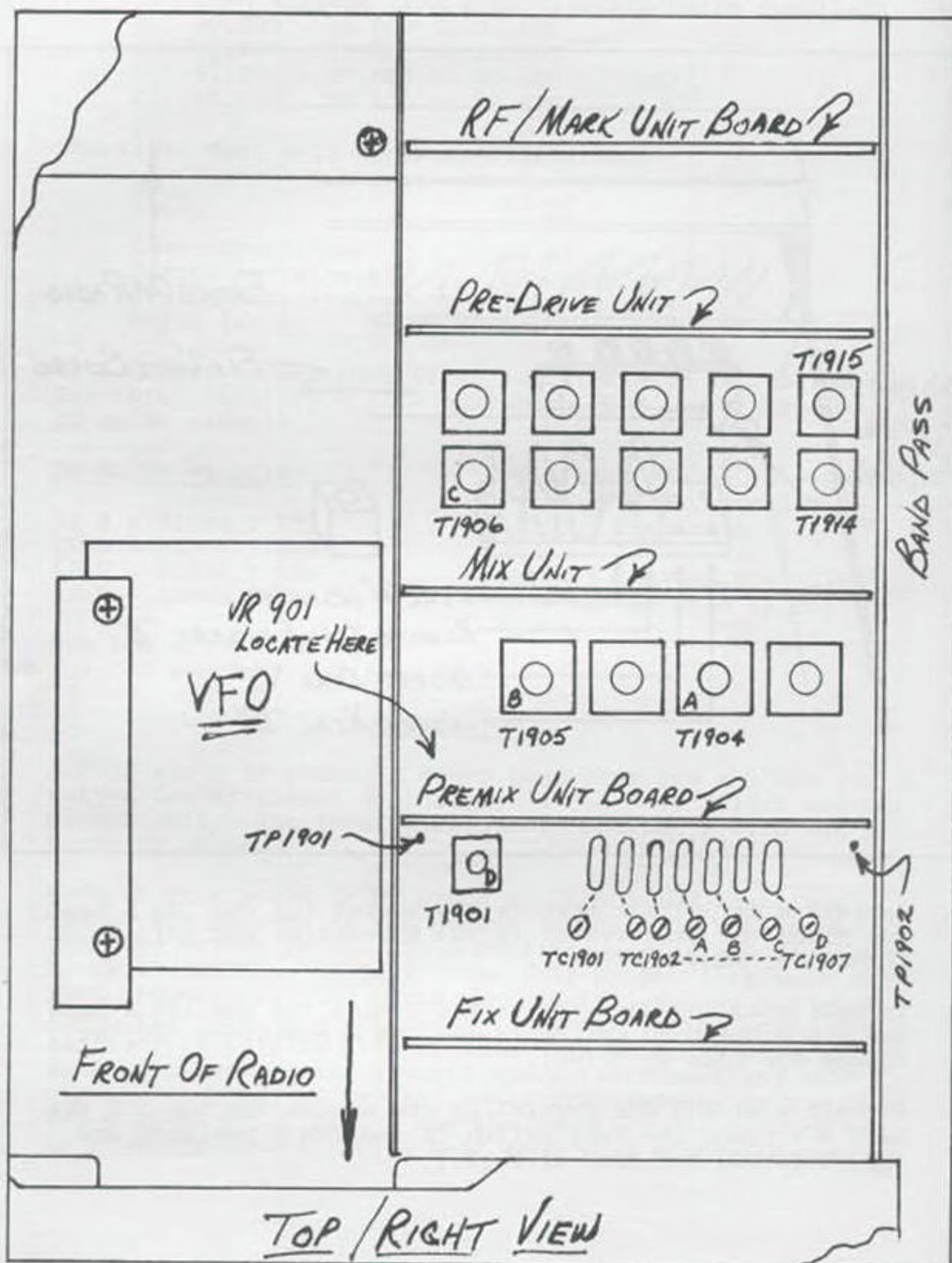



## YAESU 11M CONVERSION CONTINUED:

6. Premix balance adjust is VR901. Using your RF probe, connect it to TP1902. Adjust the VFO/FIX switch to the FIX position and adjust for a minimum reading with VR901 on your VTVM.
7. The bandpass filter for TX & RX must be adjusted next. Connect your sweep generator to the antenna receptacle. Do not transmit. Remove the mike, as you will wipe out your sweep generator. This will cost you a BIG repair bill. Connect the scope to Q201 emitter on the mix unit. Remove the IF module unit and cut off the AGC voltage. A jumper must be installed between pins 10 & 11 of the RF module unit. A 100 ohm resistor must also be connected between pins 8 & 9 on the RF module unit and adjust T1914 & T1915 for the flattest response from 26.000 to 28.000 MHz. After alignment return set to normal.
8. Connect a dummy load to the unit and adjust T1920 for maximum out in the 10m section.

This completes the modification for this excellent mobile. The installation of the matching F $\emptyset$  counter makes this radio a winner. Good luck with your modification.





# IMPROVED SLIDE MODIFICATION FOR 02A SSB RADIOS

CYBERNET CHASSIS

(COLT 1000, DAK X, MIDLAND 882C, RCA)  
ETC.

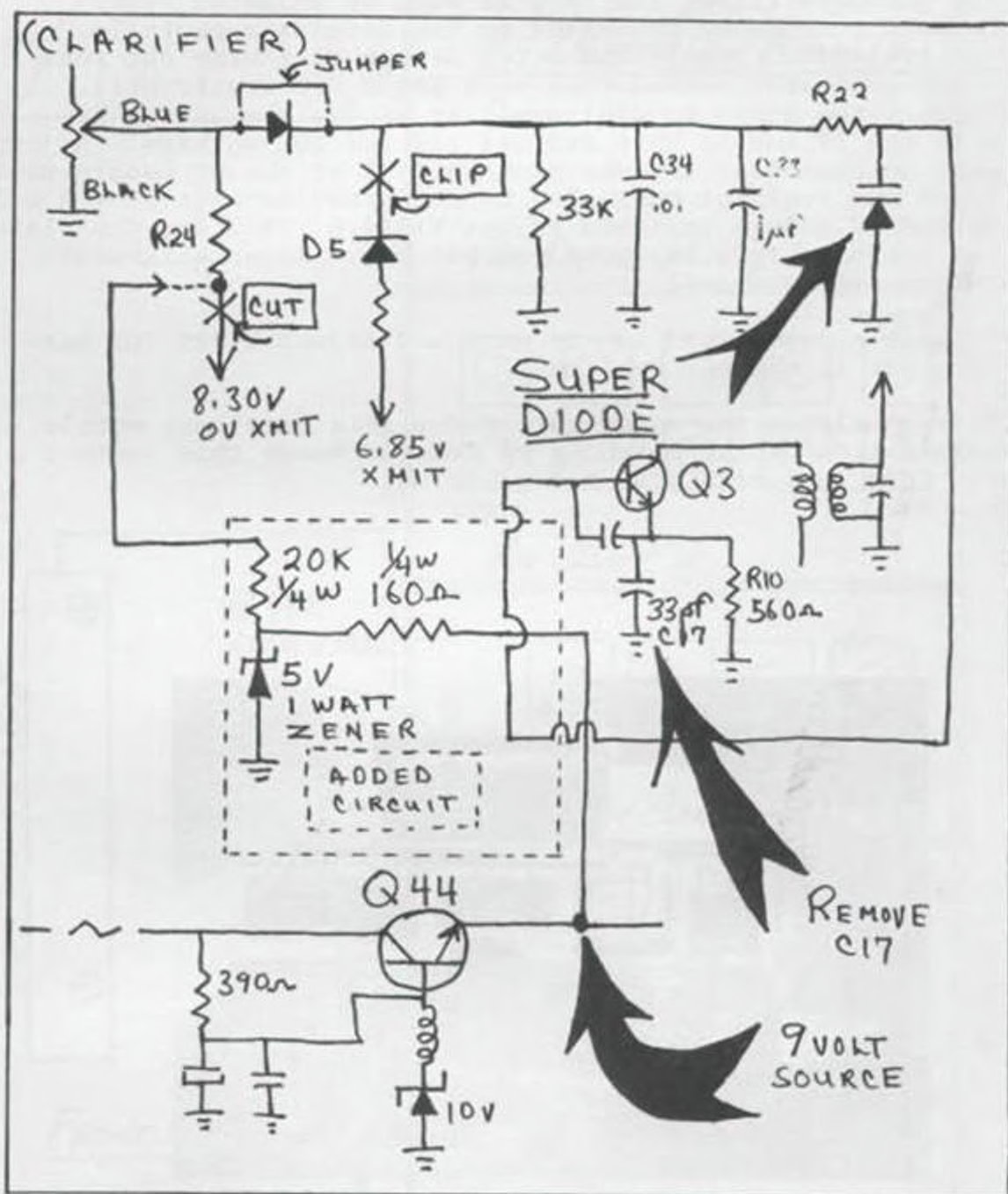

CURES TX-RX SPLIT



# THE COMPLETE UPDATED 200 CHANNEL AMATEUR CONVERSION

FOR UNIDEN 858 CHASSIS

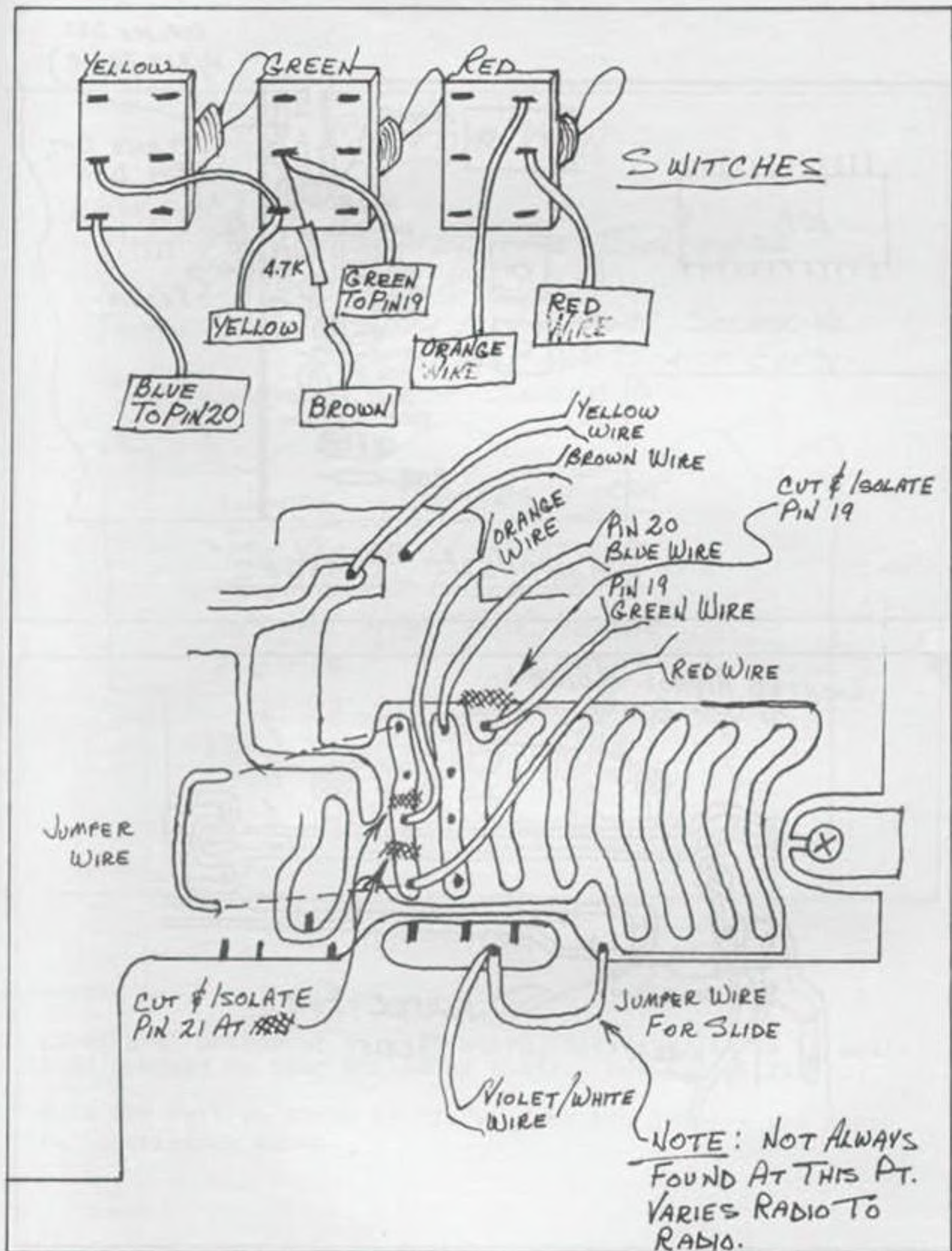



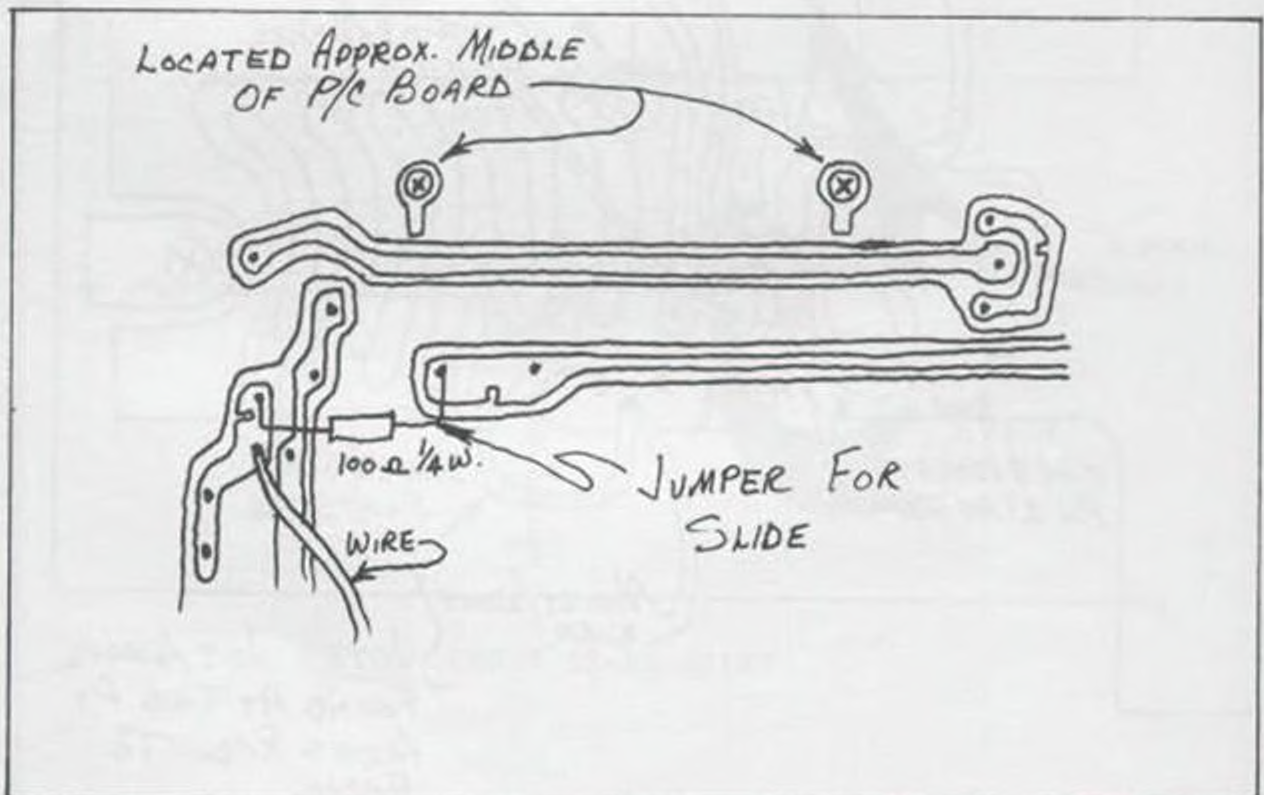
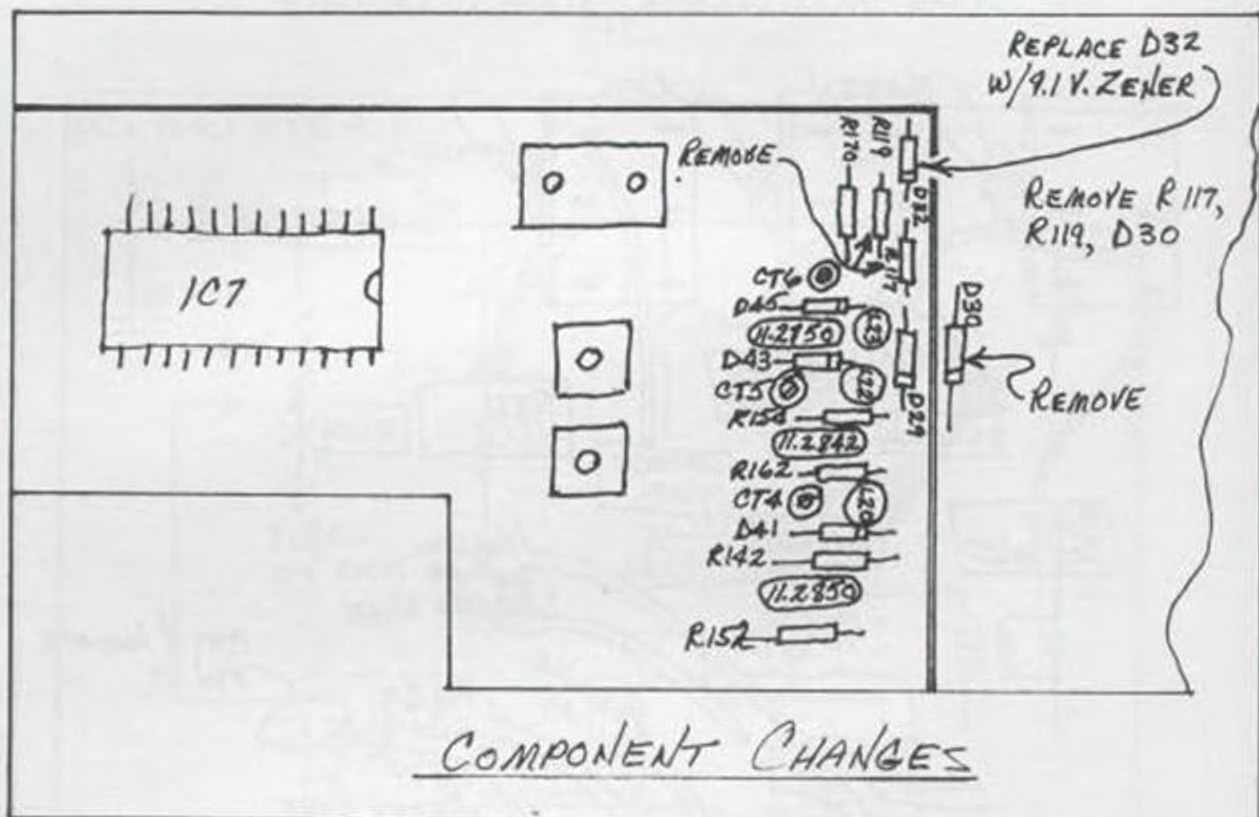



## 200 CHANNEL CONVERSION CONTINUED:

THIS MODIFICATION MUST BE INSTALLED SO THE RADIO WILL COVER THE ENTIRE RANGE WITHOUT A LOSS OF POWER.

### BOTTOM VIEW

#### IMPORTANT INFO:

USE ONLY ISOLATED TYPE SOLDERING IRON. (DO NOT USE A GUN!)

TOUCH CHASSIS WITH IRON BEFORE SOLDERING TO DISCHARGE ANY STATIC ELECT.

HOLD CHASSIS WHILE SOLDERING

INSTALL JUMPERS FIRST  
THE ABOVE INSTRUCTIONS SHOULD BE FOLLOWED TO INSURE NOT TO DAMAGE FET'S!

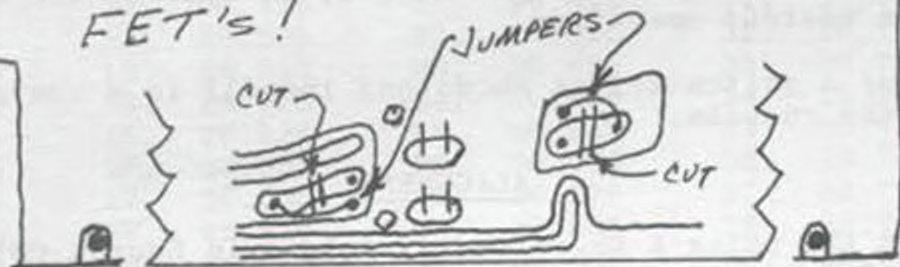

#### INSTRUCTIONS

1. Locate L-37.
2. Looking at bottom of circuit board, locate areas to be modified (should be near bottom of L-37). Cut traces first.
3. Make two cuts as shown by "11". Make two jumpers and place in location as shown.



## 200 CHANNEL CONVERSION CONTINUED:

### SLIDE INSTRUCTIONS:

Remove D30, D32, R119, and R117. Install jumper as shown in drawing. Install a 9.1V zener where D32 was removed.

Locate the violet/white wire from the clarifier control and follow it to the P/C board. Cut it loose and ground it. For maximum clarifier install a super diode in place of D45, D41, and D43. For more upward slide remove CT4, CT5, and CT6.

When you increase your slide, the clarifier gets very touchy and hard to tune, so replace your stock pot with a Secret CB Super 10 turn pot. The shaft is slightly larger than the old one, so you must carefully enlarge the hole in the knob, just so it is a snug fit and shove it on. If you make the hole too large, you will have to glue it.

Now you are ready to align your radio. You will not want to make the jump from 11 meters to 10 meter coverage too quickly, so take it easy and in small steps. I suggest you make your radio perform on the 11 meter F $\phi$ ; then you will want to install the new xtals to make the modification complete to 10 meter amateur band.

You will need a shielded dummy load (Secret CB's "Little Dummy" is a good choice), an RF voltmeter, a two-tone generator (plans in Secret CB), a frequency counter, % modulation meter and/or a scope, and a signal generator. Do not try to align your radio on an unshielded dummy or an antenna. This is not good practice and is discourteous as well as illegal, as some of the F $\phi$  are not allowed on amateur operation.

Make or buy a switch kit as shown and install in a convenient place on the chassis.

### ALIGNMENT

1. Adjust L24 using a RF voltmeter (plans in Secret CB) on test point 6 for maximum RF.
2. Adjust receiver section next for mid-band. Remember, we are adjusting the receiver in two steps; first for 11 meters, and then for 10 meters. If you try to do it in one step you'll get it all out of whack. Adjust your signal generator for mid-band and adjust L3, L4, L5, L7, L8. Check the bottom & top F $\phi$  for proper operation, then proceed to the transmitter.
3. Using a 1000 Hz tone on AM, adjust L30, L39, L37 for maximum peak RF output. Do not tune L27. Adjust VR7, VR8, & VR6 for maximum AM power & modulation. Switch to SSB and adjust CT7 for maximum SSB output. Cut R43 for more ANL range - this will give you 200% improvement on your noise blanker.



## 200 Channel Conversion Continued:

## RED SWITCH

1.	26.965	11.	26.085	21.	26.215	31.	26.315
2.	26.975	12.	26.105	22.	26.225	32.	26.325
3.	26.985	13.	26.115	23.	26.255	33.	26.335
4.	27.005	14.	26.125	24.	26.235	34.	26.345
5.	27.015	15.	26.135	25.	26.245	35.	26.355
6.	27.025	16.	26.155	26.	26.265	36.	26.365
7.	27.035	17.	26.165	27.	26.275	37.	26.375
8.	none	18.	26.175	28.	26.285	38.	26.385
9.	none	19.	26.185	29.	26.295	39.	26.395
10.	none	20.	26.205	30.	26.305	40.	26.405

## RED &amp; GREEN SWITCH

1.	26.965	11.	26.885	21.	27.015	31.	26.315
2.	26.975	12.	26.905	22.	27.025	32.	26.325
3.	26.985	13.	26.915	23.	26.255	33.	26.335
4.	27.005	14.	26.925	24.	27.035	34.	26.345
5.	27.015	15.	26.935	25.	27.045	35.	26.355
6.	27.025	16.	26.955	26.	26.265	36.	26.365
7.	27.035	17.	26.965	27.	26.275	37.	26.375
8.	26.855	18.	26.975	28.	26.285	38.	26.385
9.	26.865	19.	26.985	29.	26.295	39.	26.395
10.	26.875	20.	27.005	30.	26.305	40.	26.405

## RED &amp; YELLOW SWITCH

1.	26.565	11.	26.485	21.	26.615	31.	26.715
2.	26.575	12.	26.505	22.	26.625	32.	26.725
3.	26.585	13.	26.515	23.	26.655	33.	26.735
4.	26.605	14.	26.525	24.	26.635	34.	26.745
5.	26.615	15.	26.535	25.	26.645	35.	26.755
6.	26.625	16.	26.555	26.	26.665	36.	26.765
7.	26.635	17.	26.565	27.	26.675	37.	26.775
8.	26.455	18.	26.575	28.	26.685	38.	26.785
9.	26.465	19.	26.585	29.	26.695	39.	26.795
10.	26.475	20.	26.605	30.	26.705	40.	26.805

The frequencies will be the same as above if all three switches are thrown simultaneously.

Now you have completed the modification to expand slide and the channels to 28.045. Now to move the radio up to the complete 10 meter amateur band you must change the 3 mixer xtals X6 11.2850 - X 3 11.2858, X 4 11.2842 with 11.8850 - 11.8858 - 11.8842 available from your favorite supplier. Then repeat all of the alignment steps as before. Set the set for mid-band and align. If the set will not work at these F<sub>0</sub>, adjust the F<sub>0</sub> down until it will work, then align in small steps until you have the full range of the amateur band. If you have trouble getting RF power up to its rated output, lower the value of C170 & C167 approximately 100 pf.



## 200 CHANNEL CONVERSION CONTINUED

SWITCH CHART

## YELLOW &amp; GREEN SWITCH

1.	26.565	11.	27.485	21.	27.715	31.	27.715
2.	26.575	12.	27.505	22.	27.625	32.	27.725
3.	26.585	13.	27.515	23.	27.655	33.	27.735
4.	26.605	14.	27.525	24.	27.635	34.	27.745
5.	26.615	15.	27.535	25.	27.645	35.	27.755
6.	26.625	16.	27.555	26.	27.665	36.	27.765
7.	26.635	17.	27.565	27.	27.675	37.	27.775
8.	27.455	18.	27.575	28.	27.685	38.	27.785
9.	27.465	19.	27.585	29.	27.695	39.	27.795
10.	27.475	20.	27.605	30.	27.705	40.	27.805

## GREEN SWITCH

1.	26.965	11.	27.885	21.	28.015	31.	27.315
2.	26.975	12.	27.905	22.	28.025	32.	27.325
3.	26.985	13.	27.915	23.	27.255	33.	27.335
4.	27.005	14.	27.925	24.	28.035	34.	27.345
5.	27.015	15.	27.935	25.	28.045	35.	27.355
6.	27.025	16.	27.955	26.	27.265	36.	27.365
7.	27.035	17.	27.965	27.	27.275	37.	27.375
8.	27.855	18.	27.975	28.	27.285	38.	27.385
9.	27.865	19.	27.985	29.	27.295	39.	27.395
10.	27.875	20.	28.005	30.	27.305	40.	27.405

## YELLOW SWITCH

1.	26.565	11.	27.485	21.	27.615	31.	27.715
2.	26.575	12.	27.505	22.	27.625	32.	27.725
3.	26.585	13.	27.515	23.	27.655	33.	27.735
4.	26.605	14.	27.525	24.	27.635	34.	27.745
5.	26.615	15.	27.535	25.	27.645	35.	27.755
6.	26.625	16.	27.555	26.	27.665	36.	27.765
7.	26.635	17.	27.565	27.	27.675	37.	27.775
8.	27.455	18.	27.575	28.	27.685	38.	27.785
9.	27.465	19.	27.585	29.	27.695	39.	27.795
10.	27.475	20.	27.605	30.	27.705	40.	27.805



# 10 METER CONVERSION FOR SSB RADIOS

## USING MB8719 CHIP UNIDEN CHASSIS

Corrected page for this printing.

2 POLE/6 POSITION ROTARY SWITCH

3 - 1N914 DIODES

POS	FREQUENCIES
1	26.815-27.005
2	Normal
3	27.415-27.445 (37, 38, 39, 40)
4	27.455-27.725
5	27.605-28.045
6	Normal

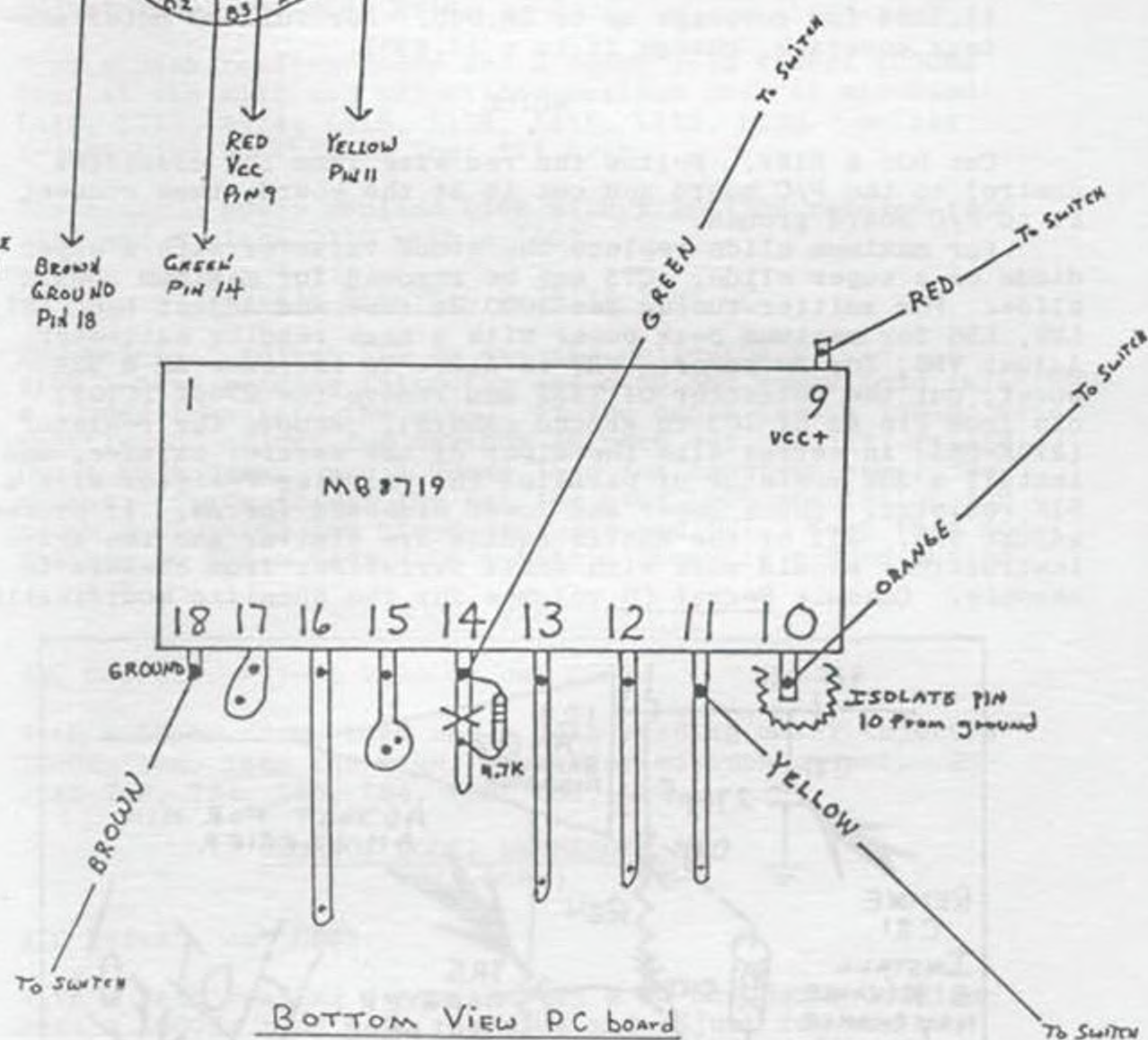
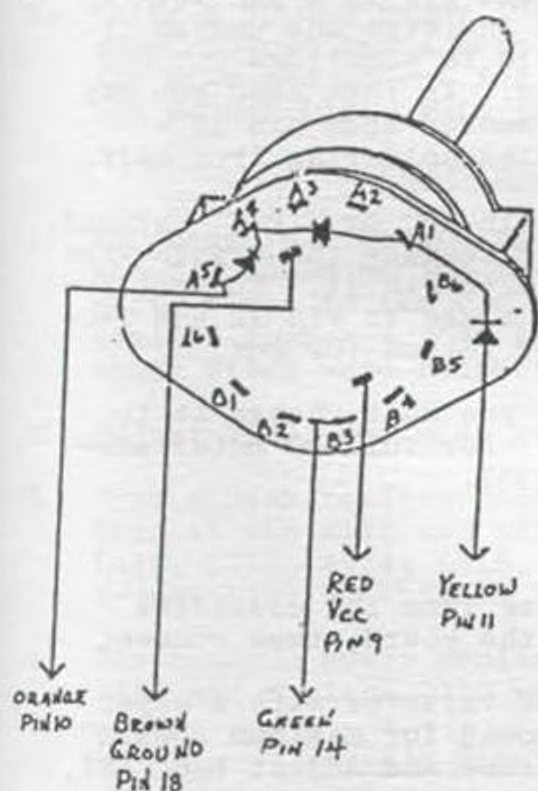



1. Locate the PLL chip MB8719 and cut away any circuit trace, if present, that would ground pin 10. In some cases it is a wire running under the chip between pin 10 & pin 18. In this case, very carefully unsolder the wire and unwrap it from pin 18 and clip it off. Pin 10 is sometimes cut off so it does not go through the board. In this case you may connect the lead to the wire you removed from pin 18 - use a grounded temperature controlled soldering iron only.
2. Connect the brown wire to wire to Pin 18, or P/C ground. Connect the red wire to VCC Pin 9. Connect the orange wire to Pin 10. Connect the yellow wire to Pin 11. Connect the green wire to Pin 12. Cut the P/C trace to Pin 12 and isolate. Then install a 4.7K resistor across the cut.
3. If your radio uses a 11.1125 xtal, you must change it to 11.3258 for coverage up to 28.045. For full 10 meter amateur coverage, change it to a 11.8391.

## SLIDE

Cut D36 & R187. Follow the red wire from the clarifier control to the P/C board and cut it at the board, then connect it to P/C board ground.

For maximum slide replace the stock varactor with a super diode or a super slide. CT3 may be removed for maximum upward slide. For xmitter tuning use 1000 Hz tone and Adjust L26, L27, L29, L36 for maximum peak power with a peak reading wattmeter. Adjust VR6, for AM power. VR7 is ALC. To increase AM & SSB power, cut the collector of TR32 and remove the 270pf (C102) cap from Pin #3 of IC3 to ground (AN612). Remove the resistor (270K-R84) in series with the wiper of the carrier balance, and install a 35K resistor or parallel the existing resistor with a 51K resistor. Check upper and lower sideband for AM. If present adjust VR5. All of the MB8719 radios are similar and the above instructions should work with small variations from chassis to chassis. Consult Secret CB volumes for the specific modification.

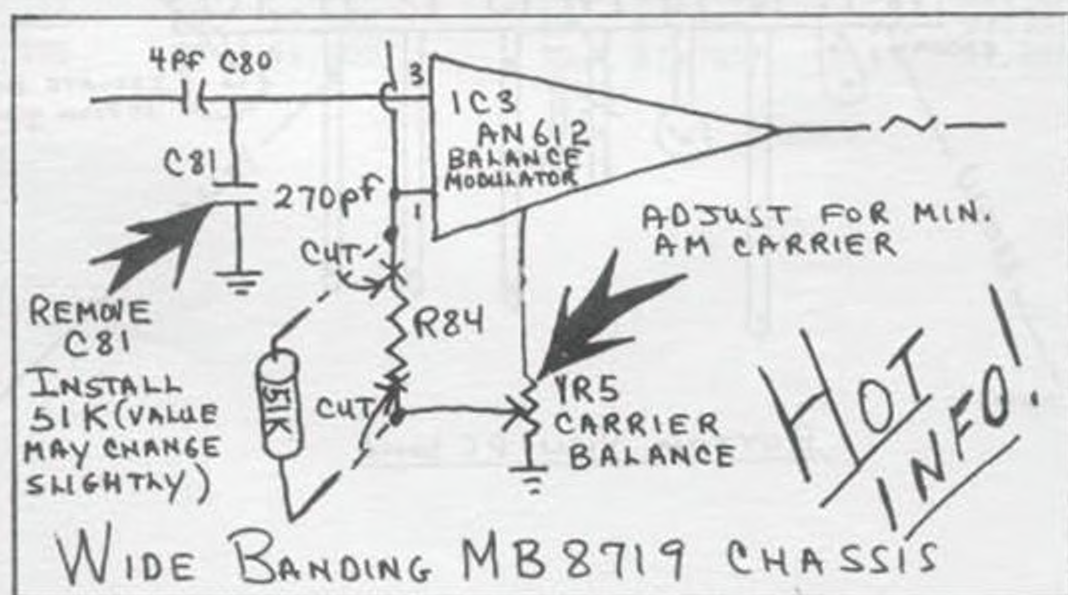



## SPECIFIC RADIO TUNE-UPS

### COBRA MODEL 19

1. Adjust VR6 for maximum modulation or cut VR6.
2. Using a 50 ohm dummy load (Secret CB's Little Dummy is a good choice) and a peak reading meter, insert 1000Hz to the mike and adjust for maximum peak out L11, L12, L15. Do not adjust L18. This is your TVI trap.

### FANON MODEL FANFARE 190DF

1. AMC Disable: Locate the AMC module. It is on the top of the P/C board behind the S-meter. Follow the brown and white wires to the P/C board and remove and tape back. Install a jumper across the two points where the brown and white wires were connected.
2. Adjust VR301 for mike gain.
3. With a peak reading meter and a dummy load insert 1000Hz tone at the mike and adjust for maximum peak at mid-band L112, L113, L114, L115, L116, L118, L119, L120. Do not adjust L121 as this is your TVI trap.
4. For maximum power replace Q109 with a 2SC1306 removed from Q110 and replace Q110 with a 1307.

### GENERAL ELECTRIC 3-5817A TUNE UP

1. AMC Defeat: Adjust RV2 or cut the collector of Q16.
2. With a peak reading wattmeter and a 50 ohm dummy load inject a 1000Hz tone into the mike. If you don't have a 1000Hz tone, whistle and adjust for maximum AM peak out, T2, T3, T4, L3. Don't be a dummy, use a dummy load for courtesy sake. Remember, if you adjust the set for over 100% modulation you cause distortion and bleed-over and bad TVI. Keep that modulation to 95%. Secret CB's Little Dummy is a good choice.

### JOHNSON MODEL MESSENGER 50

1. AMC Defeat: Adjust R49, or cut CR62.
2. With a 50ohm dummy load and a peak reading meter inject a 1000Hz tone into the mike. Tune for maximum output. Adjust T83, T84, T85, L84, L85, L86, L87.

### JOHNSON MODEL MESSENGER 80

(242-0080)

1. ALC Defeat, cut CR62.
2. With a peak reading wattmeter and a 50 ohm dummy load insert a 1000Hz tone into the mike and adjust for maximum AM peak, T132, T81, T83, T84, T85, L84, L85, L86, L87.



SPECIFIC RADIO TUNEUPS CONTINUED:

MIDLAND MODEL 150M

1. AMC Defeat RV201 or remove C213. Do not cut D204, D204, Q203, Q202, as this is for the receiver.
2. With a peak reading wattmeter and a good dummy load, inject a 1000Hz tone into the mike and adjust for peak power L301, L302, L303, L304, L305, L306.

MIDLAND MODEL 4001-(77-004)

1. AMC Defeat, adjust VR201 or cut collector of Q202.
2. With a peak reading wattmeter and a 50ohm dummy load, inject a 1000Hz tone into the mike and adjust for maximum power out L303, L302, L301, L304 (L305 not present in all sets), L306.

NDI MODEL PC-200

This looks to be a decent radio. It features a speech compressor and an exceptional noise limiter.

VR217 is the AM AMC or clip CR206, R207 AM power, SSB ALC R721.

With a 50ohm dummy load and a peak reading wattmeter, insert a 1000Hz tone in the mike and adjust for maximum AM peak power, L702, L704, L706, L709, T701, T702.

PACE MODEL 8193

1. AMC Defeat, adjust VR7 or clip the collector of Q16. SSB ALC VR11.
2. Connect the radio to a peak reading wattmeter and a 50ohm dummy load and inject a 1000Hz tone into the mike and adjust the AM for maximum peak reading, T8, T9, L4, L3, L2, L12.

PRESIDENT MODEL JAMES K (1015001)

1. AMC Defeat, cut D4.
2. Adjust for maximum AM peak with a 50 ohm dummy load and a peak reading meter while inserting 1000Hz into the mike, L3, L4, L15, L17. Do not adjust L20. This is the TVI trap.



SPECIFIC RADIO TUNEUPS CONTINUED:

REALISTIC MODEL TRC-425

1. AMC Disable, cut collector of Q509.
2. With a peak reading wattmeter and a 50ohm dummy load, adjust for maximum AM peak while injecting a 1000Hz tone into the mike, L804, L805, L806, L807, L901, L902, L905.

REALISTIC MODEL TRC-480(21-1563)

1. Adjust VR13 or cut collector of Q34. Adjust VR4 & VR5 for maximum SSB. AM power adjust VR14.
2. Using a 1000 Hz tone and a 50 ohm dummy load and a peak reading wattmeter, adjust at mid-band, T3-T4, T5, L7, L10, L11. Do not adjust TC2 as this is your 54MHz 2nd harmonic trap for TVI.

SEARS MODEL 663-38020800

1. AMC Defeat VR6 or cut collector of TR8.
2. With a 50ohm dummy load and a peak reading wattmeter adjust for maximum AM peak while injecting a 1000Hz tone into the mike at mid-band, L10, L11, L12, L15. Do not adjust L18 as this is your TVI trap.

Remember only dummies do not use a dummy load while tuning radios. It is discourteous, and illegal.

SEARS ROADTALKER MODEL 934-38260700

1. Locate the wire that goes to R711 and cut it off at the P/C board and connect it to P/C board ground. The wire that goes to the wiper or center terminal you do not disturb. Follow the other wire to the P/C board and cut at the board. Connect to Pin #3 of IC502(UA78C) voltage regulator. Short R701, cut R702. This will allow + 2KHz slide. For + 5KHz remove D702 (1S290) and install a super diode, available from Secret CB. For a simple bandsread, install a super 10 turn pot in place of VR701. This will allow ten turns where you used to have 3/4 of a turn on your stock pot.  
For AM power adjust RT01. Cut the collector of Q303 for AMC defeat. Adjust RT402 for SSB power.
2. With a 1000Hz tone, adjust T401, T402, T403, T404, T405, T407, T408 with a peak reading wattmeter into a dummy load for maximum peak reading.



SPECIFIC RADIO TUNEUPS CONTINUED:

SEARS MODEL 934-38270700

1. Cut R303
2. Cut R304
3. Short R302
4. Follow the black wire from the clarifier control and cut it loose from the chassis and connect it to ground. Follow the green wire from the clarifier control to the P/C board and connect it to the 8V regulated power supply, Pin #3 of IC601.
5. For maximum slide, remove D306 and D304 and install super diodes.
6. For more VCO range, D307 may be replaced with a super diode.
7. Adjust T302 for maximum RF output with a RF voltmeter or scope at the output of T302.
8. Adjust T301 for maximum RF output at the output of T301.
9. Adjust RT602 for AM power. Cut D405 for modulation. Adjust RT701 for SSB ALC. With a 1000Hz tone, adjust for AM peak with a peak reading meter. Adjust T701, T704, T702, T703, L704.

SEARS MODEL 934-38310700

1. Follow the green wire from the clarifier control to the P/C board and cut it loose from the P/C board and solder it to P/C board ground.
2. Short R701.
3. Cut R702
4. Follow the yellow wire from the control to the P/C board and cut it off at the board and connect it to Pin #2 of IC502 (UA78L82AWZ). Also connect a 100pf at 25VDC from Pin #2 to ground. This will allow approximately +2KHZ slide. For + 5KHz remove D702 (1S2790) and install a super diode. For more range from your control remove the clarifier control and install a super 10 turn pot in place of your stock control (RV701). This will allow 10 full turns range where your old control only had 3/4 of a turn.
5. With a peak reading wattmeter and 1000Hz tone on AM adjust T402, T403, T404, T405, T406, T407 for a maximum peak reading on the wattmeter.



## SPECIFIC RADIO TUNEUPS CONTINUED:

### Sears 934-38310700:

6. For AM power adjust RT301, for SSB ALC adjust RT402. For maximum AM modulation cut the collector of Q303 (AM AMC). Use a dummy load on all adjustments.

### SHARP MODEL CB 4670

1. AMC Defeat adjust R10 or cut the collector of Q101.
2. With a 50 ohm dummy load and a peak reading wattmeter, inject a 1000Hz tone into the mike and adjust for maximum peak output T203, T204, T301, T302, T303, T304, L301, L302.

### TRS CHALLENGER MODEL 850

1. AM mike gain, adjust VR1. AM power, adjust VR15. SSB ALC adjust VR8. SSB mike gain, adjust VR2.
2. With a peak reading wattmeter and a 50ohm dummy load inject a two tone signal, 1000Hz and 400 Hz into the mike. Adjust upper SSB for maximum RF, T10, CU3, T1, L1, L14, T2, T3. With a 1000Hz tone injected into the mike adjust L2 and L5 for peak AM power. Make adjustments with radio set at mid-band.

### TEABERRY MODEL STALKER III

1. AMC Disable, adjust VR8 or cut the collector of Q503.
2. Using a peak reading wattmeter and a 50 ohm dummy load, inject a 1000Hz tone into the mike and adjust for a peak AM output T804, T805, T806, T807, L901, L903, L905. Do not adjust F901 or you will be sorry as this is your TVI trap and will cause interference with TV sets.

### TEABERRY MODEL STALKER V

1. AMC Defeat, adjust VR4 or cut collector of TR18.
2. Using a peak reading meter and a 50 ohm dummy load, adjust for maximum AM peak output by injecting a 1000Hz tone into the mike, L21, L20, L17, L16, L14. Do not adjust L11. This is your TVI trap and messing with it is a NO - No.

### ROYCE MODEL 651 TUNE UP

1. AMC: Do not cut Q205 or C235, as on low power your mod. will be to hi and badly distorted. Adjust VR203 for low power and adjust VR202 for high power.
2. With a peak reading wattmeter & a 50 ohm dummy load inject a 1000 Hz tone into the mike & adjust for peak AM output, T502, T503, T301, T302, L303, C317, C319, C317.



## SPECIFIC RADIO TUNEUPS CONTINUED:

### TEABERRY MODEL STALKER XII

1. AMC Disable, adjust VR6 or D16.
2. With a peak reading wattmeter and a 50 ohm dummy load, inject a 1000Hz tone into the mike and adjust for maximum peak AM, L24, L25, L17, L16, L13. Do not touch L10 as this is your 54MHz TVI filter. This is factory adjusted to keep you out of your neighbor's TV set. In other words, keep your cotton-pickin hands off the goodies!

### HOW TO MAKE YOUR 858 CHASSIS SLIDE

The unidine 858 chassis: When we look at the print on the radio we see the voltage going to the varactor diodes D45, D41, D43 is switched in the transmit mode to a fixed voltage and the voltage in the receive is variable. What we must do is modify the radio to give us a variable voltage in the RX and TX mode. To do this we must remove all fixed transmit voltage from the circuit by cutting D30. Now we must apply constant voltage to the clarifier pot VR201. To do this we remove R119 and D32. R119 goes to the receive only voltage source and D32 is 5.90V. zener diode.

We then apply voltage to the clarifier by connecting a jumper from the + side of C135 to the + side of where D32 was removed. This applies 9150 volts in transmit and receive. By looking at the print we see R116, a 3.3Kohm, holds VR401 from ground, so we short R116 or remove the purple/white wire from the P/C board and move it to ground. R117 provides a constant voltage source to the varactors. This limits the amount of slide so we remove R117. To check our work we apply a voltmeter to the + side of the var. caps and we should have 0 volts to +, 9 volts on both TX and RX by varying VR401.

By removing the shunt caps CT6, Ct4, CT5 we allow more upward slide, and by removing D45, D41, D43, and installing super diodes and super slides you increase the slide up to 20Khz. By applying the principles here you can make any radio slide. Remember, you must remove all fixed voltages and apply variable voltages.

SEE TEN TURN POT APPLICATION TO SLIDE IN THIS ISSUE.

GOOD LUCK.

"SECRET CB" TELLS IT LIKE IT IS!!!!!!!!!!!!!!!!!!!!!!



## LINEAR AMPLIFIER NOTES

The single largest problem with home-built amps is poor layout and construction. The builder uses more wire than necessary in construction and does not lay out components close enough to each other. All control leads running through the RF deck should be shielded and by-passed. All filament leads must be by-passed with a capacitor across the filaments.

For grounding, the best method is to ground one side of the filament to the chassis. An additional capacitor will have to be installed on the filaments of each tube, keeping the length of the leads from the by-pass capacitor as short as possible. Screen by-passing is also equally important. For good practices and self-neutralization, do not allow screen filament leads to be in the RF components, as this will cause parasitics in the UHF region, T.V.I., and interference to other services. Remember, all filaments or screen straps must be low in inductance. This means you must use a wire with a large surface such as braiding or ribbon. All input and output leads must be shielded and separated from each other, to reduce parasitics or TVI and help neutralization.

Another important construction is the installation of the plate and screen supply fuse. Use fast-acting fuses in the plate and screen. Also your screen should be switched off and on with your antenna relay. Remember, never apply screen voltage before plate.

1. I use a relay with spare contacts for the plate supply and switch the screen with the plate supply.
2. A parasitic filter or choke installed in the plate lead at each tube will kill parasitics.
3. The resistor must be a noninductive approximately 25 ohms to 250 ohms.

A similar choke may be used in the grid leads to determine the correct amount of turn to use on the parasitic choke. Load the amp with the choke installed and shut the unit down. Ground the plate supply and check the temperature of the resistor. If it is getting hot this means you are absorbing some of the fundamental frequency and you must reduce the amount of turns on the choke until it doesn't heat up.



## MODIFICATION FOR SWAN SILTRONIX B,C,D RX AMP

The most common complaint of the owners of this popular rig is the poor ears. The solution for this problem is as follows: You must purchase a 326-2 RF amp kit. The amp is installed in a convenient place in the radio. Instal it on the top of the chassis on the shield panel between V5 & V1. I drilled a hole in the chassis to let the coax through, and to obtain power soldered the amp directly to the chassis, with the foil strip provided on the amp kit P/C board. Connect a 12" piece of wire #22 ga. from the power terminal on the amp board to pin 4 of V1. Connect 2 pieces of miniature coax to the input and output of the amp kit and run them through the hole drilled in the chassis. Locate the wire that runs from the relay to pin 1 V5 RX Rf amp 6CB6A and remove. Install the coax from the inside of the amp board to the relay. Keep leads short and ground the shield. Install the out lead of the amp to pin 1 of V5. The amp is now ready to use. Turn on power and align RX L701 & L801. If you want to switch the amp in and out use a relay to short the input to the output. Use short leads.

INSTALLING A GLEN LIVE RECEIVE & TRANSMIT F $\emptyset$  COUNTER ON A SILTRONIX 1011 BCD OR SWAN -

On the later models there is a VFO output jack on the radio, but on the earlier models you must install a VFO out jack. Use a miniature phone jack, non-shorting, and run a piece of miniature coax from the jack to pin one of V1 VFO amp. A 100 pf capacitor must be installed in series between the center conductor and pin 1. Shield must be grounded. Keep leads short. Install the phone jack in a convenient place on the back of the chassis. Connect a miniature phone plug to the coax supplied with the F $\emptyset$  counter and plug in. Now you must program the counter. Remove the top of the counter and look at the programming switches on the top of the counter board. Set the switch fo05500 for MHz or 55000 fo KHz display. To set, turn the stand-by switch to stand-by and set switch left to right with unit facing you and the pre-set will be displayed -0- all switches on and 5, 3 & 4 off. Turn on radio and you will have the Live F $\emptyset$  display on your counter in receive or xmit.

GLEN 326-G AS MODIFIED FOR USE AS A SIGNAL GENERATOR OR F $\emptyset$  COUNTER

First you must make up some special adaptors for this use. First you make up a preamp for low signals. Install a 326-2 amp in a small metal box with a RCA jack on each end. Use a miniature SPST switch and a 9v battery for power. Make up a cable with RCA male jacks on each end as a patch cord for use between the counter and the preamp. You must make up a cable to use as a sniffer, to plug into the amp. Cut a convenient length of coax and put a male RCA plug on one end and strip 2" of shield from the other end. Cover and insulate the place where you cut the shield off with heat shrink. Put a drop of silicon glue at the tip of the cable. This will insulate it. To use this cable



## GLEN 326-G MODIFICATION CONTINUED:

place it near the xtal or coil. No direct connection is necessary to read the F $\emptyset$  of the oscillator. Do not use a preamp on or near the PA amp as levels are too high and you will damage your counter. Another handy cable you will want is a loop pick-up. This can be used with scanners and other low RF outputs to read the oscillator's mixers or doublers in the receivers without direct connections or loading. Make up a cable with the male plug of a convenient length and wind 3 turns of #16 enameled copper wire on a  $\frac{1}{2}$ " coil form. I used the barrel of a ball point pen. You must not spread the loops.

Cut the leads short at the loops and connect the coax. Insulate with heat shrink. To use this probe slip the coil over the mixer coil interstage transformer or transistor and read the F $\emptyset$  without direct connection and without disturbing the circuit.

### HOW TO IMPROVE YOUR EL CHEAPO TRANSISTOR LINEAR AMP

One of the largest problems of the 12V transistor linear is that the unit is running full tilt or balls to the wall. To compensate for this you may pad the input and/or add one turn to the input transformer. They usually have 3 turns. Add one and install a 2w 10% resistor, 10 ohm to 60 ohm in series with the RF input to the transformer. This will pad the input and reduce the drive and allow the amp to have some breathing space by lowering the average drive. The average output will be lowered, thus on peaks the output will swing up instead of down. This will improve or eliminate the distorted sound you get up close.

### STANDBY POWER FOR EMERGENCY USE

1. If using a portable power plant, be sure to ground the power plant frame to a ground rod or other ground source in the power plant. One end is to be connected to a house or other building. The outside power source or the main breakers must be disconnected or you will apply power out over the line and possibly electrocute a power company serviceman.
2. If you use battery power you must use a box or container. A marine battery holder is the best. Remember, a battery holds approximately 2 gallons of electrolyte which is sulfuric acid, and batteries generate fumes which will explode if a spark or fire is near, so use extreme caution. Use the right wire size for the amount of current to be used.



## ECHO BOX SPEECH PROCESSING FOR TRC-449

The biggest complaint about the TRC-449 is the din mike plug, so I removed the jack from the chassis and installed a 4-pin mike jack on the radio. This matched the Tweety Bird Echo Box and all of the other mikes that I have. The din plug was removed from the mike and replaced with a 4-pin plug and wire to match. With the installation of the Echo Box in line and proper adjustment, my SSB reports were very good. With the on in heavy QRM I could be pulled out, but with it off, no luck. Remember, don't make it sound like you are in a barrel. Adjust it so your meter just stays up and does not fall off with your voice. This is much cheaper than RF voice processors and I think it is just as good, if not better. Good luck.

P.S. If you sound like you're in a barrel, no one will talk to you. They will think you are a AM-er.

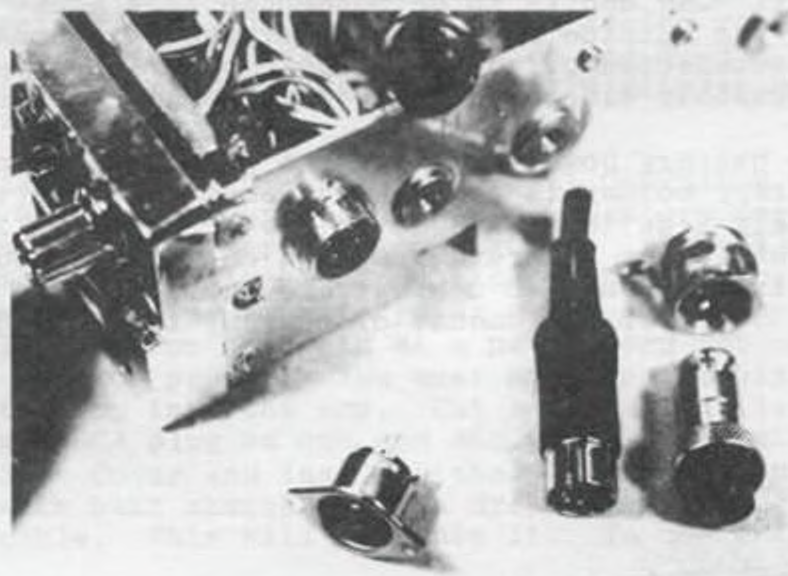
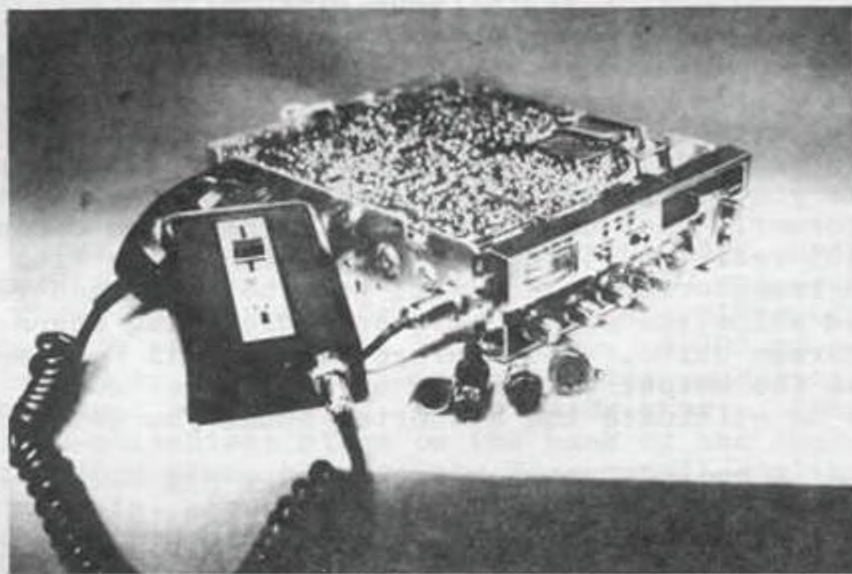



## ADDING PING

ADDING TB-2 MODULE  
TO MAKE RADIO "PING" LIKE GOLDEN EAGLE

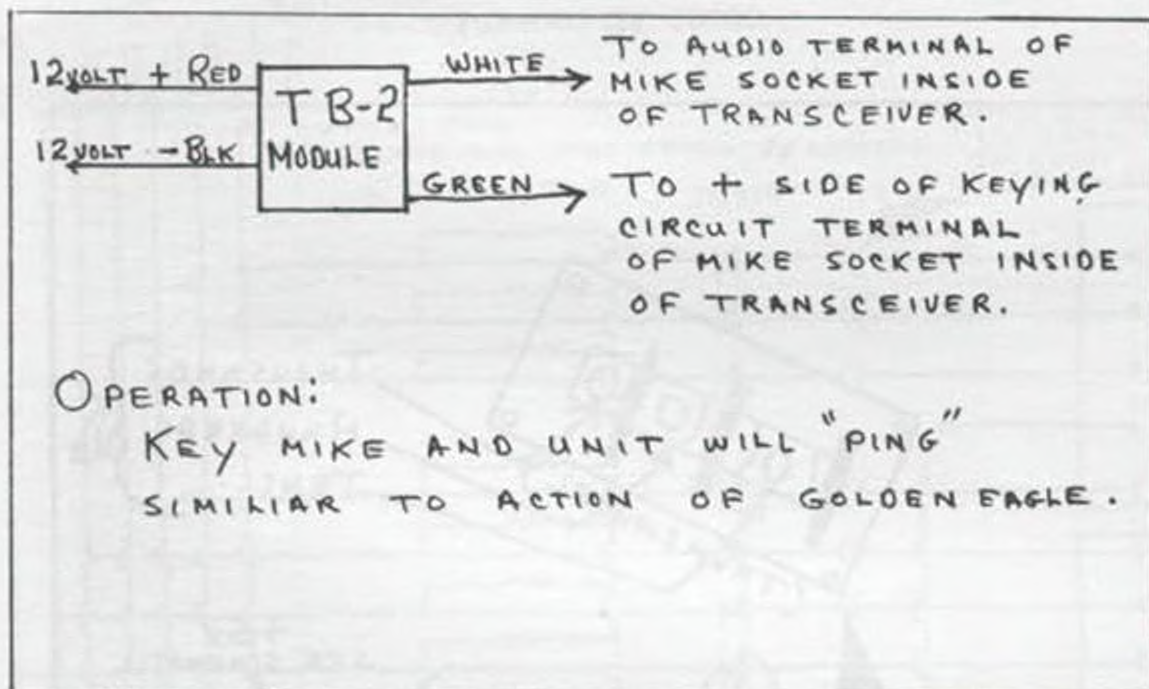

D&J Electronics, Inc. has brought back the ping because of the many requests for this popular unit. The simple installation of the unit allows a ping similar to the ping the Golden Eagle produced. A toggle switch in the power line to the module will allow the user to turn it off and on.

IN SOME CASES, TRANSCEIVER'S KEY SWITCHES VOLTAGES OR DOES NOT GO TO GROUND. A SIMPLE SPST RELAY MUST BE ADDED IN GREEN WIRE CIRCUIT AS

DIAGRAMED BELOW:

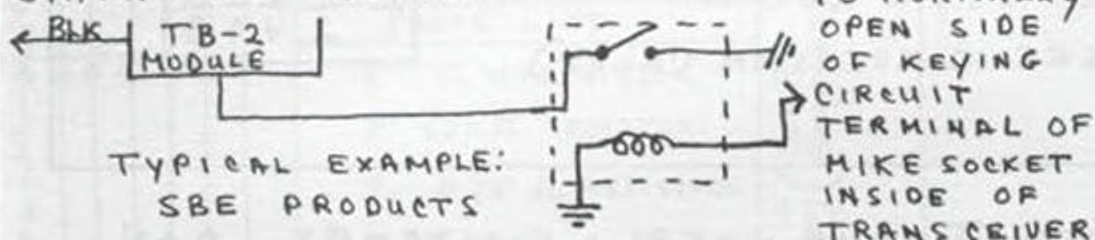

If you desire to use a (9) volt battery for your power source, be sure you have common ground to audio circuit & it is advisable to install a simple on-off switch in (+) power supply lead to eliminate battery drain when transceiver is turned off.

OPTIONAL CIRCUIT



THUMBWHEEL 200 CHANNEL CONVERSION  
AS APPLIED TO 858 CHASSIS

OOPS! WE GOOFED!

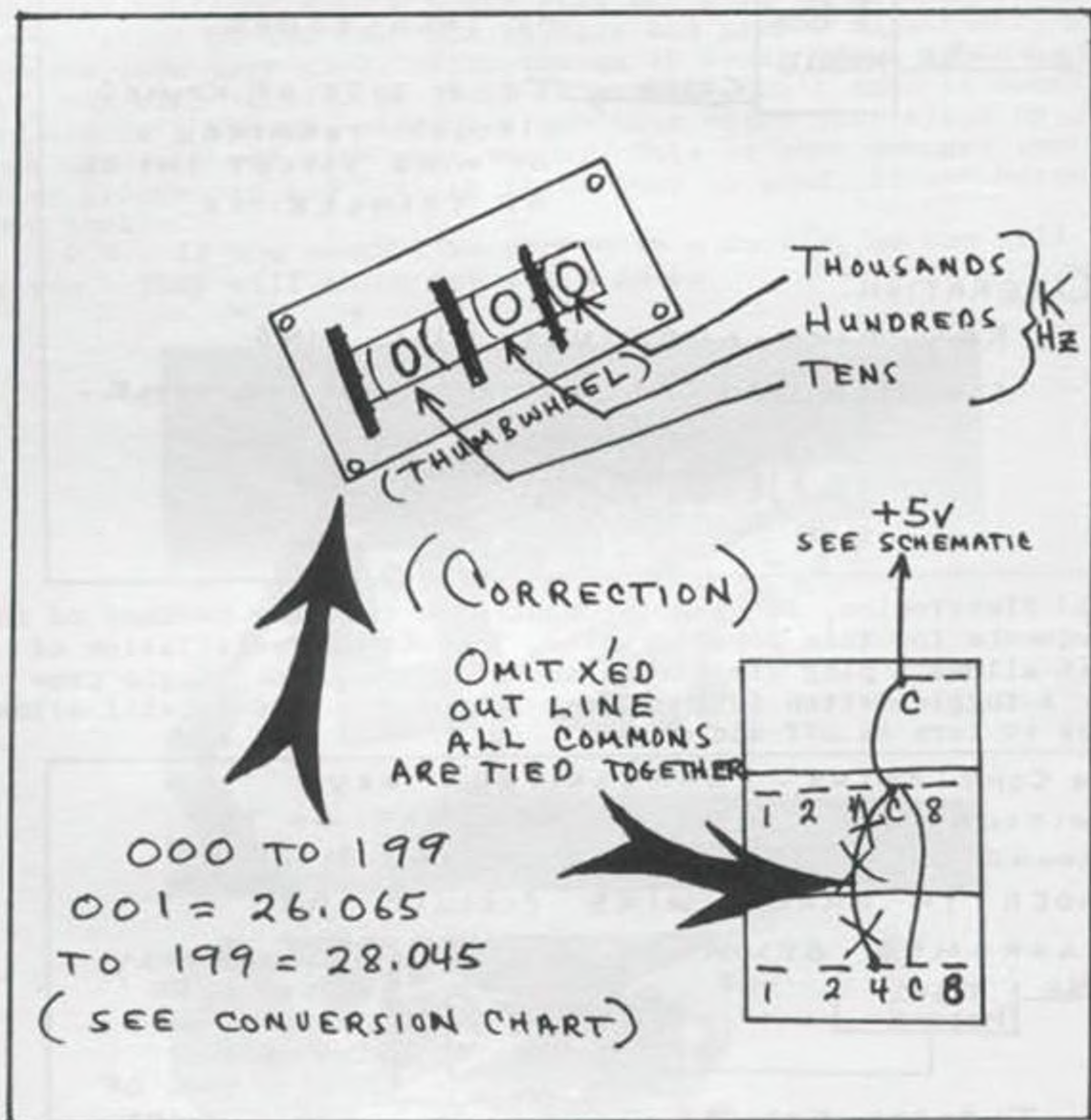

NOTE: THUMB WHEEL SWITCHES CAN  
SOMETIMES BE FOUND SURPLUS.  
SURPLUS THIS SWITCH WAS \$8.50.  
NEW THEY RUN AROUND \$17 TO \$20 APPROX.

THIS MOD. IS NOT AS HARD AS IT LOOKS!



OOPS! WE GOOFED!  
 200 CHANNEL CONVERSION  
 TO UNIDEN 858 PLL  
 26.085 TO 28.045

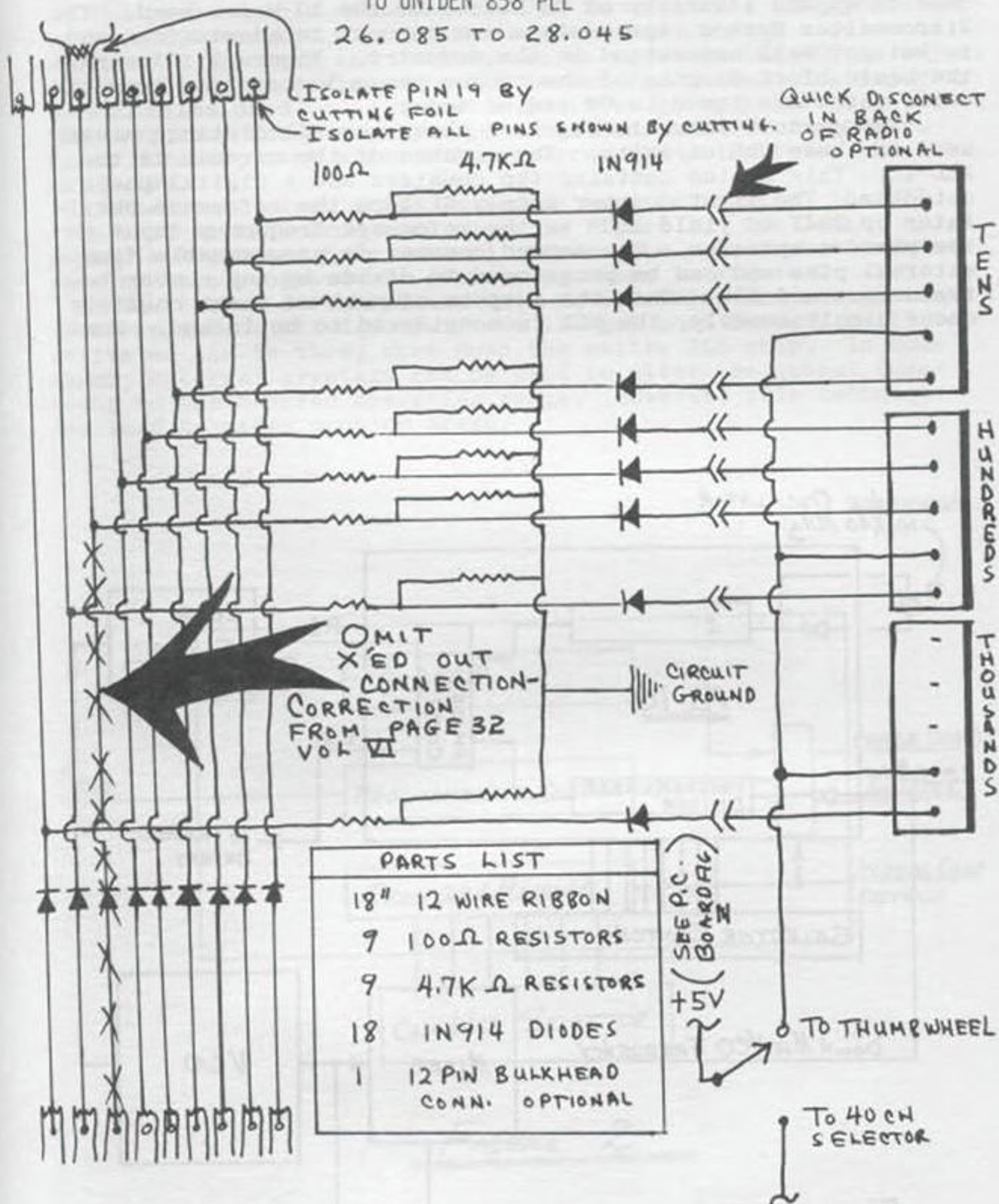

PARTS LIST	
18"	12 WIRE RIBBON
9	100Ω RESISTORS
9	4.7KΩ RESISTORS
18	IN914 DIODES
1	12 PIN BULKHEAD CONN. OPTIONAL



## MICROMONITOR TECH NOTES

Volume V introduced a new product, the Micromonitor, to be used to expand a variety of CB Radios to the 10 Meter band. The Micromonitor System represents a new concept in adaptations and is not yet well understood in the industry. Figure 1 illustrates the basic block diagram of the common phase locked loop type circuits which are found in CB radios today.

The circuit shown in figure 1 shows several distinct areas used in these PLL circuits. The essence of the circuit is the PLL IC. This device contains two counters and a digital phase detector. The first counter simply divides the reference oscillator by 2048 to yield 5KHz as the reference frequency input to the phase comparator. The second counter is programmable from external pins and can be programmed to divide by any number between zero and 256. When the outputs of each of these counters occur simultaneously, the PLL is considered to be locked. How-

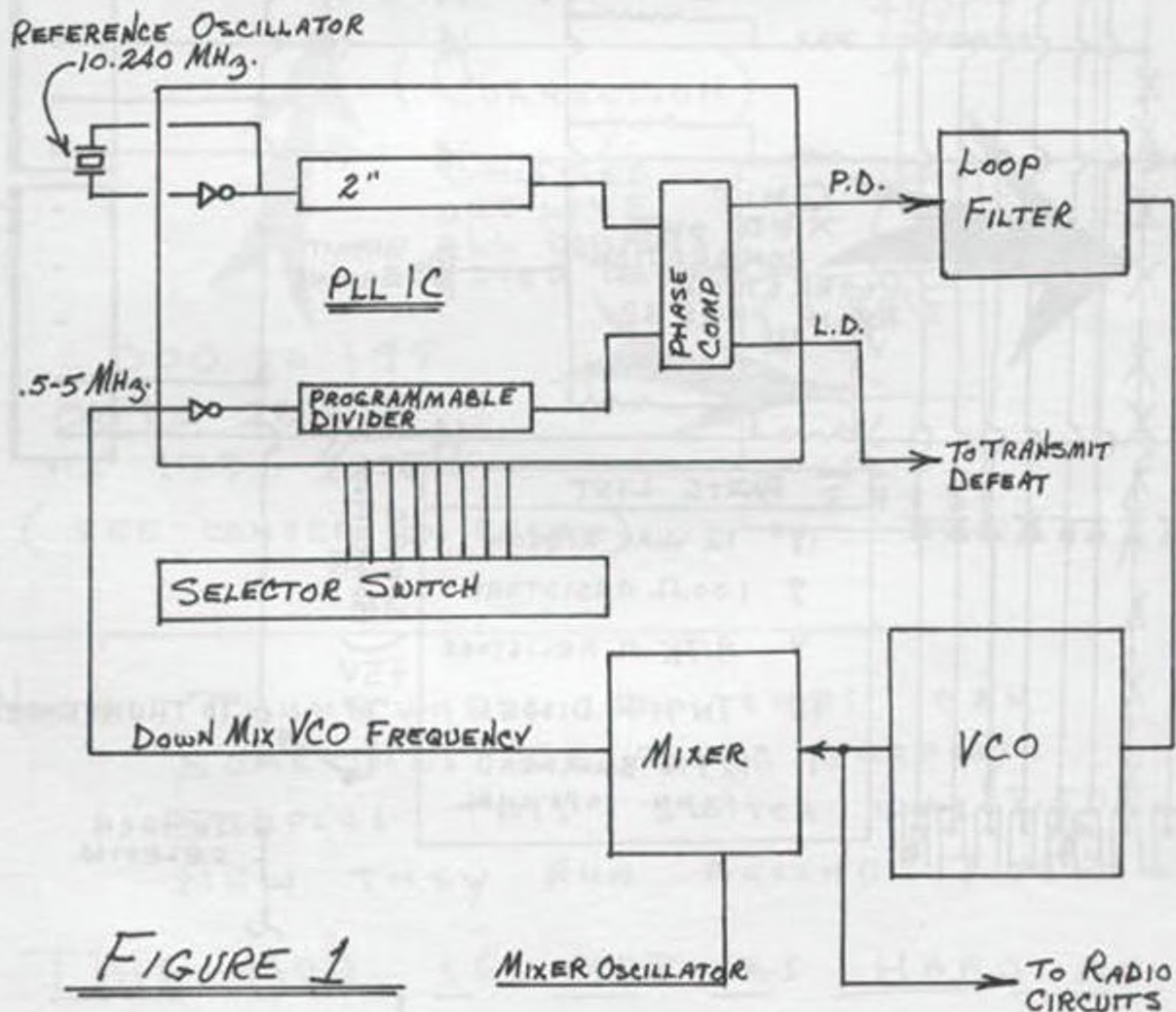

FIGURE 1



ever, when the reference counter output lags or leads the output of the programmable divider, the PLL is unlocked. The phase comparator detects the difference in phase and outputs a pulse of the proper polarity and duration so as to cause the VCO to adjust its frequency to again achieve a locked condition. The majority of PLL chips used today output a positive going pulse to increase VCO frequency and a negative pulse to decrease VCO frequency. Note, however, that a few chips reverse the polarity of the output pulse.

When the latest style CB radios were introduced, the PLL IC's used deviate from that shown in figure 1. The latest chips employ a ROM (read only memory) between the selector switch inputs and the programmable divider as shown in Figure 2.

When these new chips are used in CB radios and conversion is attempted, a third output, the illegal code detector will be activated and in turn, shut down the entire PLL chip. In some cases, external crystals can be used to alter the output frequency to the desired operating range. However, this technique can lead to other problem areas.

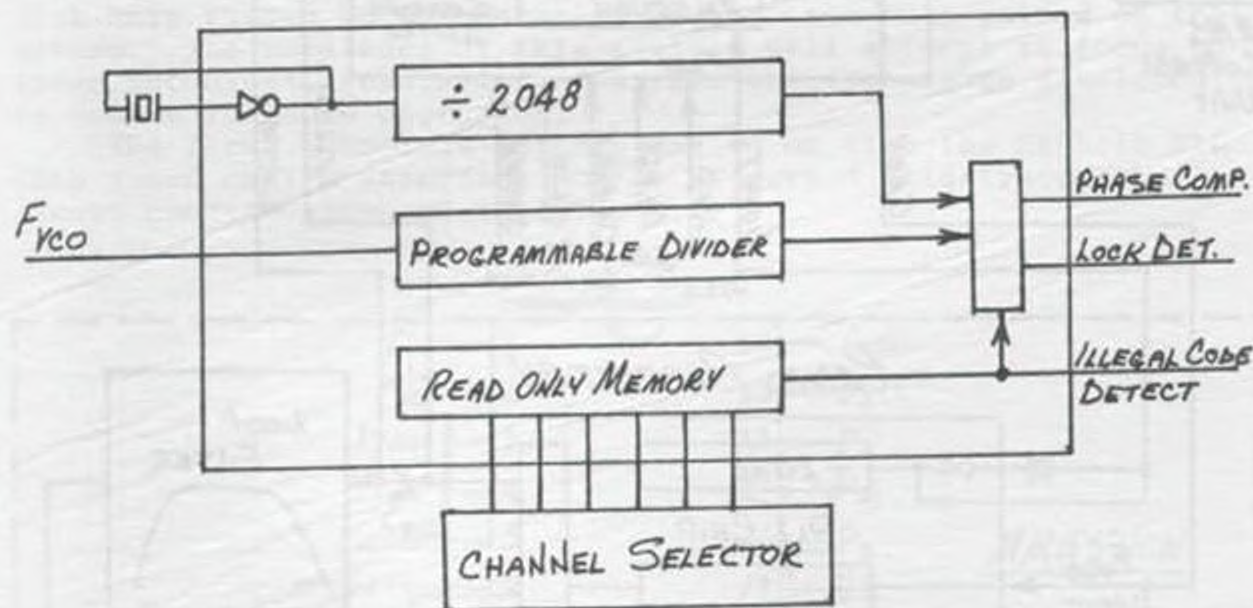
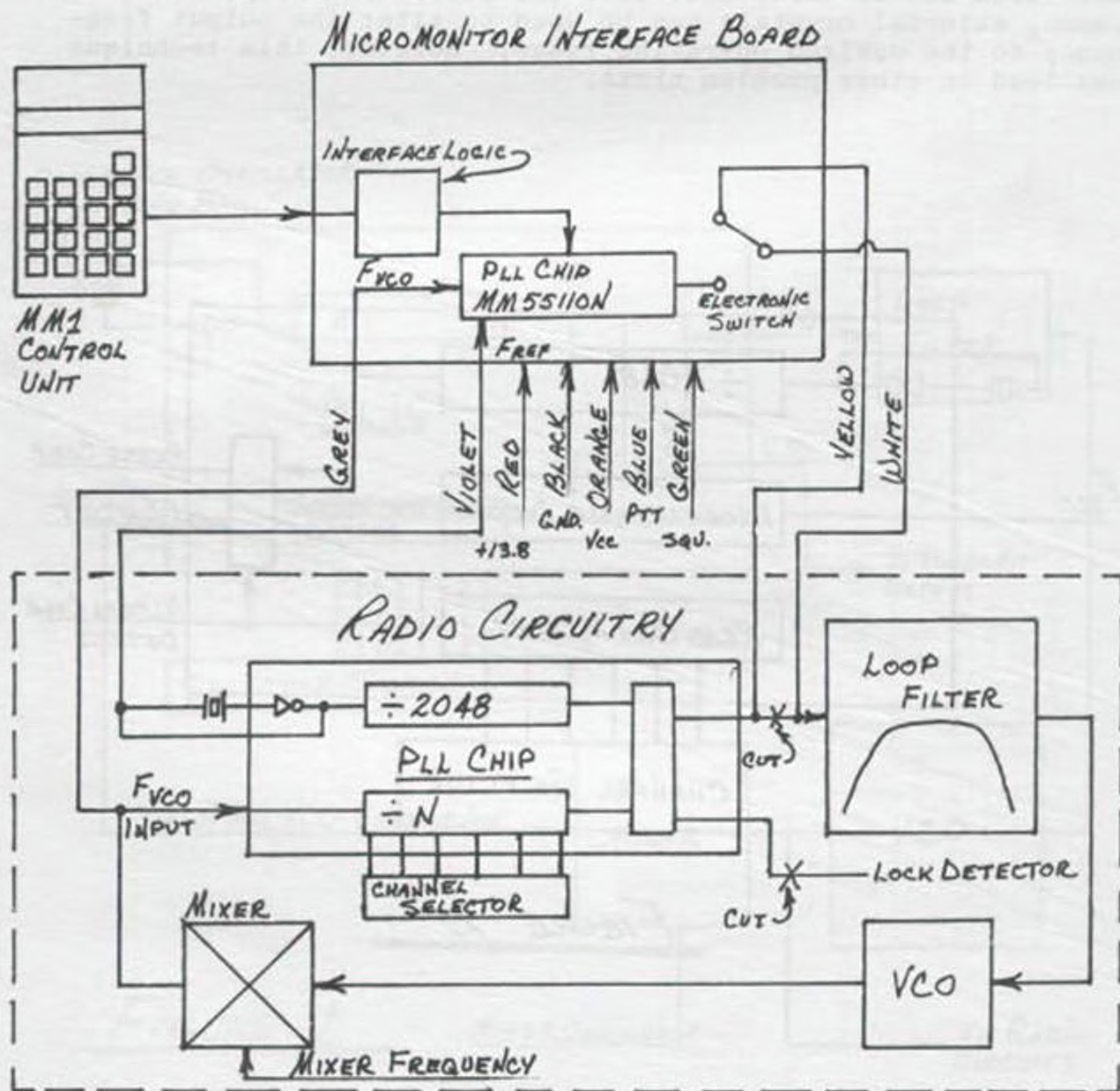

FIGURE 2



The Micromonitor System was designed to allow NORMAL radio operation using whatever type of PLL IC the radio designers have chosen to use and, when the 10 Meter use is desired, to electronically switch the Micromonitor circuitry into operation. Figure 3 depicts the block diagram with the Micromonitor installed.

FIGURE 3-





When the Micromonitor system is installed, only two radio circuit changes are normally required; the lock detector circuit must be defeated and the phase detector output of the radio's PLL chip is interrupted. When the MM1 is installed, a variety of connections are required. The interface board contains low current CMOS circuits and uses about 20 ma of radio power. The connections should always start with the black wire (ground) and proceed following the instructions included with each unit. When the radio's phase comparator output is cut, attach the yellow wire to the PLL chip and the white wire to the trace that used to be connected to the PLL chip. During normal radio operation, the output signal from the radio is routed to the yellow wire on the interface board and is electronically switched to the white wire which delivers the signal right back to where it used to be connected. As a result of this signal flow, the radio can be used in exactly the same way as it was before the modification was installed. However, when the MM1 is plugged in and turned on, the electronic switch changes state and now outputs a signal from the MM1 IC chip to control the VCO. As the reader can see, the best of both worlds can now be realized. The addition of the parallel PLL chip and the electronic switch allows the user the greatest flexibility possible in radio control.

The foregoing describes the principles of operation of the radio and Micromonitor designs, and, in practice generally works quite well. There are however, several anomalous modes that have turned up as operating history has been gained on the system. The remainder of this article will attempt to focus on these technical areas and to describe the techniques developed to assure reliable operation.

The first anomalous feature has to do with the MM55110 PLL chip found on the interface board. Figure 4 illustrates the pinout configuration of this IC.

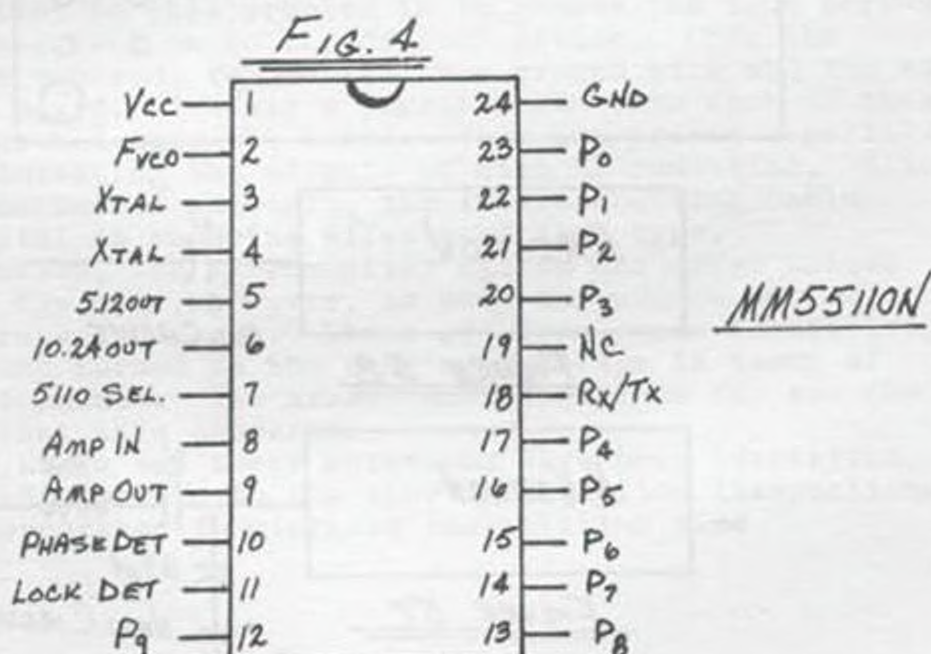



NOTICE that the Fvco input frequency connects to pin 2 of this device and also that the 10.240MHz reference oscillator appears on pin 3. These adjacent pins exhibit roughly 3-5pf of capacitance between them and as a result, some signal coupling exists between them. The effect of this coupling has been signal instability once installed in the radio.

The solution to this phenomenon is relatively simple: a 10k resistor and a small capacitor of about 39-50pf. Figure 5 illustrates the hookup of the filter.

This filter has been incorporated into the design and is now installed on all new units leaving the factory.

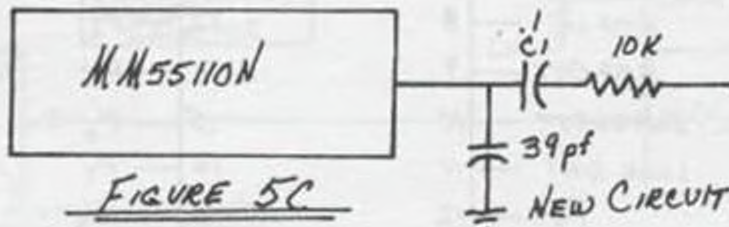
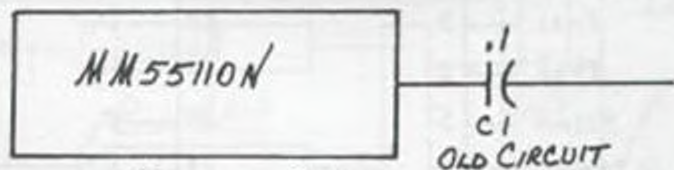
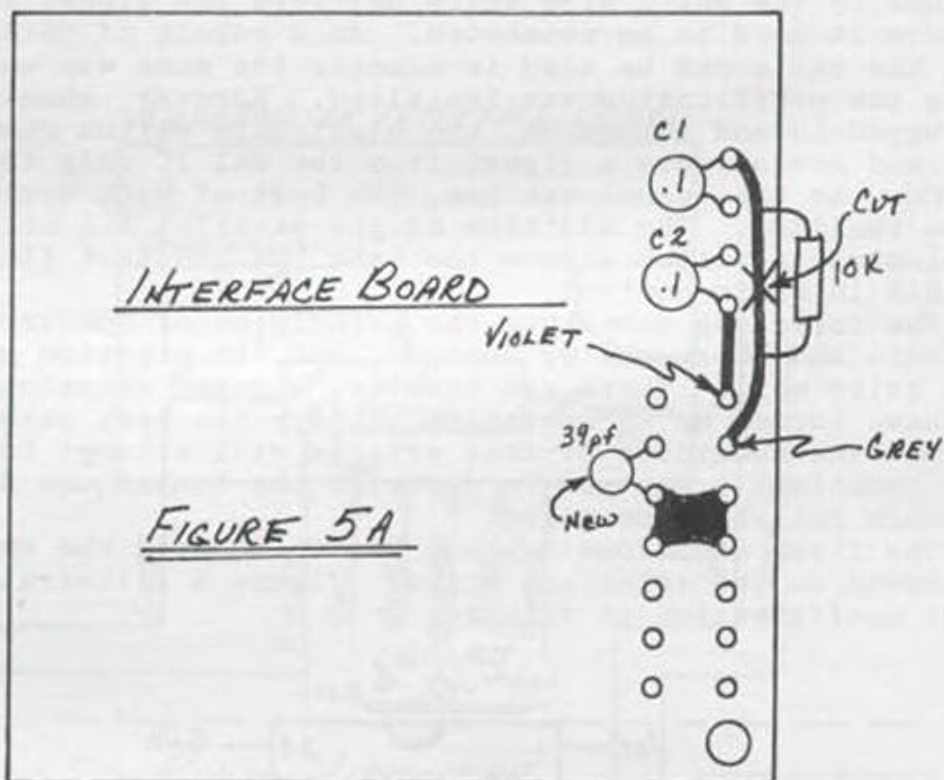



The second potential source of difficulty has to do with the Fvco input signal characteristics. The circuit requires a minimum of 1.5 volts peak to peak at all operating frequencies and, in addition, requires that each pulse be identical with each other. This translates to peaking up the VCO downmix signal at the mixer (see figure 3.).

In general, the higher the signal amplitude of this signal, the better the performance and, in turn, the corresponding operating range is increased. When the MM1 has been connected to CPI radios, experience has shown that some signal degradation exists when the radio is operated at the high end. Q615 is the Fvco mixer/amplifier for this stage. Simply rebiasing this stage will cure any instability problem. R626 is a 4.7k resistor in this radio. Substituting this resistor with a 2.2k (supplied) assures that the downmix VCO signal will perform adequately under all operating conditions. Similarly, the new UNIDEN chassis use two different down mix circuits, a one transistor design and a two transistor design. In the single transistor design, the collector-base feedback resistor (100K) may be increased to 470k to peak the signal. The two transistor design requires reducing the first transistor's base-to-ground resistor to 1k.

Of course each radio is slightly different, and, should instability be present, it is best to contact the factory for consultation. Note however, that these problems are not normally present. When they do occur, the technique is usually a very simple modification or adjustment that will allow full performance.

Lastly, some of the Micromonitor units exhibited a problem that showed up when RF amplifiers were used. The extremely high RF field caused by the linear amplifier was causing the Microcomputer to become unstable and the MM1 would exhibit a wierd display to signal this condition.

The solution to this problem is to remove the four screws holding the case back on to the control device. Once the board has been exposed, remove the bare ground wire and the red wire from the board. Install a ferrite bead onto each of these wires and reinstall into the board. This has proven especially helpful in eliminating the effects of high RF radiation. Alternately, some method of shielding the interconnecting cable should be helpful in reducing effects of this type.

In conclusion, the Micromonitor system can offer unique advantages to the user, however, as with any add-on device, troublesome areas can occur. These problems, once identified, can be cured and turned to the user's advantage in terms of increased performance. The areas identified thus far are the few problems that have appeared.

As these areas and their solutions have been identified, checkout and adjustments to the user installation instructions have been incorporated to minimize installation time.



# MICROMONITOR INSTALLATION INSTRUCTIONS

## RADIOS USING 858 CHIP

1. Verify supplied parts conform to list below:
  - 1 Tru-arc spring clamp
  - 1 Micromonitor
  - 1 Interface Board
  - 4 Spacers
  - 8 Screws (4-40x $\frac{1}{2}$ )
  - 1 LM340T-5 Voltage Regulator
  - 1 10k  $\frac{1}{4}$  watt resistor
2. Remove covers from radio.
3. Select a location to install interface board. Assure no interference exists when radio is reassembled.
4. Refer to figure. Install interface board and LM340T-5 regulator. Use heat sink compound.
5. Select a location for jack and punch  $\frac{1}{2}$  inch hole; file notch in hole so that jack can be secured.
6. Secure jack with Tru-arc spring.
7. Install jumper between pads 4 & 5 on interface board.
8. Cut traces connected to pins 1 & 2, 858 chip.
9. Cut trace connected to base of TR12. (see Fig. 2)
10. Install 10k resistor across trace just cut.
11. Ground trace previously connected to pin 1, 858 chip.
12. Cut wires to length and install as follows:
  - Red - +13.8 VDC (switched)
  - Orange - Pin 12, 858 chip
  - Black - Circuit ground at 858 chip.
  - Grey - Pin 11, 858 chip
  - Violet - Pin 10, 858 chip
  - Yellow - Pin 2, 858 chip
  - White - Trace previously connected to Pin 2, 858 chip.
  - Green - opposite end of 10k resistor connected to TR12.
  - Blue - 6.27 VDC transmit source at R196 (220 ohm)
13. Reassemble Unit.
14. Plug in MM1 - switch off.
15. Power on - cycle MM1 from off to on. "Ch19" should appear in display.
16. Verify xmt frequency of 27.185 MHz.



MICROMONITOR  
 INSTALLATION INSTRUCTIONS  
 RADIOS USING 858 CHIP

17. Depress 'HELP' button.
18. Verify XMT frequency of 27.065 MHz.

NOTE: Test points 1 & 2 are intended for amateur use only. Do not allow a short circuit to exist between these points for class D service.

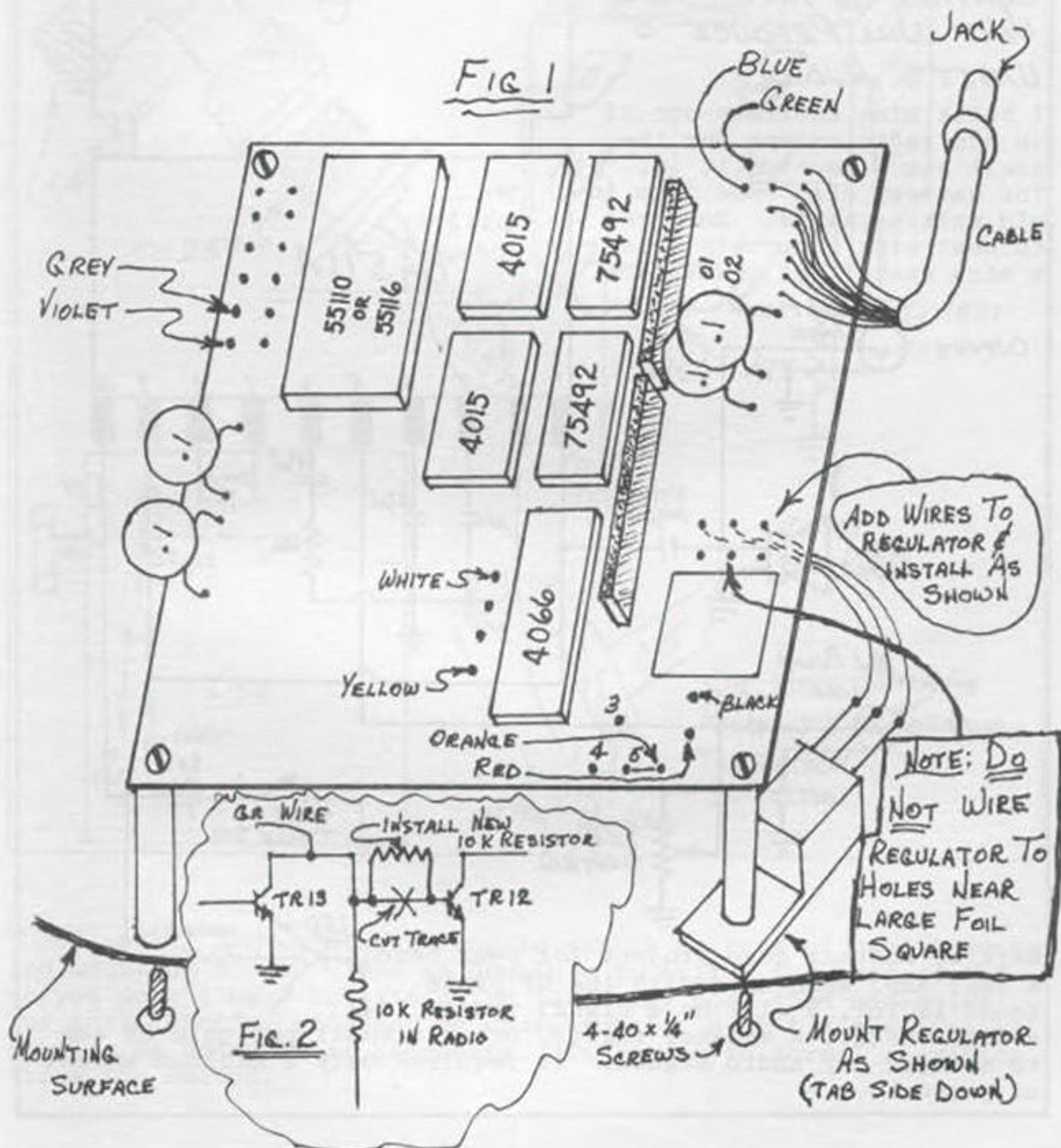



SECRET CB SAYS  
"You Can Build It"

## AMP FOR RF PROBE

USE AS A SIGNAL GENERATOR, CHECK MIKES, P.A. AMPS, ETC.

MOUNT IN SMALL BOX SUCH AS BUDD OR RADIO SHACK.

YOU MAY PUT VOLUME CONTROL ON INPUT. THIS UNIT WILL PRODUCE 5 WATTS AUDIO.

I built mine entirely out of an old radio except for the small box I mounted it in. The battery clip came from an old walkie-talkie. Be sure to heat sink your chip & use a mica washer for insulation.

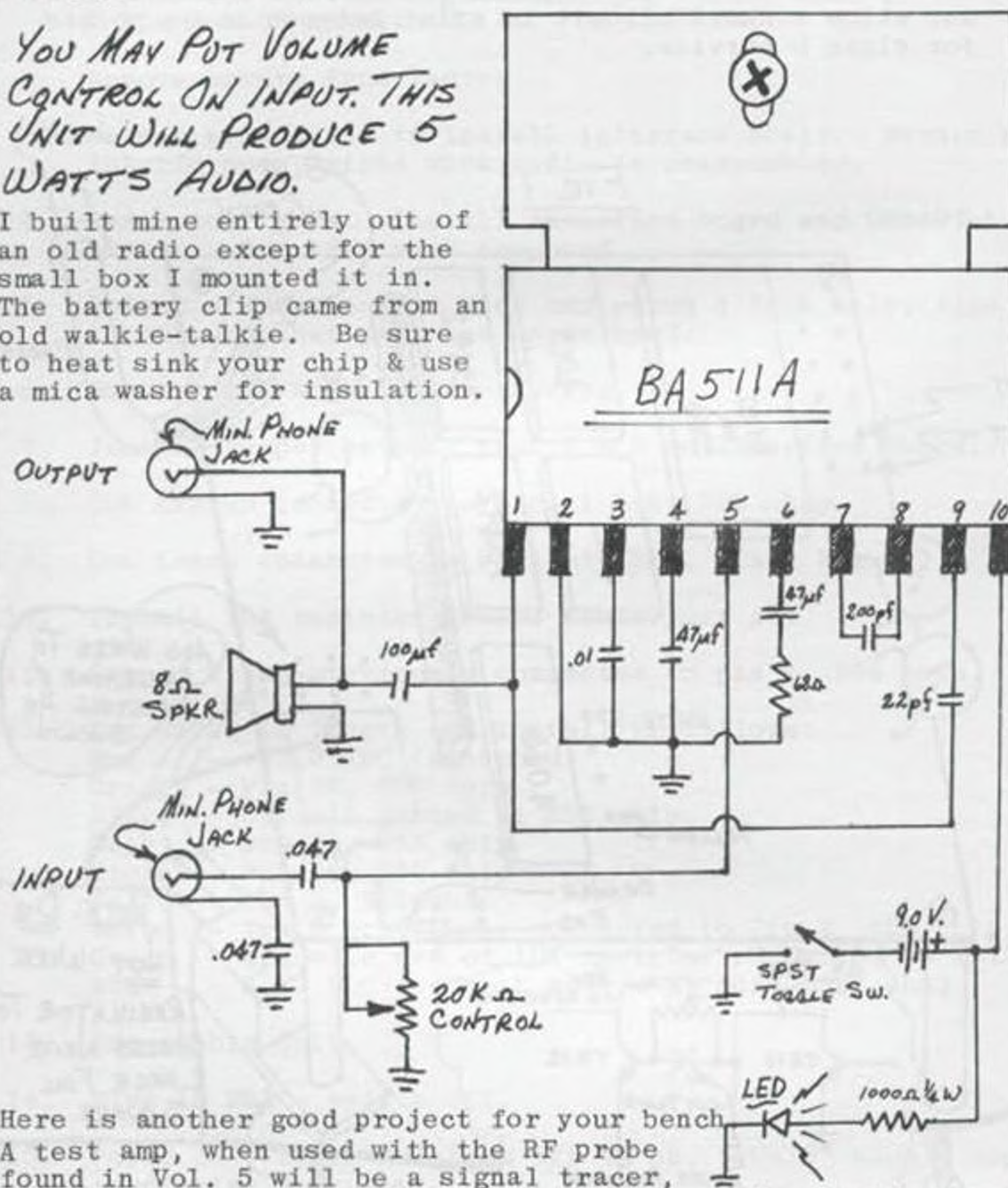

Here is another good project for your bench. A test amp, when used with the RF probe found in Vol. 5 will be a signal tracer, a mike tester, a speaker tester, or as a small portable 5W amp to monitor any audio signal. It requires only a minimum amount of parts.



# OSCILLOSCOPE MODIFICATION FOR RF & MODULATION DISPLAY

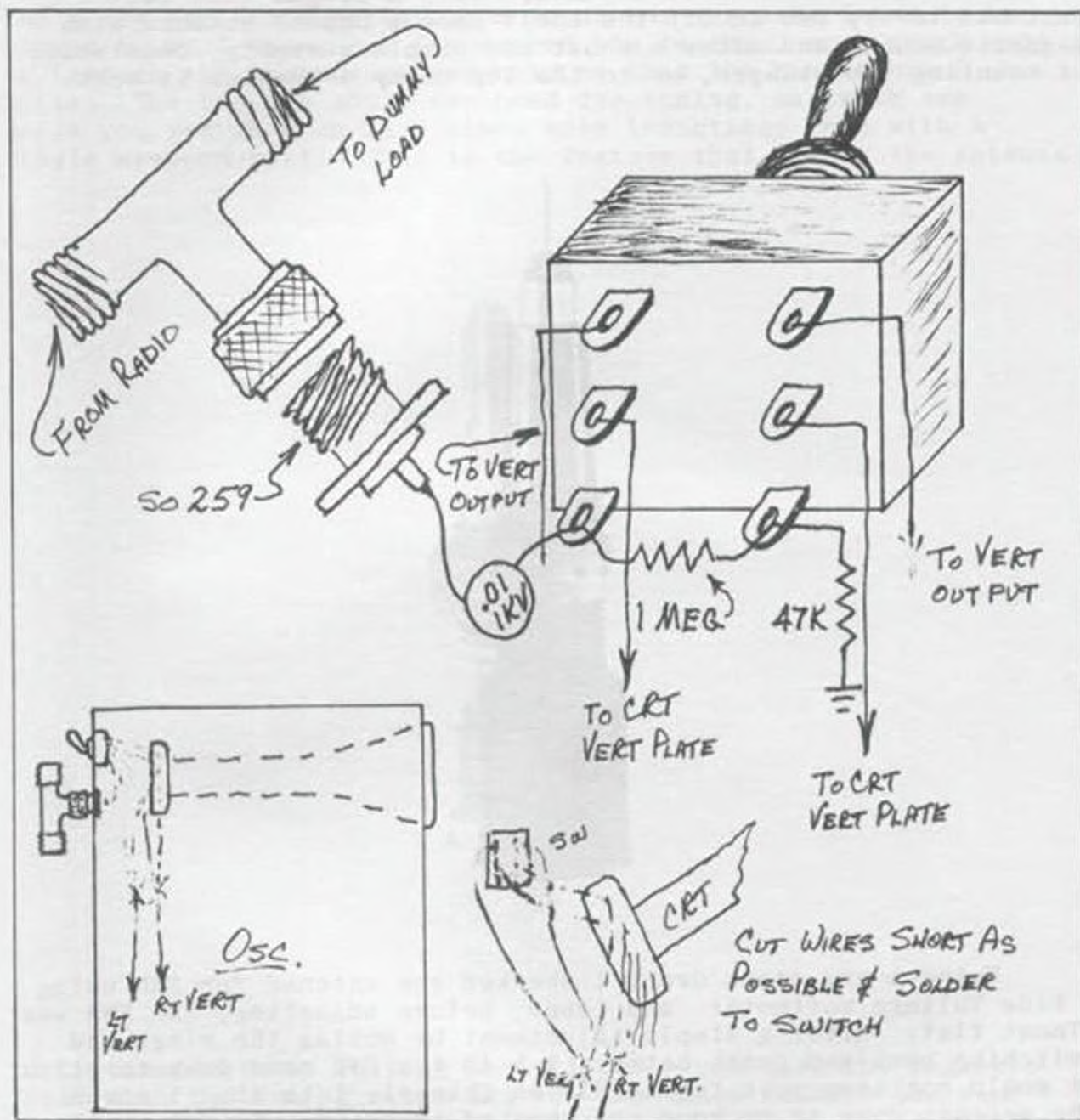

Install DPDT miniature toggle switch on back of oscilloscope and mount SO 259 as close as possible to switch and back of CRT so you do not have to extend the leads any more than necessary. The vert. cont's. will not be operational. Sync & Horizontal will need to be adjusted as necessary. To return to normal operation throw the switch.



## SECRET CB INTRODUCES

### "THE BANDIT"

"FOR STEALING A BETTER SIGNAL I AM THE BANDIT," boasts Lamtech, Inc.'s new microtron tuned antenna. With a slogan like that I just had to try one so off the shelf came a Bandit antenna with magnetic mount, and after a short and simple assembly, consisting of mounting the stinger, on to the top of my 4-wheeler it went.



Using a new stock Grant I checked the antenna for SWR using a Blue Vulture wattmeter and found, before adjusting, the SWR was almost flat. After a simple adjustment by moving the rings and switching back and forth between 1 & 40 the SWR came down to zilch. It would not even move the needle on Channels 1 to 40. I moved the antenna down to my hood and checked it again. It was still flat. Moving the antenna back to the top of my 4-wheeler and using a field strength meter I plotted a radiation pattern and found it to be almost round. With it on the hood I found that the radiation pattern was slightly shorter. But all in all it was as good - or in most cases better than - most of the other antennas I have checked.



## "THE BANDIT" CONTINUED:

Next the antenna went back on the roof and I started to check the RX and found it to be surprisingly less noisy than my K40. A lot of the static was gone so I mounted the K40 on the roof of my 4-wheeler and taking my field strength meter I plotted a new radiation pattern and found for the same I had to be closer to my 4-wheeler. I wondered how is this, so a quick call to Lamtech and their engineer told me that the bandit has 3 coils. The top two coils are used for tuning, and with two coils you get as much as 3 times more inductance than with a single wrapped coil. This is the feature that allows the antenna



to be tuned without cutting the stinger - you vary the magnetic field with the tuning rings and the impedance remains the same - 50 ohms. This is not the case with other antennas. The third coil is at the bottom of the antenna. This helps spread the RF over a larger area and provides a DC ground. This is what eliminates the noise or static in

The antenna is, I am told, rated at 100W. If you exceed this, you are in danger of melting the plastic at approximately 350W. But I checked the antenna at 200W with no ill effects.



## "THE BANDIT" CONTINUED:

After these checks the antenna was checked on another radio by a friend, with the same results, but he discovered that he could tune from 26.000 to 28.000 and not exceed 1.5:1 over the whole range! I found the coax could be cut to any length without effecting SWR. How about that?! You get a 10 day money back guarantee and 12 months on damage or workmanship. In other words, if you damage the antenna yourself, it is still guaranteed same as K40. But the only thing I didn't like about the antenna and K40 still has them beat, is the magnetic mount. It is too small. It would not stay on my 4-wheeler over rough country.

The antenna removal is good and the coax connector is super. Just screw it off. K40 is quicker and excellent. The other mounting methods are good also. You can mount the antenna on a stick or pole and it will match and work good. Results approach a Big Stick. When I tried K40 I had to cut approximately 14" off and match was still high.

Looks like Lamtech has a real winner. Hang in there and Good Luck.

### - ANOTHER EXCITING NEW PRODUCT RELEASE - EXPO 100 KIT

This small, compact unit is the answer for the people who have a Cobra AM radio such as the 29GTL or 87GTL or 21XLR. It also fits the new President AM's and many other manufacturers' AM radios.

Installation is simple. All you do is remove a capacitor and install the coax in its place, then hook up the power.

A complete line of EXPO kits are available for your particular radio from your favorite dealer or supplier.

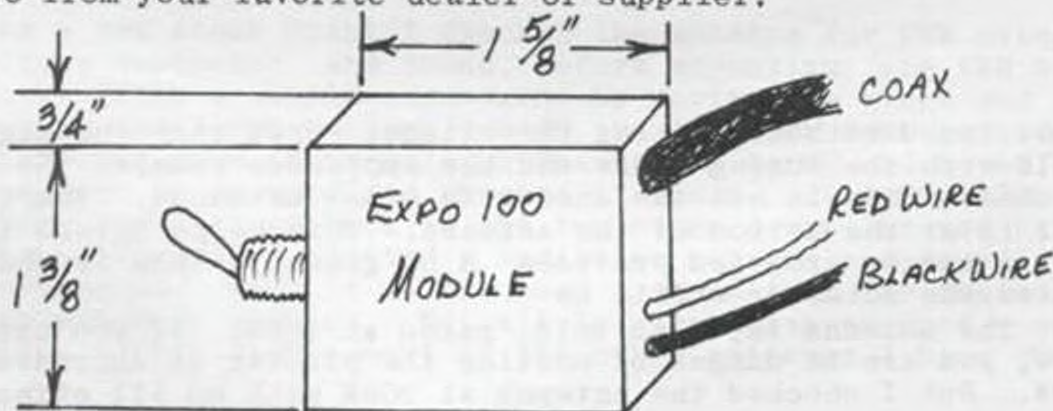



# NEW PRODUCT RELEASE

## SECRET CB'S OWN TROUBLE SHOOTER

Secret CB has outdone themselves on their new 20 mile simulator, shown with the Yaesu on the cover. This versatile test set allows the customer or technician to hook a radio up to it and observe how well it gets out under actual operating conditions.

All you need is one good radio and the radio you want to test. Connect the radios to the Trouble Shooter and talk. The test set simulates the radio's operation as it would sound 20 miles away. With the miniature receiver built into the test set you can listen to the test radio's operation independently of the receiving test radio.

For SSB radios there is also a built-in two-tone test generator that will allow you to adjust your radio with the addition of a wattmeter. This valuable feature will save you money on call backs. You can let your customer see how his repaired radio will perform before the set leaves the shop.

Information on these new trouble shooters is available from Secret CB.

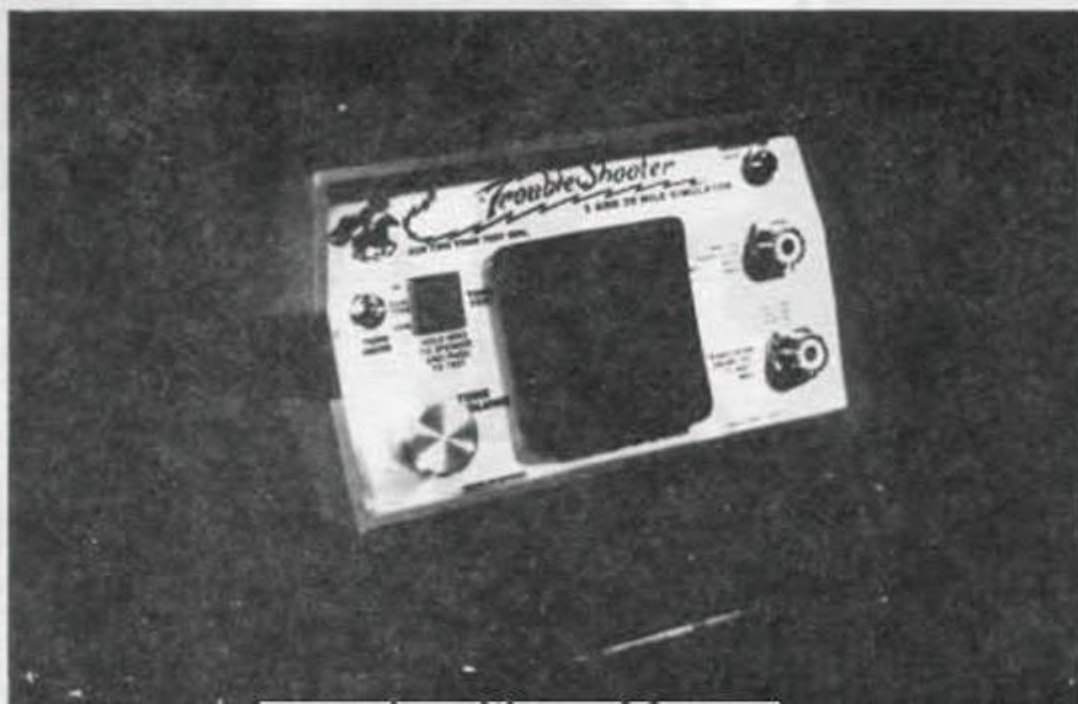



**SEE YOUR LOCAL CB DEALER  
OR ORDER DIRECT**

# SECRET CB ORDER FORM



Volume I



Volume II



Volume III



Volume IV



Volume V



Volume VI



Volume VII

SELMAN ENTERPRISES, INC.  
P. O. Box 8189  
Corpus Christi, Texas 78412

- |   |  |
|---|--|
| <input type="checkbox"/> \$12.95 Vol. I   | <input type="checkbox"/> 12.95 Vol. IV   |
| <input type="checkbox"/> \$12.95 Vol. II  | <input type="checkbox"/> \$12.95 Vol. V  |
| <input type="checkbox"/> \$12.95 Vol. III | <input type="checkbox"/> \$12.95 Vol. VI |
| <input type="checkbox"/> \$15.95 Vol. VII |  |

Phone 512 992-1303 If You Wish To Order By Phone.

SHIP TO:

Name \_\_\_\_\_

Address \_\_\_\_\_

City \_\_\_\_\_ State \_\_\_\_\_ Zip \_\_\_\_\_

Ship Via:  UPS  First class  Parcel post  Other \_\_\_\_\_

Send Check, M.O. or C.O.D. only. Add \$1.00 per book for shipping. Visa, Master Charge accepted. Add 3% for handling.



*For stealing  
a better signal...  
I am  
"THE BANDIT"*

B20 UNIVERSAL  
MINI-MOUNT

MODEL B61  
MINI-MOUNT

MODEL B30  
STATIONARY MOUNT

B50 WHIP &  
COIL ASSY.

MODEL B10  
MAGNAMOUNT

MODEL B60  
MAGNET PLATE

INSIDE VIEW OF "MICROTRON"™ COIL  
SO DIFFERENT WE'RE GETTING IT PAT.

 **LAMTECH, INC.**



# SECRET CB<sup>®</sup>

Special  
Index  
Issue

