

SECRET GB[®]



CONFIDENTIAL
**FACTUAL
 REPORT**
 SCHEMATICS ETC.
 UPDATED QUARTERLY

IMPORTANT; READ THIS FIRST

The information in this book is not to be used to exceed F.C.C. specifications, in any case, as applied to power, modulation, frequency spectrum, etc.. It is illegal to do this to any CLASS D RADIO.

This book is a factual report of gathered information, and as such is intended for use on radios for EXPORT ONLY.

If you are not familiar with electronics, it is better to check for advice with your local electronics or CB center, as to restrictions, etc., concerning your radio.

More information, on other units will be forthcoming in future issues, to be published on a quarterly basis.

This book will not be found at a book store, but can be obtained through your local CB Dealer or Distributor, or by sending \$15.95

To:

Secret CB

P. O. Box 8189

Corpus Christi, Texas 78412

Secret CB

Volume Six

Published August, 1979

Copyright 1979, All rights reserved in the United States and most foreign countries

New issues quarterly

Address any and all inquiries with return address to:

Selman Enterprises, Inc.
P. O. Box 8189
Corpus Christi, Texas 78412

(512) 853-2935

INTRODUCTION

Many thanks to all of you who read Secret CB. We appreciate all the letters and helpful hints. Starting with this issue, the donor of any helpful hints appearing in Secret CB will receive one free complimentary copy of the issue in which it appears. Please send a signed statement that we may use your information in any issue of Secret CB. Also any radio information that is similar we will acknowledge the one that is postdated first.

Now for some plain talk about these new 40 channel radios. The new Cobra GTL AM series radios will be difficult to modify. Specifically, Cobra 19 GTL, 21 GTL, 25 GTL, 89 GTL, and 1000 GTL. These are very fine radios but extensive modification will be required to modify these radios. Also any radios with similar chassis will produce the same results.

The Cobra 2000, President Grant, and Dak X seem to be some of the leading and most popular radios. These are single sideband radios and I am sure they speak for themselves.

Many techs do not understand that some radios are the same. Look carefully at the PLL sections and you will note many radios use the PLL O2A chip, although they might be under another brand name.

Keep the letters coming and thanks again for reading Secret CB!

Sincerely,

78's

Rod Johnson

TABLE OF CONTENTS

| | |
|---|-------|
| PHASE LOCK LOOP XTAL CROSS REFERENCE | 1- 2 |
| 11 METER CONVERSION FOR FT-901 | 3-12 |
| THINGS YOU CAN BUILD | |
| Test Tone | 13 |
| Signal Locator | 14 |
| Grounding your rig | 16-17 |
| SPECIFIC RADIO TUNE-UPS | |
| Audiovox MDU 6000 | 18 |
| Channel Master CB6 | 18 |
| Chrysler Models 4048706/8077 | 18 |
| Clarion TC-203E | 18 |
| Cobra 89/1000/87/148GTL and 78X | 18-19 |
| Colt 485/222 | 19-20 |
| Craig L102/L101 | 20 |
| Delco 80BCB2 | 20 |
| Fanon 10-40 | 20 |
| Gemtronics GTX-77/66 | 21 |
| General Electric 3-5814B/3-5804B | 21 |
| MODIFICATIONS | |
| 10-Turn POT | 22 |
| Kit for C.A.P. channels | 23 |
| OOPS, we goofed. Corrections on previous volumes. | 24 |
| Ranger T 4012 with MB8709 chip | 24-25 |
| Sears Roadtalker 40 | 26-27 |
| Golden Eagle Mark III | 28 |
| Browning Eagle IV | 29-30 |
| Thumbwheel 200 channel conversion | 31-34 |
| Pace 8092, Nesco 1249 and Halicrafters | 35-39 |
| REDCO APPLICATION AND TROUBLESHOOTING GUIDE | 40-52 |
| SPECIAL SECTION ON LINEAR AMPLIFIERS | 53-63 |
| SLIDE INFORMATION ON NEW CHASSIS, ETC. | |
| Application on new President Washington, McKinley, 140/142 GTL | 64 |
| Cybernet chassis slide as applied to some JC Penney, Sears Roadtalker | 65 |
| Super Clarifier Helpful Hints | 66 |
| MAKING THE PRESIDENT BASE WITH 8719 CHIP READOUT DIRECT EVEN IN RECEIVE MODE | 67 |
| NEW PRODUCT | |
| Secret CB looks at Redco's DX-50 signal master | 68-70 |

PHASE LOCK LOOP XTALS
CROSS REFERENCE GUIDE

HY-GAINS, MIDLAND 13-830, 13-857B, 13-882C, 13-888B and all other 23 channel radios with a Cybernet 02A chip. Replaces 11.806 xtal.

| | |
|-------------------|------------------------|
| XTAL 11.505 . . . | 26.065 thru 26.355 mhz |
| 11.605 . . . | 26.365 thru 26.655 mhz |
| 11.705 . . . | 26.665 thru 26.955 mhz |
| 11.905 . . . | 27.265 thru 27.555 mhz |

HY-GAIN II, PEARCE SIMPSON TIGER 40A and all other 40 channel radios with a Cybernet 02A chip and an 11.806 xtal. Replaces 11.806 xtal.

| | |
|-------------------|------------------------|
| XTAL 11.505 . . . | 26.065 thru 26.505 mhz |
| 11.655 . . . | 26.515 thru 26.955 mhz |
| 11.955 . . . | 27.415 thru 27.855 mhz |

COBRAS, TEABERRYS, REALISTICS, PRESIDENTS and all other 40 channel radios with a Uniden 858 chip and a 36.570 xtal. Replaces 36.570 xtal.

| | |
|-------------------|------------------------|
| XTAL 36.120 . . . | 26.515 thru 26.955 mhz |
| 37.020 . . . | 27.415 thru 27.855 mhz |

BROWNING BARON, COBRA 132 XLR, 135 XLR, TRAM D-62 and all other 40 channel radios with a TC5080P chip and a 17.056 or a 17.0555 xtal. Replaces 17.056 or 17.0555 xtal.

| | |
|-------------------|------------------------|
| XTAL 16.515 . . . | 26.065 thru 26.505 mhz |
| 16.815 . . . | 26.465 thru 26.905 mhz |
| 16.865 . . . | 26.565 thru 27.005 mhz |
| 17.265 . . . | 27.365 thru 27.805 mhz |
| 17.315 . . . | 27.465 thru 27.905 mhz |
| 17.365 . . . | 27.565 thru 28.005 mhz |

COBRA 140 GTL, 142 GTL, PRESIDENT McKINLEY, WASHINGTON, ADAMS, MIDLAND 78-900 and all other 40 channel radios with a Uniden 8719 chip and an 11.1125 xtal. Replaces 11.1125 xtal.

| | |
|-------------------|------------------------|
| XTAL 10.700 . . . | 25.725 thru 26.765 mhz |
| 10.850 . . . | 26.175 thru 26.615 mhz |
| 11.000 . . . | 26.625 thru 27.065 mhz |
| 11.250 . . . | 27.375 thru 27.815 mhz |
| 11.300 . . . | 27.525 thru 27.965 mhz |
| 11.400 . . . | 27.825 thru 28.265 mhz |

PHASE LOCK LOOP XTAL CROSS REFERENCE GUIDE CONTINUED:

COLTS, GEMTRONIX, GTX-77, G.E. SUPER BASE, SSB 3-5825A, 3-5875A, HY-GAIN V SSB, MIDLAND 78-892, 79-892, PALOMAR SSB 2900, RCA 14T302, SBE LCBS-4 and all other 40 channel radios with a Cybernet 02A chip and 1 10.0525 xtal. Replaces 10.0525 xtal.

| | | |
|------------------|--------------------|-----|
| XTAL 9.940 . . . | 26.515 thru 26.955 | mhz |
| 10.165 . . . | 27.425 thru 27.865 | mhz |

PRESIDENT GRANT, (NEW) COBRA 2000 GTL and all other 40 channel radios with a Uniden 8719 chip and an 11.325 or an 11.3258 xtal. Replaces 11.325 or 11.3258 xtal.

| | | |
|-------------------|--------------------|-----|
| XTAL 11.000 . . . | 25.995 thru 26.435 | mhz |
| 11.050 . . . | 26.145 thru 26.585 | mhz |
| 11.150 . . . | 26.445 thru 26.885 | mhz |
| 11.200 . . . | 26.595 thru 27.035 | mhz |
| 11.450 . . . | 27.345 thru 27.785 | mhz |
| 11.495 . . . | 27.475 thru 27.915 | mhz |
| 11.500 . . . | 27.495 thru 27.935 | mhz |
| 11.505 . . . | 27.505 thru 27.945 | mhz |
| 11.600 . . . | 27.795 thru 28.235 | mhz |
| 11.640 . . . | 27.915 thru 28.355 | mhz |
| 11.650 . . . | 27.945 thru 28.385 | mhz |

NOTE: Cobra AM GTL series radios will not track on receive by changing PLL xtal alone.

11 METER CONVERSION FOR FT-901

1 Order three crystals from your favorite parts place.

FREQUENCY #1 40.487500 MHZ (for 26.000 to 26.500 MHZ)
#2 40.987500 MHZ (for 26.500 to 27.000 MHZ)
#3 41.487500 MHZ (for 27.000 to 27.500 MHZ)
#4 41.987500 MHZ (for 27.500 to 28.000 MHZ)

Type HC-25/u

| | |
|-------------------------|--------------------------|
| 1-LOAD CAPACITANCE | 30pf |
| 2-SERIES RESISTANCE | 25 ohm or less |
| 3-STATIC CAPACITANCE | 7pf or less |
| 4-CALIBRATION TOLERANCE | .001 |
| 5-TEMPERATURE TOLERANCE | .003 from -30°C to +60°C |
| 6-AT CUT | |

NOTE: These factors are identical to the YAESU FT 101B crystals except for frequency.

2-Remove the top and bottom shell of unit. Install 40.4875 crystal where 10A crystal is, install 40.9875 where 10B is, install 41.4875 crystal where 10C is and install 41.9875 where 10D is.

Inside view of crystal box showing the installation of the new 11 meter crystals and the old crystals that were removed.

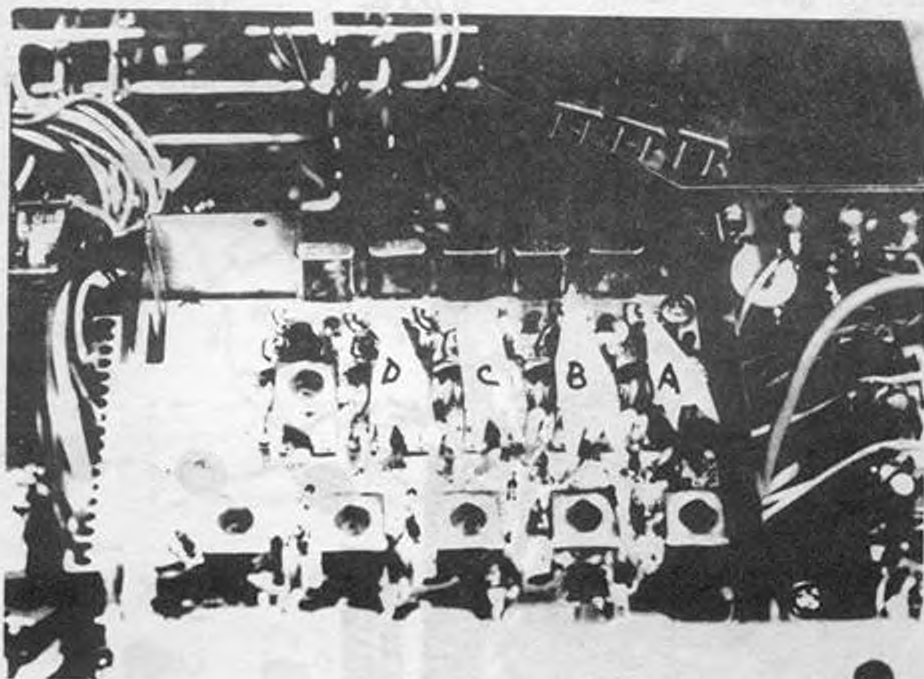

3-Connect a sensitive RF voltmeter or scope to pin #16 on the connector block in front of crystal box and put band switch to 10A and adjust the coil next to the 40.4875 crystal to maximum output on the voltmeter. Install cover to adjacent coils, then bare wire from pin #16 to connect probe.

This photo shows the coils that are to be adjusted and their placement.

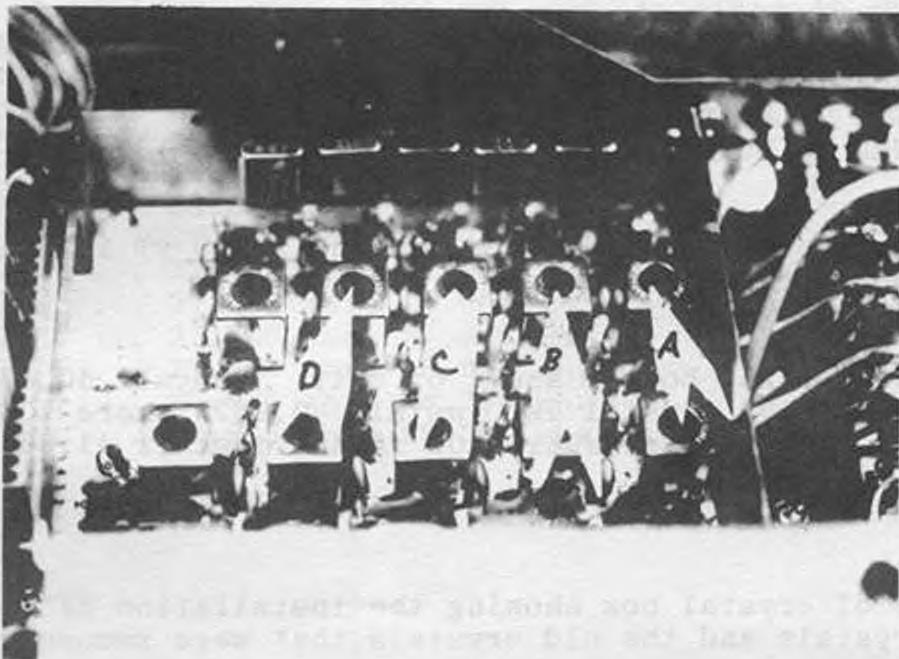

This photo shows the close-up view of pin #16 and the connection of the scope probe for the alignment of the coils.

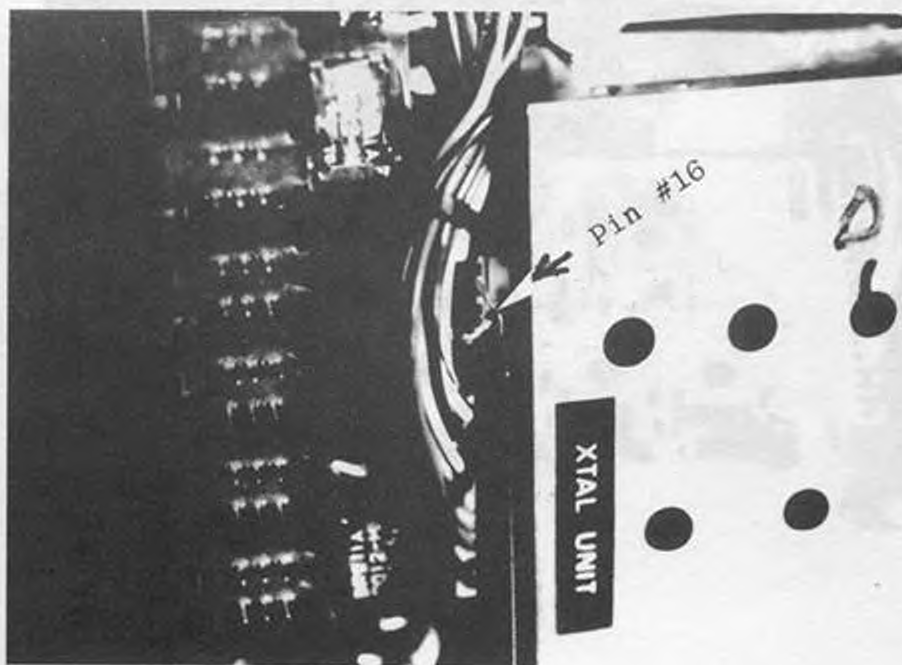

- 4-Remove counter box in back of display unit. The PLL unit must be removed first to allow the counter unit to be removed. Notice the colored wires soldered in the circuit board next to the two integrated circuits Y7 and Y4. Remove the blue, violet, grey, and white wires from the circuit board and re-connect them as shown, using silicon diodes in series.

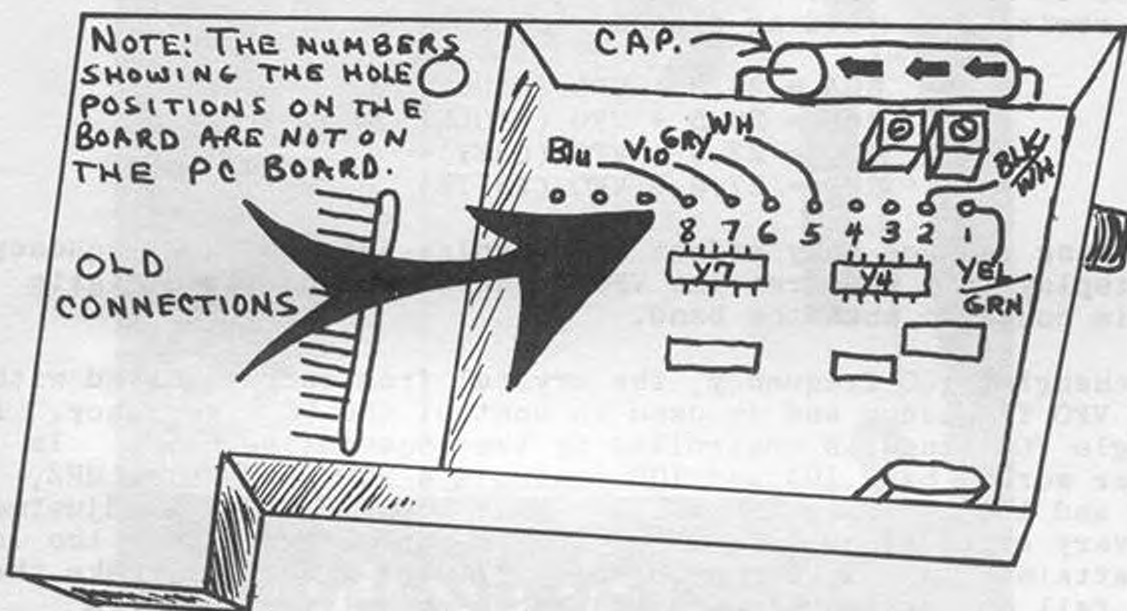

TOP VIEW INSIDE OF COUNTER BOX

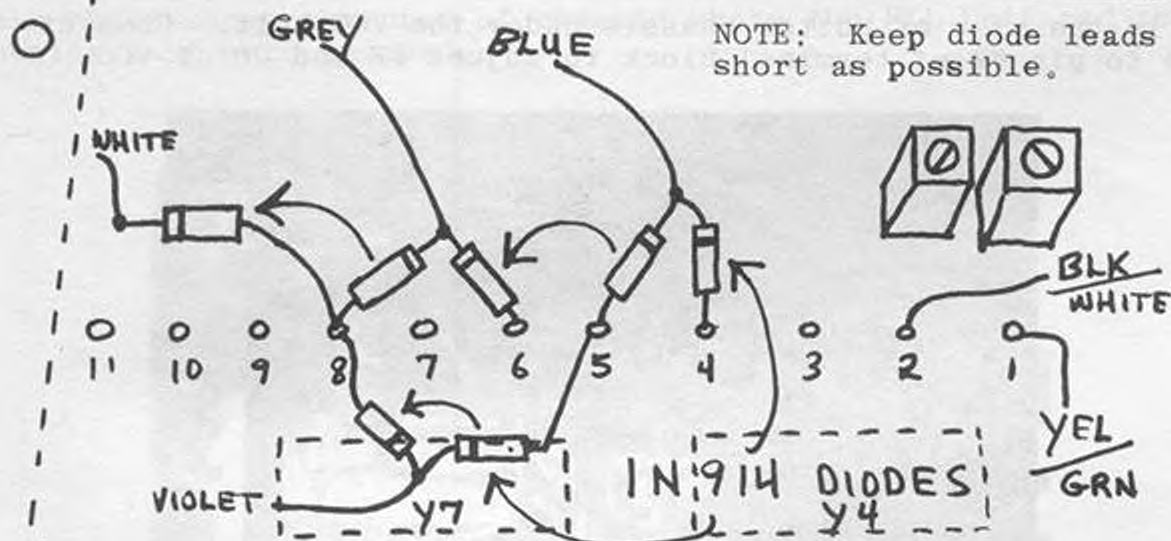

EXPLODED VIEW
NEW CONNECTIONS

As a note of interest these wires are switched to ground by the channel selector switch to change the left most three digits on the display. Only one wire is used for each position.

10A is the BLUE wire, 10B is VIOLET, 10C is GREY, and 10D is WHITE. Normally 10A is $28.0 + \text{VFO}$. 10B is $28.5 + \text{VFO}$, 10C is $29.0 + \text{VFO}$, and 10D is $29.5 + \text{VFO}$.

After rewiring and adding diodes, the new ranges are:

10A = $26.0 + \text{VFO}$ (BLUE)
10B = $26.5 + \text{VFO}$ (VIOLET)
10C = $27.0 + \text{VFO}$ (GREY)
10D = $27.5 + \text{VFO}$ (WHITE)

The wiring changes only effect the display and not the frequency. The display only measures the VFO frequency, adds three digits to this count to show the band.

5-In changing VCO frequency, the crystal frequency is mixed with the VFO frequency and is used to control the VCO frequency. A single VCO range is controlled by two consecutive bands. In other words, band 10A and 10B controls a VCO range of 1 MHz, 10C and 10D controls another range of 1 MHz. The VCO adjustment is very critical as lock frequency is approached. Once the lock is attained, an adjustment of only 1/10 of a turn may make the VCO fall out of adjustment, so proceed slowly. Connect a frequency counter of pin #2 on the plug under the chassis, directly under the VCO unit. (Do not remove cover of VCO). Place band switch to 10A and VFO dial to 000.

This is the view of bottom chassis under the VCO unit. Connect probe to pin #2 of terminal block to adjust AB and CD of VCO.

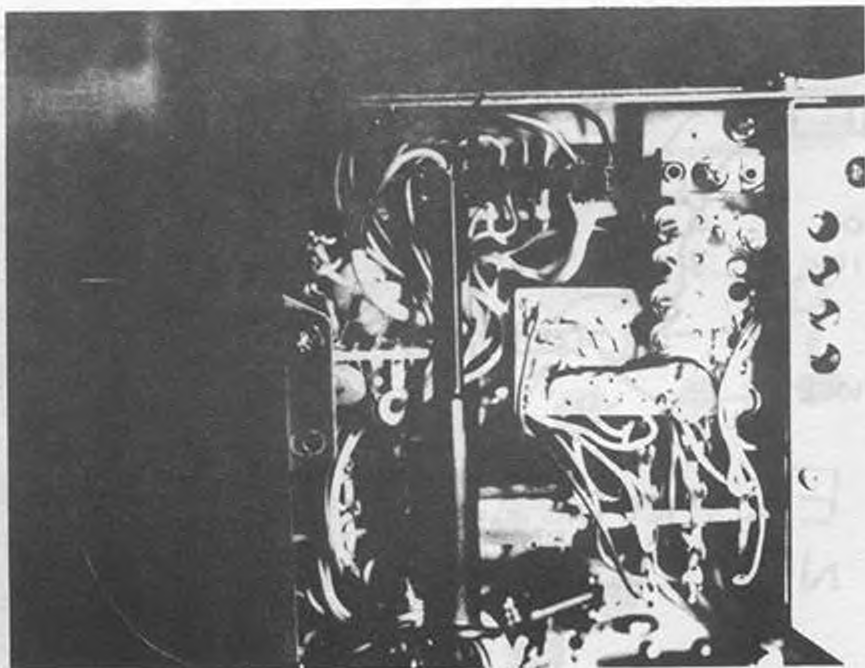

This photo shows the PLL Box that must be removed before the counter box may be removed.

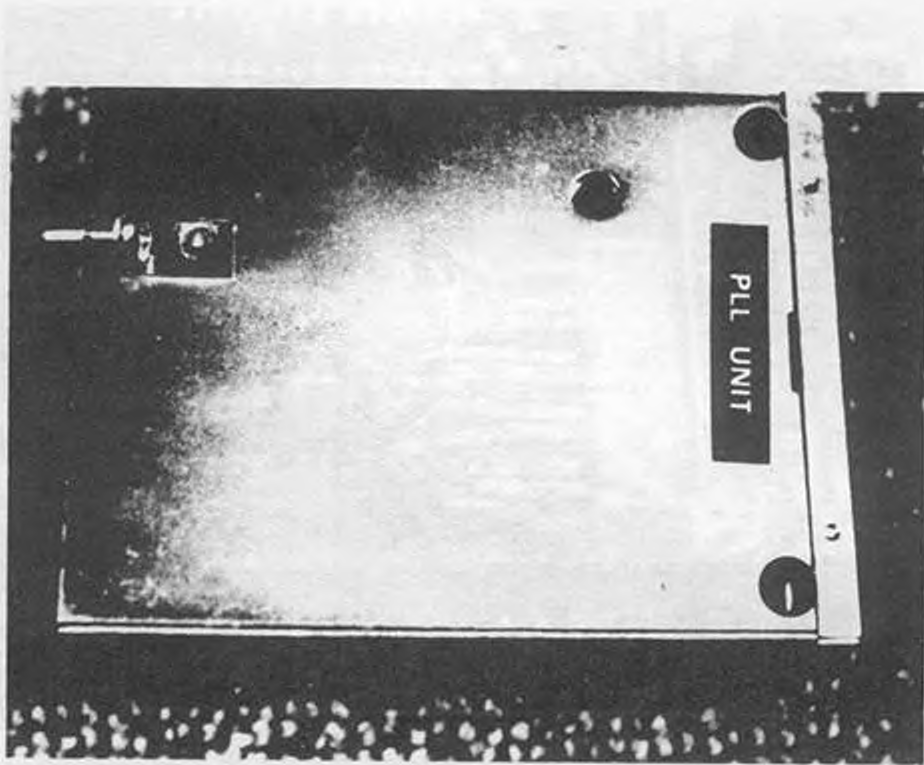

This photo shows the view of chassis where the PLL Unit and the counter unit were removed.

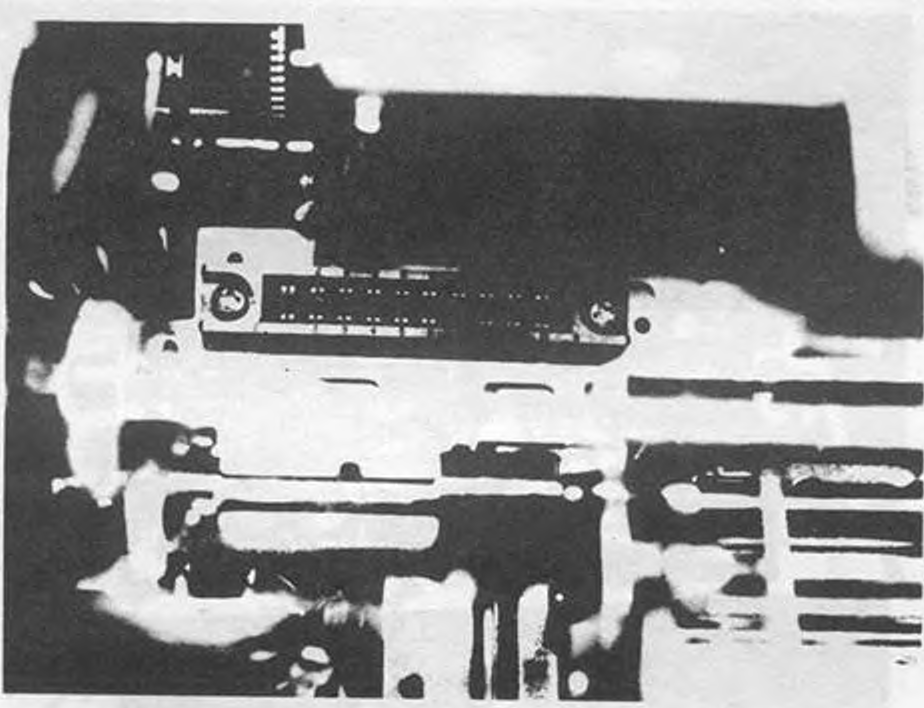

This photo shows the inside view of the frequency counter unit before modification.

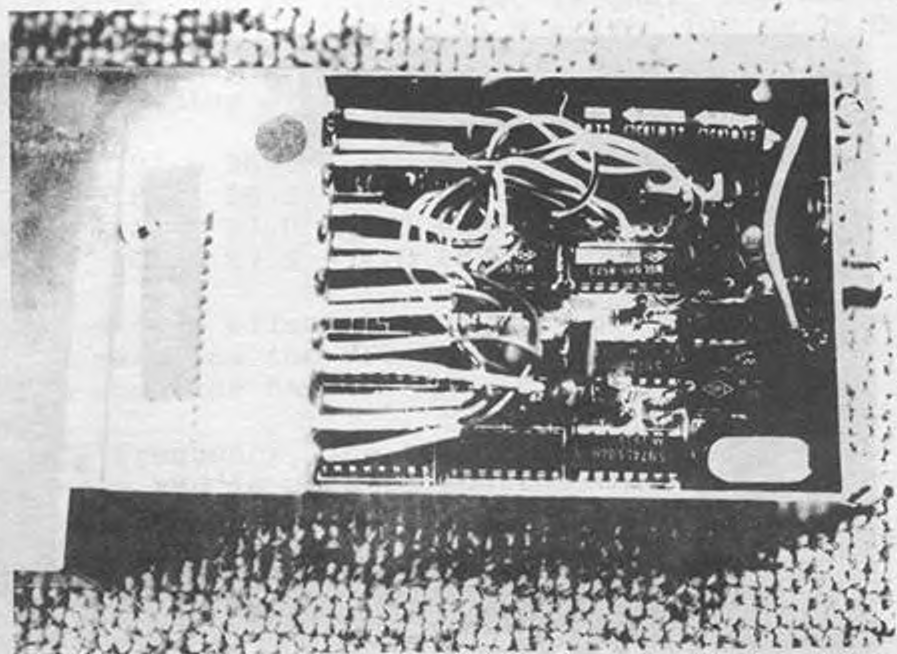

Inside view of counter unit with the diodes installed.

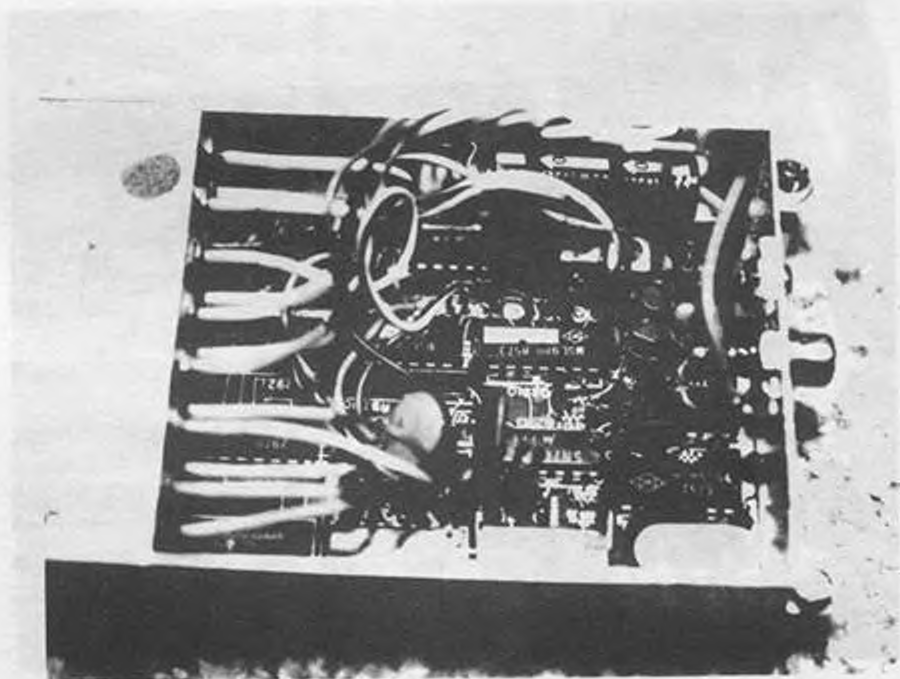

View of bottom of counter p/c board after modification. Diode wires must be trimmed close.

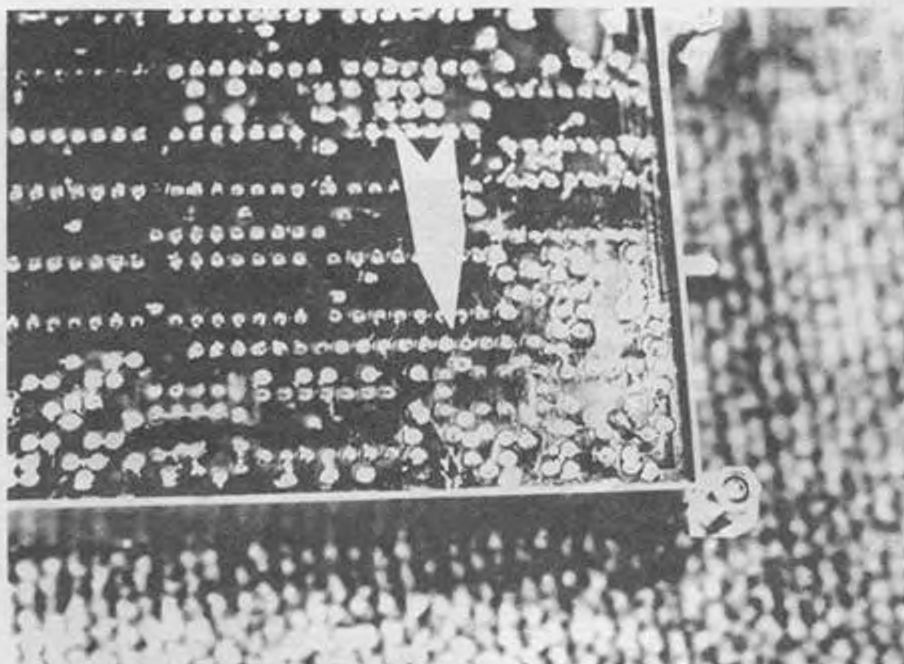

View of frequency counter board installed in radio. Modification completed, note short leads on diodes.

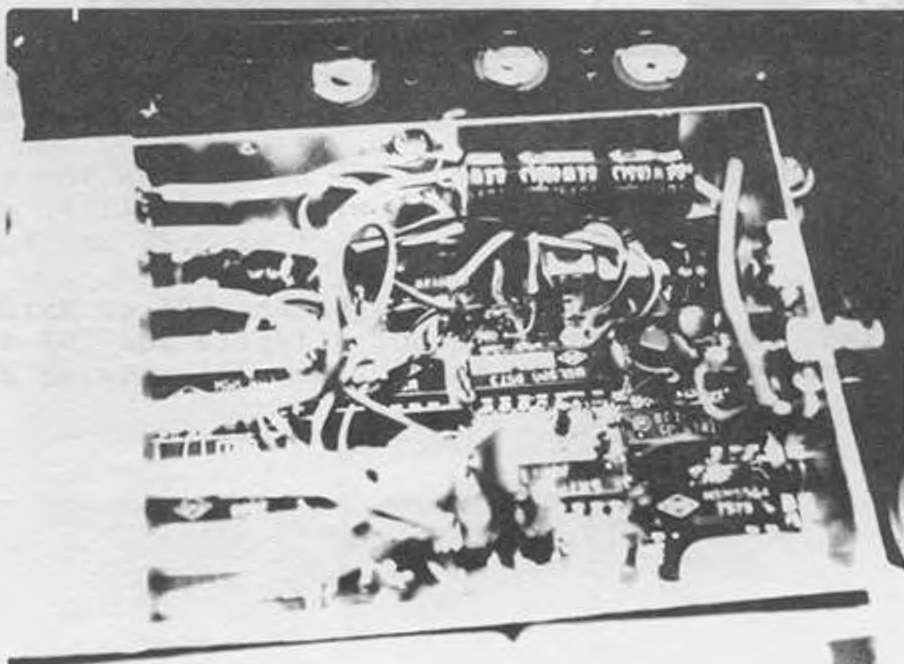

- (a) Put band switch to 10B and tune coil next to 40.9875 crystal to maximum.
- (b) Put band switch to 10C and tune coil next to 41.4875 crystal to maximum.
- (c) Switch to 10D and peak coil next to 41.9875 crystal to maximum.
- (d) At least .3 volts RMS should be noticed on pin 13 on all four bands.
- (e) Flip channel selector from 10A thru 10D and make sure all crystals are still oscillating.

This photo shows the crystal box and the position of the coils to be tuned.

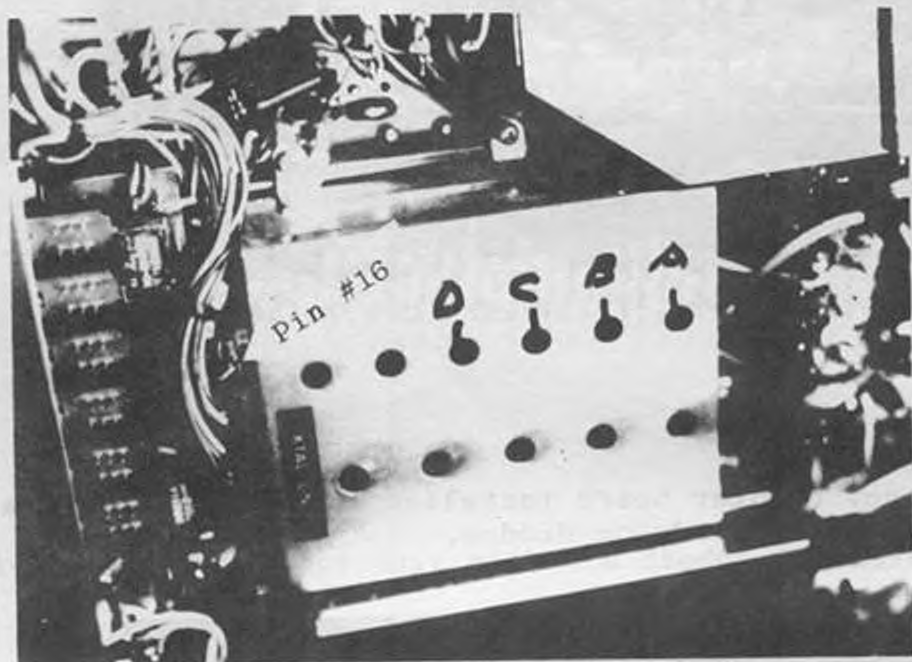

Do not remove cover of VCO unit to adjust. Make the adjustments with a small non-metallic tool.

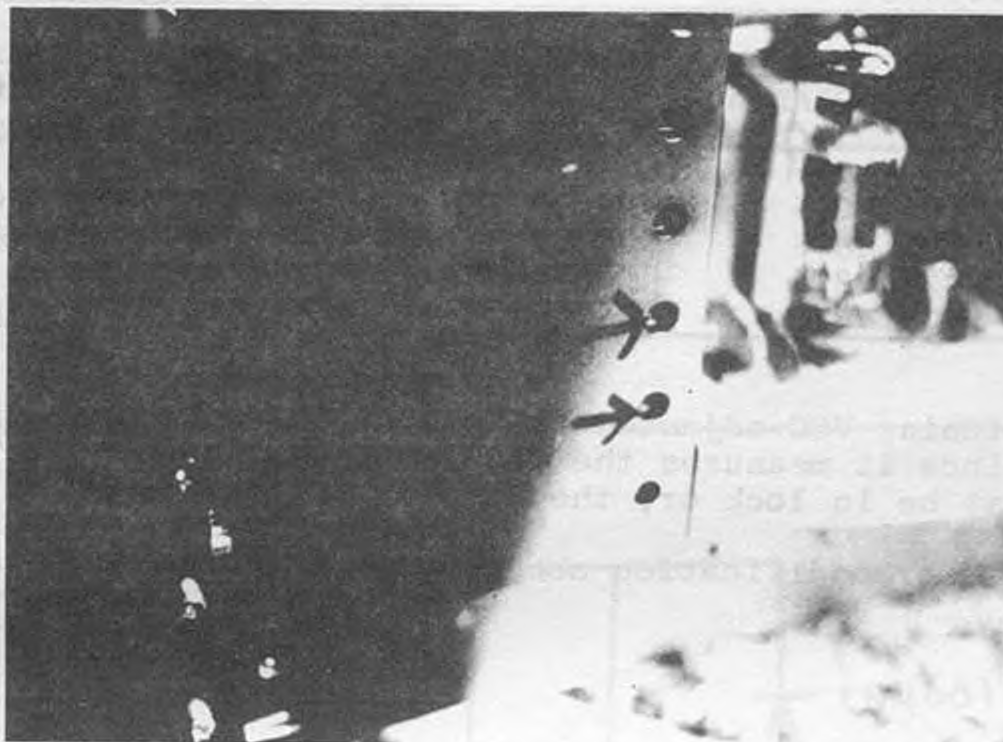

With an insulated tool, adjust 10A and 10B to read 34.9875 MHZ on counter, switch to 100 and if counter does not display 35.4875, slightly readjust 10A and 10B. When switch is rotated from 10A to 10B, an instant lock on 10A of 34.9875 and on 10B of 35.4875 should be measured on the counter.

If VFO is not exactly on 000, the counter will show a little high or a little low. This is not important, but the basic lock up at 35.4 and 35.9 is.

Next, switch to 10C and adjust 10C and 10D to 35.9875. Then switch to 10D and slightly touch up for 36.4875. Switch back and forth between 10C and 10D and watch counter for lock up.

SUMMARY

| BAND | CRYSTAL USED | COLOR OF DISPLAY CONTROL WIRE | FREQ. RANGE |
|------|--------------|-------------------------------|------------------|
| 10A | 40.4875 | BLUE | 26.000 to 26.500 |
| 10B | 40.9875 | VIOLET | 26.500 to 27.000 |
| 10C | 41.4875 | GREY | 27.000 to 27.500 |
| 10D | 41.9875 | WHITE | 27.500 to 28.000 |

| BAND | VFO DIAL at 000 | | VFO DIAL at 500 | |
|------|-------------------|---------|-------------------|---------|
| | VCO FREQ. (pin 2) | DISPLAY | VCO FREQ. (pin 2) | DISPLAY |
| 10A | 34.9875 | 26.000 | 35.4875 | 26.500 |
| 10B | 35.4875 | 26.500 | 35.9875 | 27.000 |
| 10C | 35.9875 | 27.000 | 36.4875 | 27.500 |
| 10D | 36.4875 | 27.500 | 36.9875 | 28.000 |

Note: While tuning VCO adjustments, the display will remain the same since it measures the VFO instead of the VCO. The VCO must be in lock or, the display will be in error.

View of unit after modification completed. Note counter display of 26.500 MHZ.



Reinstall all covers the Modification is now complete.

SECRET CB TEST TONE

PARTS:

One 555 IC timer
Two 1K ohm $\frac{1}{2}$ watt 10%
One 500K ohm POT or trim tabs
One 20 ohm POT
Two 1N4001
One .02 pf 16 volts
One 10 f 16 volts
One 9 volt battery
One Battery Connector
One SPST normally off push button switch
One small box

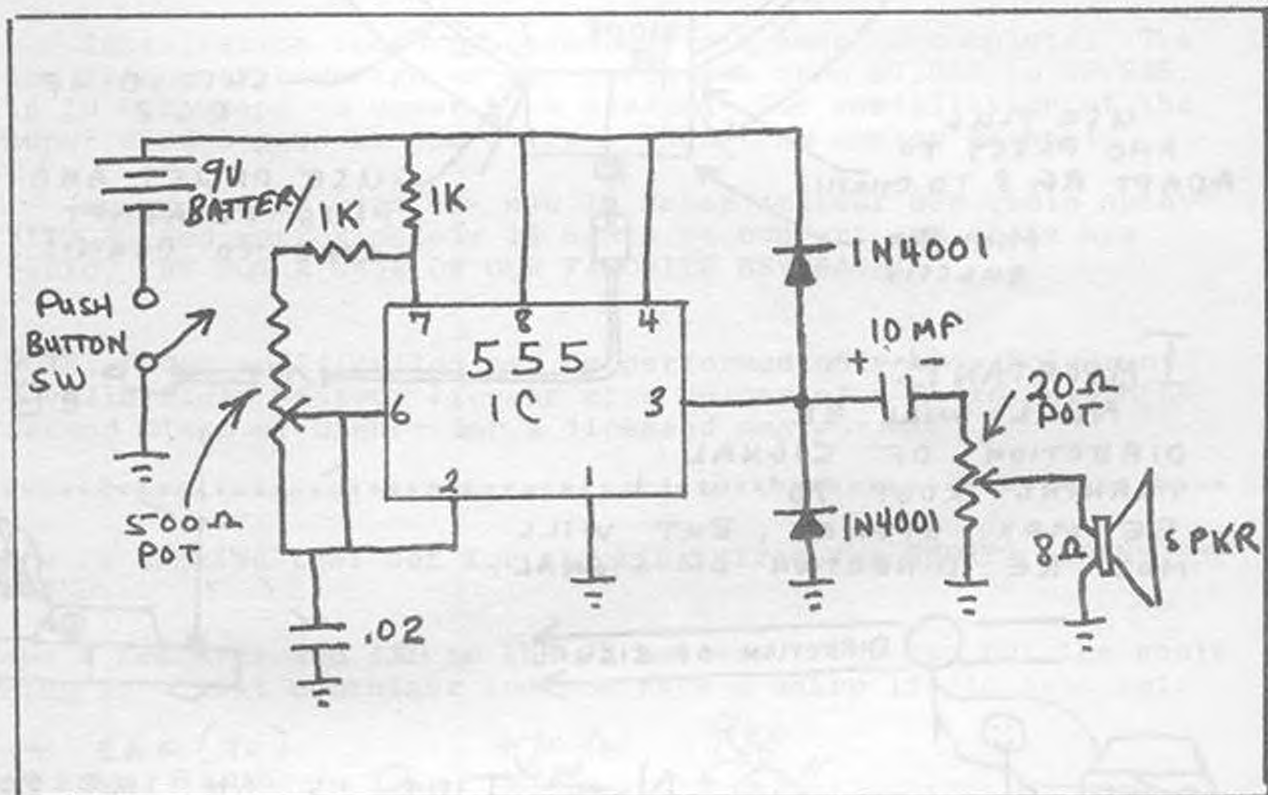

Install all parts on vector board and mount in small box. You may use trim tabs or external controls. If you build two of these units you will have a two tone generator. Mount in the same box. This unit is good for 100HZ to 20 HZ.

"SECRET CB" ERRONEOUS SIGNAL LOCATOR

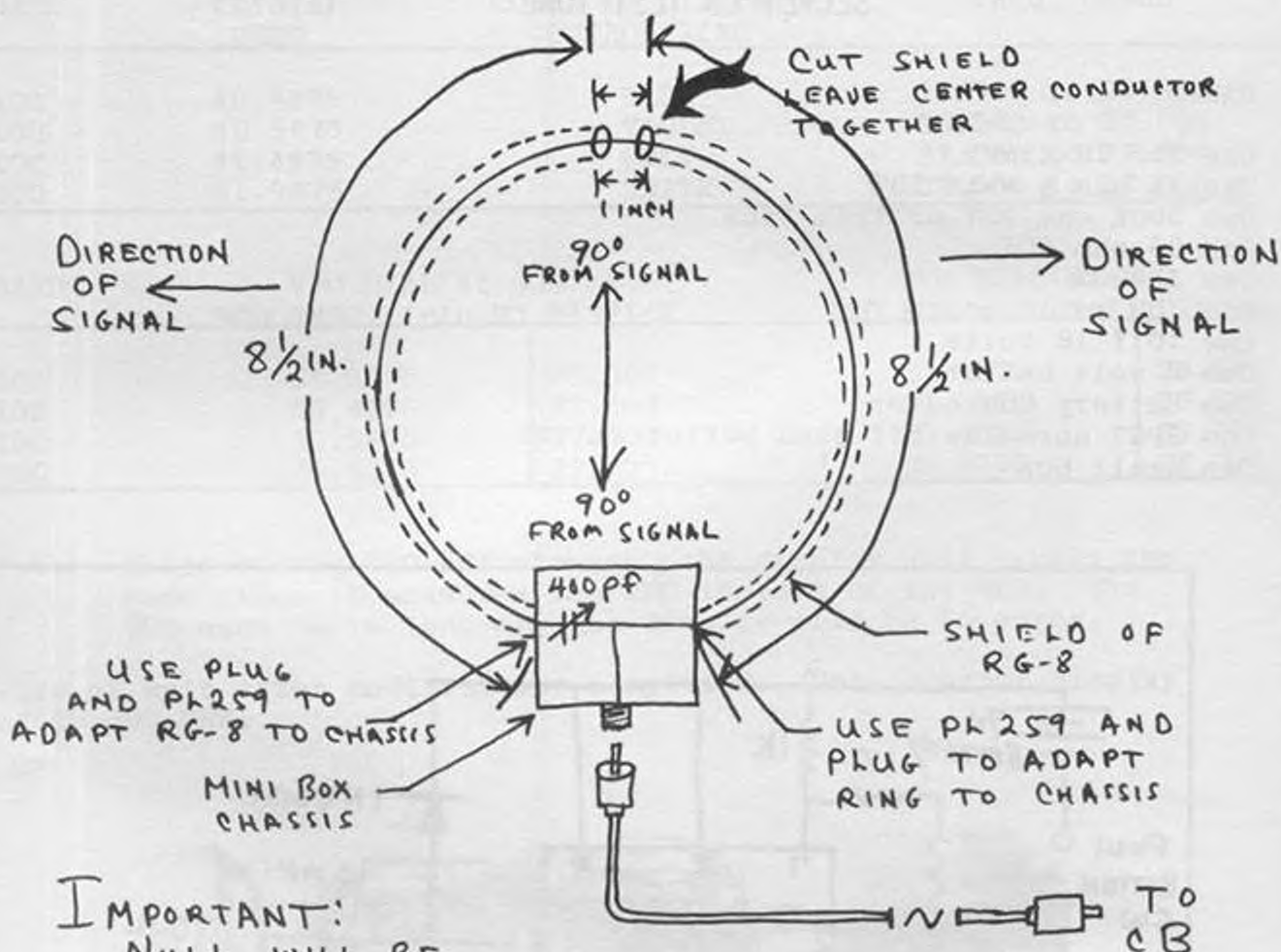

IMPORTANT:
 NULL WILL BE
 DIRECTION OF SIGNAL.
 TURNING LOOP 90° WILL
 BE MAX. SIGNAL, BUT WILL
 NOT BE DIRECTION OF SIGNAL.



(NULL POSITION)
 A.

0 1 2 3 4 5 6 7 8 9

TYPICAL METER READING
 ON CB



NOTE: THIS IS AN INEXPENSIVE
 WAY TO LOCATE A SIGNAL
 FROM ANOTHER TRANSCIEVER.
 MOVING TO POSITION B WILL
 FORM A TRIANGLE
 TO LOCATE SIGNAL.

NULL POSITION

B.

Recently, an amateur friend of our's commented on the high price of 10 meter gear. And, I told him he did not have to use the high price commercial equipment. I told him I could get him on the air with a \$150.00 or less. He told us this was not possible to do. So, a friendly wager was made for a case of our favorite beverage.

The first step we took was to go out to the local Flea-market. We found a Cobra 138 XLR. After much haggling over the price, it was purchased for \$50.00. The unit had a bad final, which cost \$9.35 to replace. Three crystals (11.8858, 11.8850, & 11.8842), three super diodes, and a switch kit were purchased for another \$60.00. This brought the price of the radio and modification up to \$119.35. The kit came with all instructions for installation, which we bought from our favorite part's and accessories dealer.

Installation took approximately one hour to complete. The new frequency coverage on the radio was from 27.855 to 29.845, in 10 KHz steps to cover 10 M + MARS. The installation of the super diodes gave us the slide \pm 8KHz from center channel.

So my friend with his new 10 Meter Amateur SSB radio spent \$119.35 and approximately 1½ hours to convert and aline his radio. WE GOT A CASE OF OUR FAVORITE BEVERAGE!!

NOTE: This modification may be performed only by a holder of a valid Radio Amateur License or a holder of a Radio Telephone Second Class or higher for a licensed amateur.

Here is a quick test set for checking wires for SHORTS, OPENS, or GROUNDS.

Tape a resistor and LED to the 9V battery. You can put the whole thing in a pill container and you have a sharp little test set.

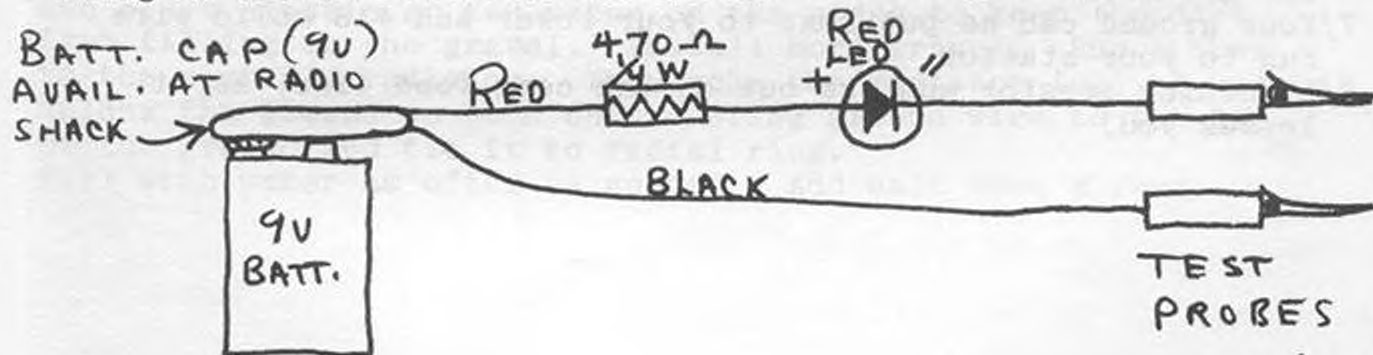

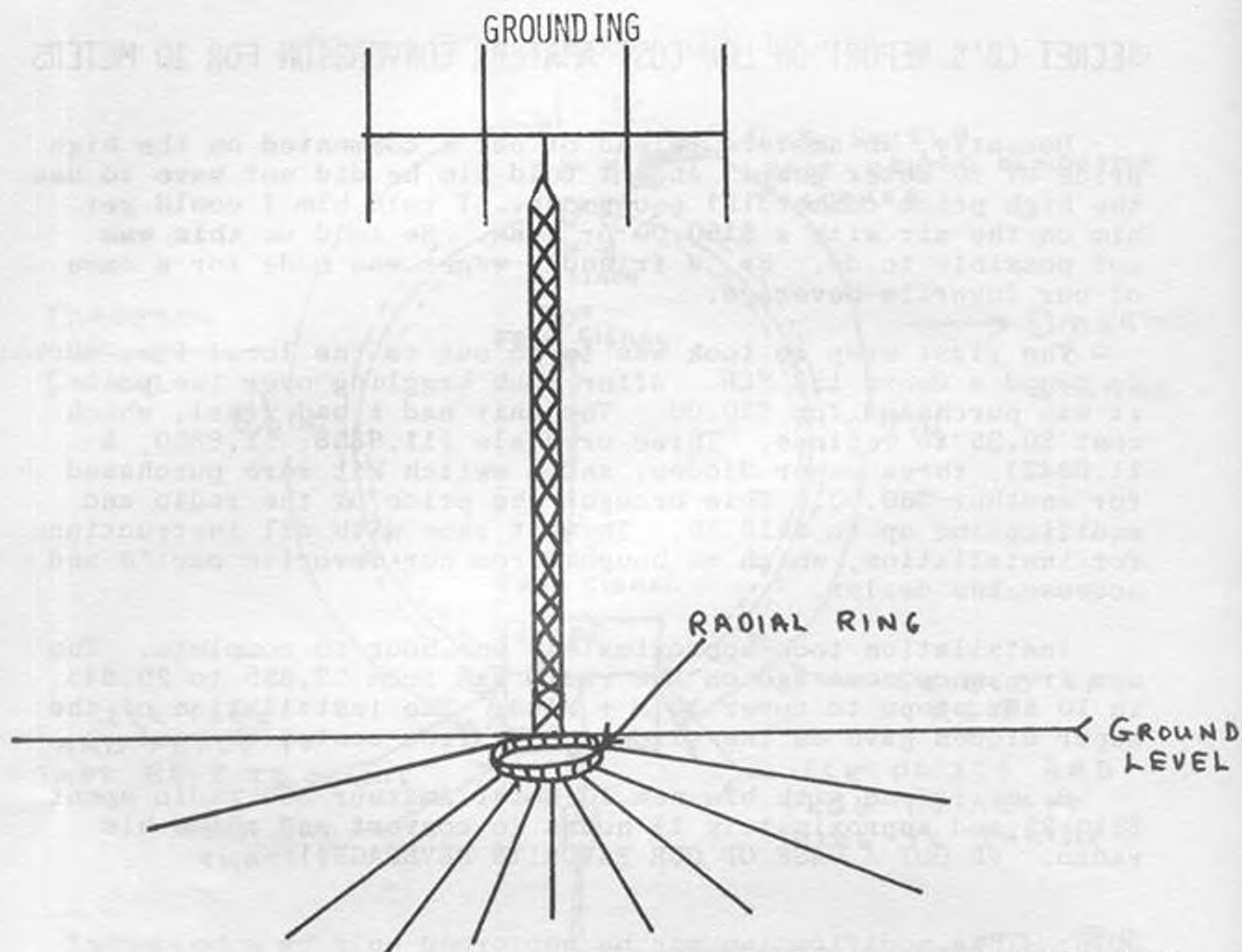

- 1/Radials must be at least 16 feet long and no longer than 36 feet.
- 2/Radials must be just below the surface of the ground or on top.
Use a lawn edger to cut groves.
- 3/The wire I use is electric fence wire from Sears. This is the most economical.
- 4/You need 120 radials at the least. (The more the better up to 360).
- 5/All radials are brought up out of the ground around the antenna and soldered to the ground ring.
- 6/The radial ring is $\frac{1}{2}$ inch copper tubing. (Approximately 6 in. of the ground).
- 7/Your ground can be put next to your tower and #13 solid wire run to your station.
- 8/Lightning arestor must be put on the coax feed line, as it leaves you.

GROUND YOUR RIG

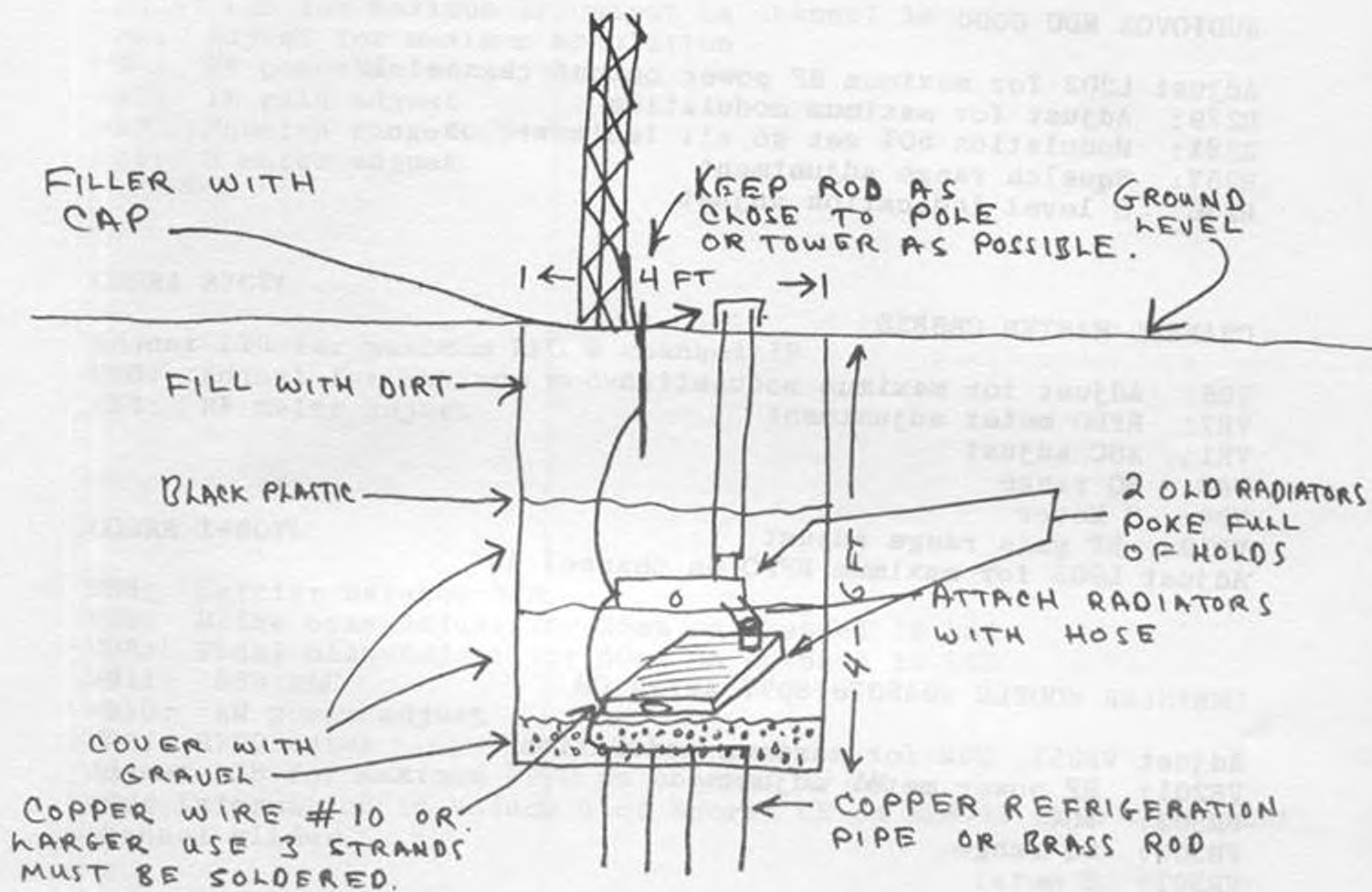

A good ground is the most important thing you can do for your station. First for safety and second for good performance. First dig your hole and set your bottom rods. Solder them together with #10 wire, use three strands. Cover the bottom of the hole with gravel and sprinkle with rock salt and crushed charcoal. Install an old radiator in the hole. You may use black plastic or tar paper on the sides to keep the dirt from filling in the gravel. Install more gravel. Run a hose to the next old radiator. Then poke the radiator full of holes. Solder the ground to each unit. Bring ground wire to the top of the ground and tie it to radial ring. Fill with water as often as needed. Add salt once a year.

SPECIFIC RADIO TUNE-UPS

AUDIOVOX MDU 6000

Adjust L202 for maximum RF power output channel 19
R279: Adjust for maximum modulation
R281: Modulation 50% set so all led's are on
R257: Squelch range adjustment
R236: S level indication adjust

CHANNEL MASTER CB6835

VR6: Adjust for maximum modulation
VR7: RFPO meter adjustment
VR1: AGC adjust
VR3: SQ range
VR4: S Meter
VR10: RF gain range adjust
Adjust L905 for maximum RFPO on channel 19

CHRYSLER MODELS 4048076/8077 AM/FM CB

Adjust VR251, 252 for maximum modulation
VR201: RF power meter adjust
VR302: AGC
VR303: SQ range
VR301: S meter
VR305: Audio gain

CLARION TC-203E

Adjust: L203 for maximum RF power output on channel 19
Adjust: VR201 for maximum modulation on chip D205

COBRA 89GTL, 1000GTL

VR6: Adjust power maximum modulation
VR5: Modulation meter adjust
VR4: RF power meter adjust
VR1: IF gain adjust
VR3: Squelch range adjust
VR2: S meter
Adjust L13 for maximum RF output on channel 19

COBRA 78X

Adjust L15 for maximum RF output on channel 19
VR6: Adjust for maximum modulation
VR5: RF power meter adjust
VR7: IF gain adjust
VR3: Squelch range adjust
VR4: S meter adjust

COBRA 87GTL

Adjust L13 for maximum RFO @ channel 19
VR6: Adjust for maximum modulation
VR4: RF meter adjust

COBRA 148GTL

VR4: Carrier balance SSB
VR9: Drive bias-Adjust for 25ma on channel 19 USB
VR8: Final bias-Adjust for 50ma on channel 19 USB
VR11: SSB ALC
VR10: AM power adjust
VR6: RFPO meter
Adjust L38 for maximum RFPO on channel 19 AM
*See information in Volume 5 of Secret CB on MB8719 chip to expand channel slider.

COLT 485

RV8: SSB AGC
RV9: AM SQ range
RV10: SSB SQ range
RV6: AM S meter
RV7: SSB S meter
RV3: Power meter
*See Volume 3 of Secret CB for expanding channels on PLL 02A chip.
Adjust T12 for maximum on USB 19
RV2: SSB power
RV4, RV5: Balance
VR4: AM power
RV12: Adjust for 100% modulation
Adjust T4, T5, T11, T6, L7, L11, L13, for maximum power channel 19 USB

IF YOUR CLARIFIER IS TOO SENSITIVE
INSTALL A 10-TURN CONTROL YOURSELF

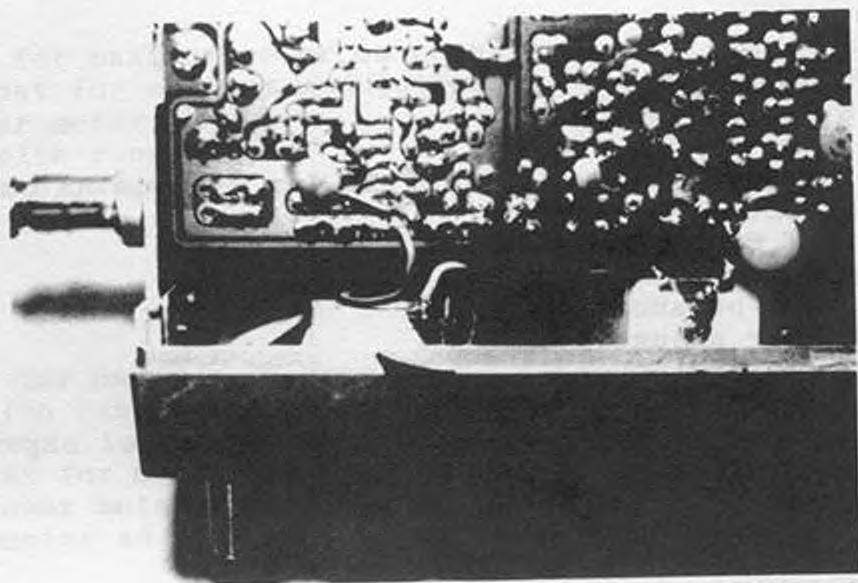

SUPER CLARIFIER
10 TURN POT
(REPLACES STOCK CONTROL)



STYLE
X-1

INSTRUCTIONS

- ① OBTAIN STYLE X-1 POT FROM YOUR FAVORITE PARTS PLACE.
- ② WIRE IN AS YOU WOULD WITH THE OLD CONTROL.
- ③ STYLE MAY VARY WITH MANUFACTURE. REALLY MAKES A SMOOTH CLARIFIER. ADD OR MODIFY OLD KNOB TO FIT.

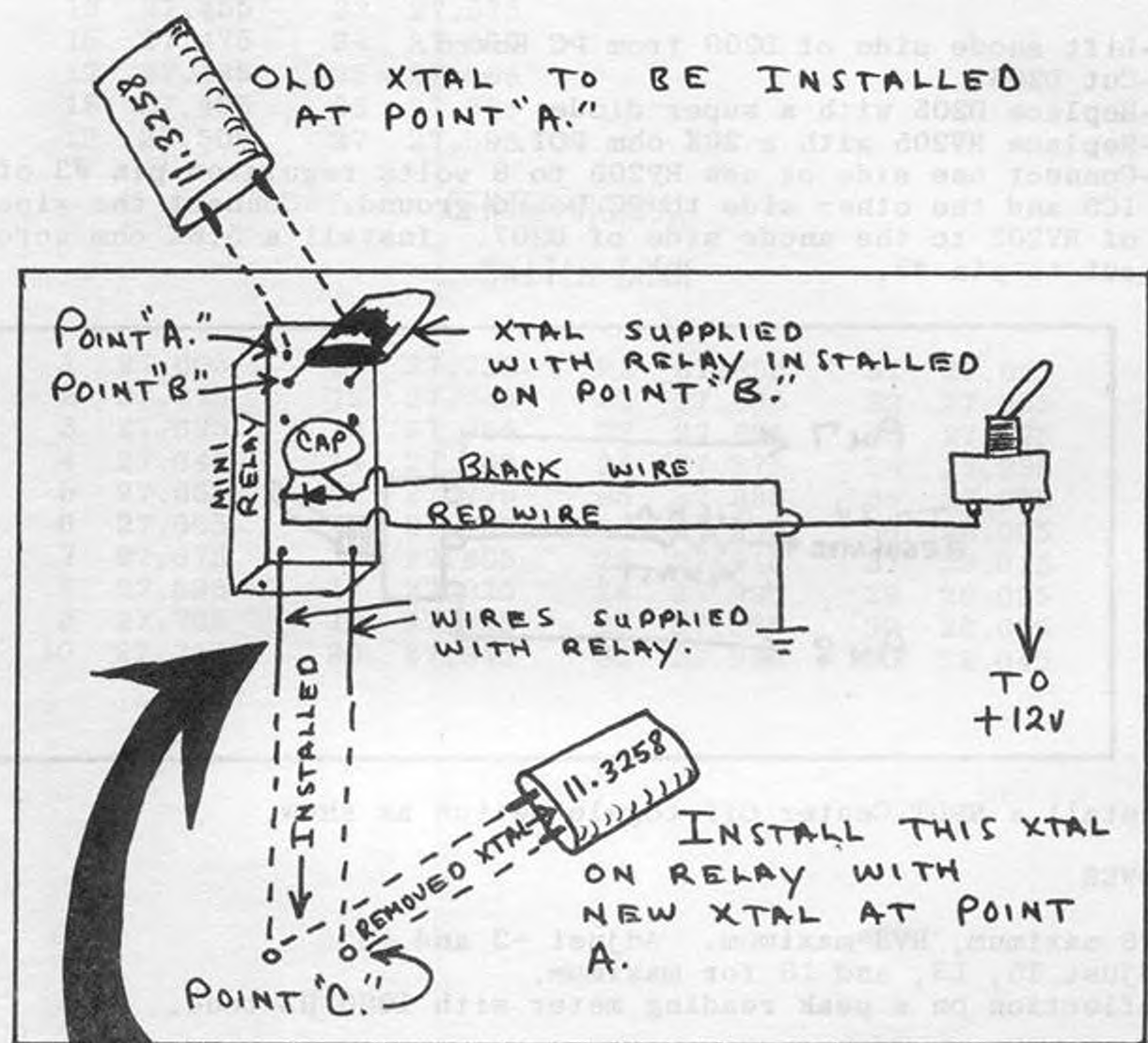

IMPORTANT

DO NOT MOUNT RELAY ASSEMBLY OVER 1 INCH FROM ORIGINAL XTAL LOCATION. KEEP LEADS SHORT!

INSTRUCTIONS:

- ① REMOVE XTAL 11.3258 FROM PC BOARD AND INSTALL ON BLANK CONTACTS AT POINT "A."
- ② INSTALL RELAY ASSEMBLY AS SHOWN AT POINT C.

RANGER T 4012 WITH MB8709 CHIP

CHANNEL EXPANSION AND MODIFICATION:

- 1-Lift anode side of D209 from PC Board.
- 2-Cut D206.
- 3-Replace D205 with a super diode.
- 4-Replace RV205 with a 20K ohm POT.
- 5-Connect one side of new RV205 to 8 volts regulated pin #3 of IC5 and the other side to PC Board ground. Connect the wiper of RV205 to the anode side of D207. Install a 5.6K ohm across cut to pin #8.

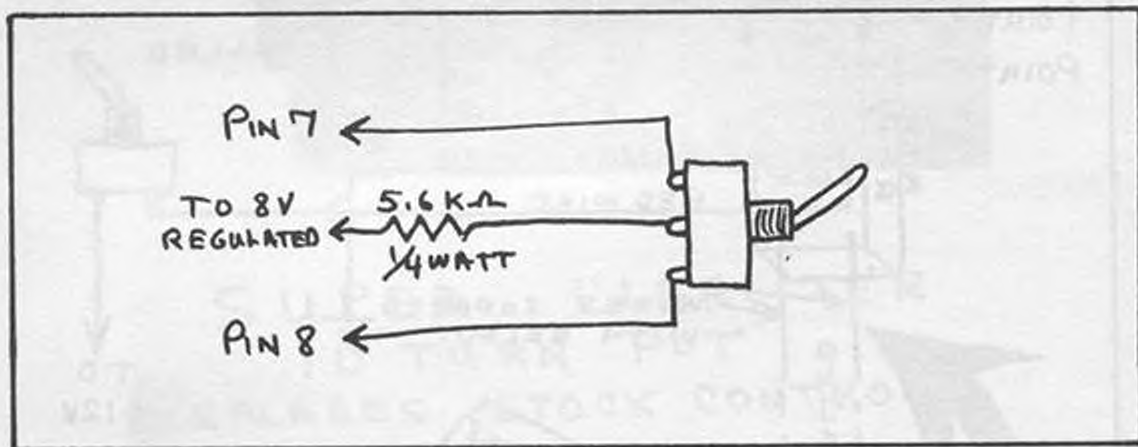

Install a SPDT Center Off toggle switch as show.

POWER

RV8 maximum, RV3 maximum. Adjust +2 and +3.
Adjust T5, L3, and L6 for maximum.
Deflection on a peak reading meter with 1000 HZ tone.

SWITCH UP

| | | | |
|----|--------|----|--------|
| 12 | 27.425 | 20 | 27.525 |
| 13 | 27.435 | 21 | 27.535 |
| 14 | 27.445 | 22 | 27.545 |
| 15 | 27.455 | 23 | 27.575 |
| 16 | 27.475 | 24 | 27.555 |
| 17 | 27.485 | 25 | 27.565 |
| 18 | 27.495 | 26 | 27.585 |
| 19 | 27.505 | 27 | 27.595 |

CENTER NORMAL

SWITCH DOWN

| | | | | | | | |
|----|--------|----|--------|----|--------|----|--------|
| 1 | 27.605 | 11 | 27.725 | 21 | 27.855 | 31 | 27.955 |
| 2 | 27.615 | 12 | 27.745 | 22 | 27.865 | 32 | 27.965 |
| 3 | 27.625 | 13 | 27.755 | 23 | 27.895 | 33 | 27.975 |
| 4 | 27.645 | 14 | 27.765 | 24 | 27.875 | 34 | 27.985 |
| 5 | 27.655 | 15 | 27.775 | 25 | 27.885 | 35 | 27.995 |
| 6 | 27.665 | 16 | 27.795 | 26 | 27.905 | 36 | 28.005 |
| 7 | 27.675 | 17 | 27.805 | 27 | 27.915 | 37 | 28.015 |
| 8 | 27.695 | 18 | 27.815 | 28 | 27.925 | 38 | 28.025 |
| 9 | 27.705 | 19 | 27.825 | 29 | 27.935 | 39 | 28.035 |
| 10 | 27.715 | 20 | 27.845 | 30 | 27.945 | 40 | 28.045 |

*****OOPS! WE GOOFED!*****

CORRECTIONS FOR VOLUME 5

Page 28-#2 should be Q405 (not 0405)

Page 20-should be pin #10 and #11 (not 9 and 10)

Page 19-#4 should be S5 (not 55)

SWITCH WIRING DIAGRAM FOR SEARS ROADTALKER 40 (SSB)

MODEL #934-3826-0700

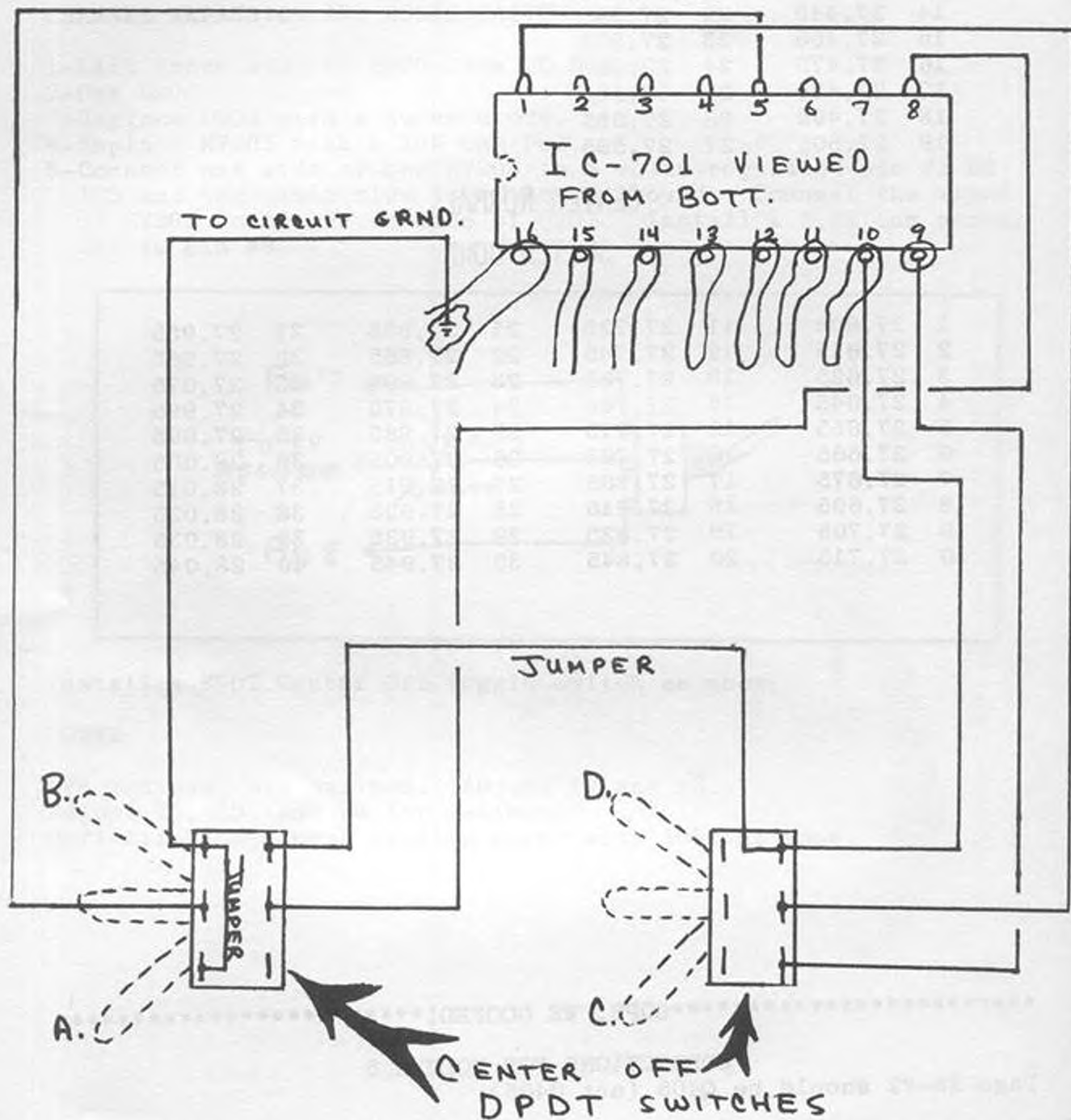

NOTE: PIN #5 and #9 are blank before modification. VCO adjustment is necessary.

SWITCH POSITION

| "A" | | "B" | | "A & D" | | "B & D" | | "C" | | "D" | |
|-----|--------|-----|--------|---------|--------|---------|--------|-----|--------|-----|--------|
| CH. | FREQ. | CH. | FREQ. | CH. | FREQ. | CH. | FREQ. | CH. | FREQ. | CH. | FREQ. |
| 1 | 26.325 | | | 1 | 26.645 | | | | | 1 | 27.605 |
| 2 | 26.330 | | | 2 | 26.650 | | | | | 2 | 27.615 |
| 3 | 26.335 | | | 3 | 26.655 | | | | | 3 | 27.625 |
| 4 | 26.345 | | | 4 | 26.665 | | | | | 4 | 27.645 |
| 5 | 26.350 | | | 5 | 26.670 | | | | | 5 | 27.655 |
| 6 | 26.355 | | | 6 | 26.675 | | | | | 6 | 27.665 |
| 7 | 26.360 | | | 7 | 26.680 | | | | | 7 | 27.675 |
| 8 | 26.370 | | | 8 | 26.690 | | | | | 8 | 27.695 |
| 9 | 26.375 | | | 9 | 26.695 | | | | | 9 | 27.705 |
| 10 | 26.380 | | | 10 | 26.700 | | | | | 10 | 27.715 |
| 11 | 26.385 | | | 11 | 26.705 | | | | | 11 | 27.725 |
| 12 | 26.395 | 12 | 26.555 | 12 | 26.715 | 12 | 26.875 | 12 | 27.425 | 12 | 27.745 |
| 13 | 26.400 | 13 | 26.560 | 13 | 26.720 | 13 | 26.880 | 13 | 27.435 | 13 | 27.755 |
| 14 | 26.405 | 14 | 26.565 | 14 | 26.725 | 14 | 26.885 | 14 | 27.445 | 14 | 27.765 |
| 15 | 26.410 | 15 | 26.570 | 15 | 26.730 | 15 | 26.890 | 15 | 27.455 | 15 | 27.775 |
| 16 | 26.420 | 16 | 26.580 | 16 | 26.740 | 16 | 26.900 | 16 | 27.475 | 16 | 27.795 |
| 17 | 26.425 | 17 | 26.585 | 17 | 26.745 | 17 | 26.905 | 17 | 27.485 | 17 | 27.805 |
| 18 | 26.430 | 18 | 26.590 | 18 | 26.750 | 18 | 26.910 | 18 | 27.495 | 18 | 27.815 |
| 19 | 26.435 | 19 | 26.595 | 19 | 26.755 | 19 | 26.915 | 19 | 27.505 | 19 | 27.825 |
| 20 | 26.445 | 20 | 26.605 | 20 | 26.765 | 20 | 26.925 | 20 | 27.525 | 20 | 27.845 |
| 21 | 26.450 | 21 | 26.610 | 21 | 26.770 | 21 | 26.930 | 21 | 27.535 | 21 | 27.855 |
| 22 | 26.455 | 22 | 26.615 | 22 | 26.775 | 22 | 26.935 | 22 | 27.545 | 22 | 27.865 |
| 23 | 26.470 | 23 | 26.630 | 23 | 26.790 | 23 | 26.950 | 23 | 27.575 | 23 | 27.895 |
| 24 | 26.460 | 24 | 26.620 | 24 | 26.780 | 24 | 26.940 | 24 | 27.555 | 24 | 27.875 |
| 25 | 26.465 | 25 | 26.625 | 25 | 26.785 | 25 | 26.945 | 25 | 27.565 | 25 | 27.885 |
| 26 | 26.475 | 26 | 26.635 | 26 | 26.795 | 26 | 26.955 | 26 | 27.585 | 26 | 27.905 |
| 27 | 26.480 | 27 | 26.640 | 27 | 26.800 | 27 | 26.960 | 27 | 27.595 | 27 | 27.915 |
| 28 | 26.485 | | | 28 | 26.805 | | | | | 28 | 27.925 |
| 29 | 26.490 | | | 29 | 26.810 | | | | | 29 | 27.935 |
| 30 | 26.495 | | | 30 | 26.815 | | | | | 30 | 27.945 |
| 31 | 26.500 | | | 31 | 26.820 | | | | | 31 | 27.955 |
| 32 | 26.505 | | | 32 | 26.825 | | | | | 32 | 27.965 |
| 33 | 26.510 | | | 33 | 26.830 | | | | | 33 | 27.975 |
| 34 | 26.515 | | | 34 | 26.835 | | | | | 34 | 27.985 |
| 35 | 26.520 | | | 35 | 26.840 | | | | | 35 | 27.995 |
| 36 | 26.525 | | | 36 | 26.845 | | | | | 36 | 28.005 |
| 37 | 26.530 | | | 37 | 26.850 | | | | | 37 | 28.015 |
| 38 | 26.535 | | | 38 | 26.855 | | | | | 38 | 28.025 |
| 39 | 26.540 | | | 39 | 26.860 | | | | | 39 | 28.035 |
| 40 | 26.545 | | | | | | | | | 40 | 28.045 |

10 METER BROWNING GOLDEN EAGLE MARK III MOD

PARTS LIST:

- (1) One switch kit with xtals
- (2) Adjustable slider coil

1-Turn the unit upside down and remove the bottom cover from transmitter. Locate CR6, CR5, and CR4. Remove them from the set one at a time; so you will not mix them up. Then install them on the switch. You must use a heat sink on the xtal leads so you will not damage the xtals. Install them as per drawing.

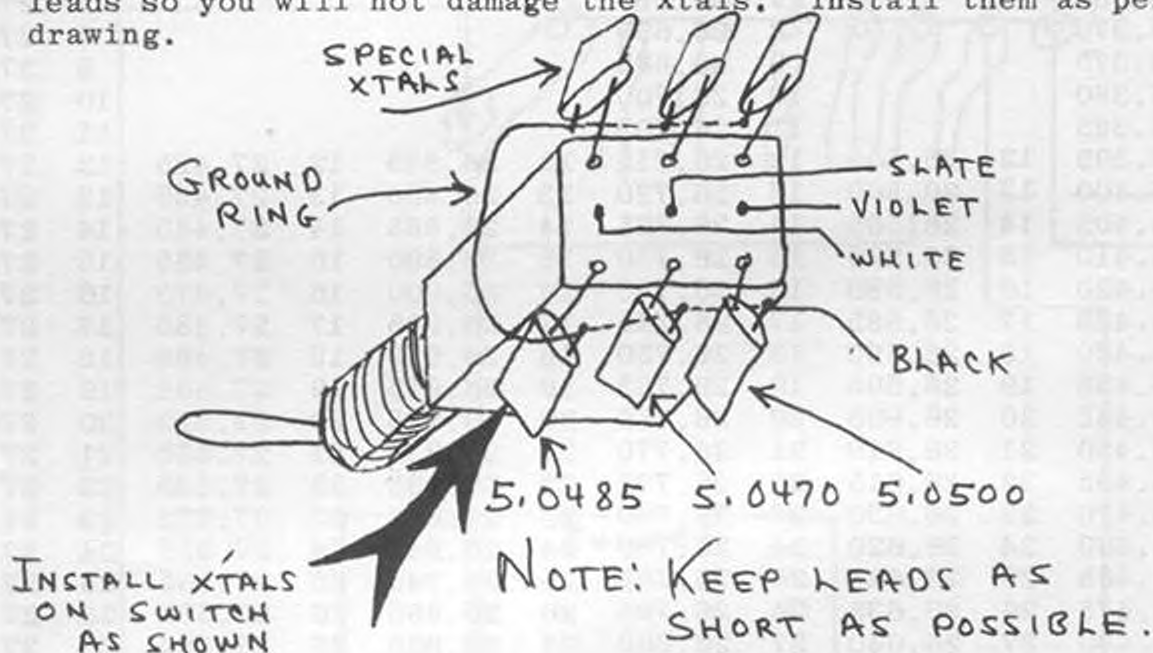

2-Mount your new switch in a convenient position thru the front panel.

FIGURE #2

3-Mount the new slider coil in the ground side of the VFO capacitor on the front panel. The coil may be adjusted for the best slide.

4-Peak up +6 for best results overall. This is the 5KHZ mixer.

FIGURE #3

5-You may change L5 and L7 for best slider results.

The new channel will be from channel 1, (27.265) to channel 23, (27.555). THIS COMPLETES THE MODIFICATION. REINSTALL IN CABINET.

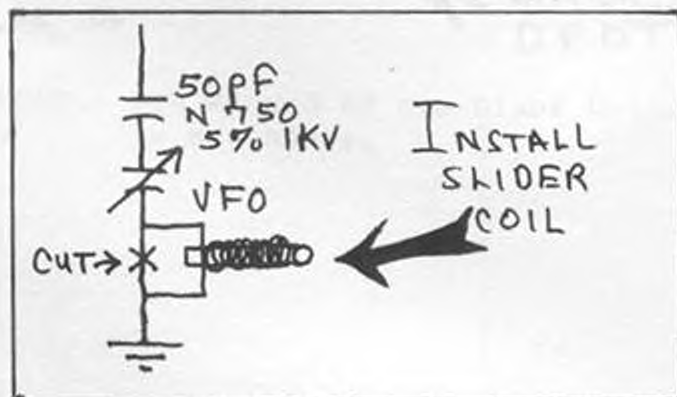

FIG. 2

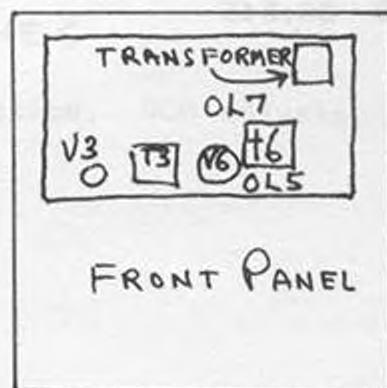
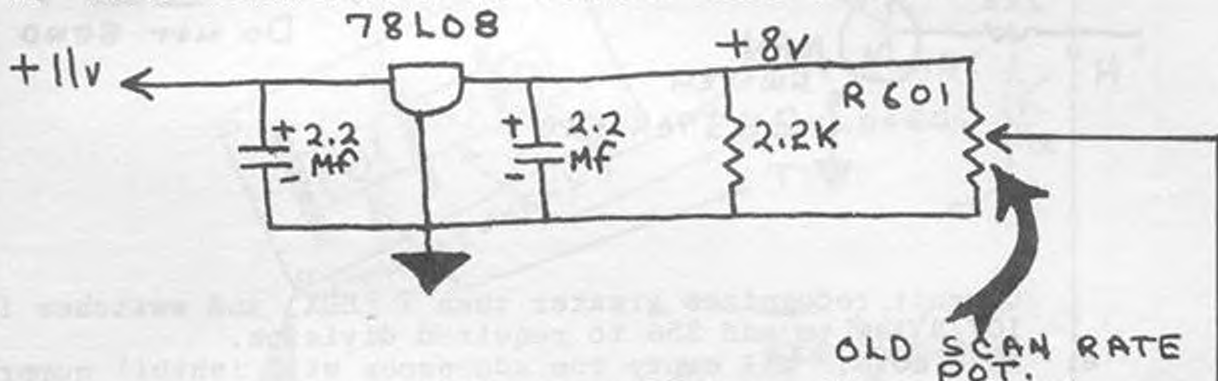

FIG 3

BROWNING EAGLE IV MODIFICATION

1. Remove up - down stops
 - a. IC 503/c disconnect one input jumper from select bank.
 - b. IC 503/d disconnect one input jumper from select bank.
2. Change scan rate function pot to slide transmitter
 - a. Remove wires from R601 and move to terminal strip installed near R601.
 - b. Substitute 47K fixed resistor for R601.
 - c. Build circuit shown on terminal strip added in B1.



- d. Install varactor diode in oscillator with associated components.

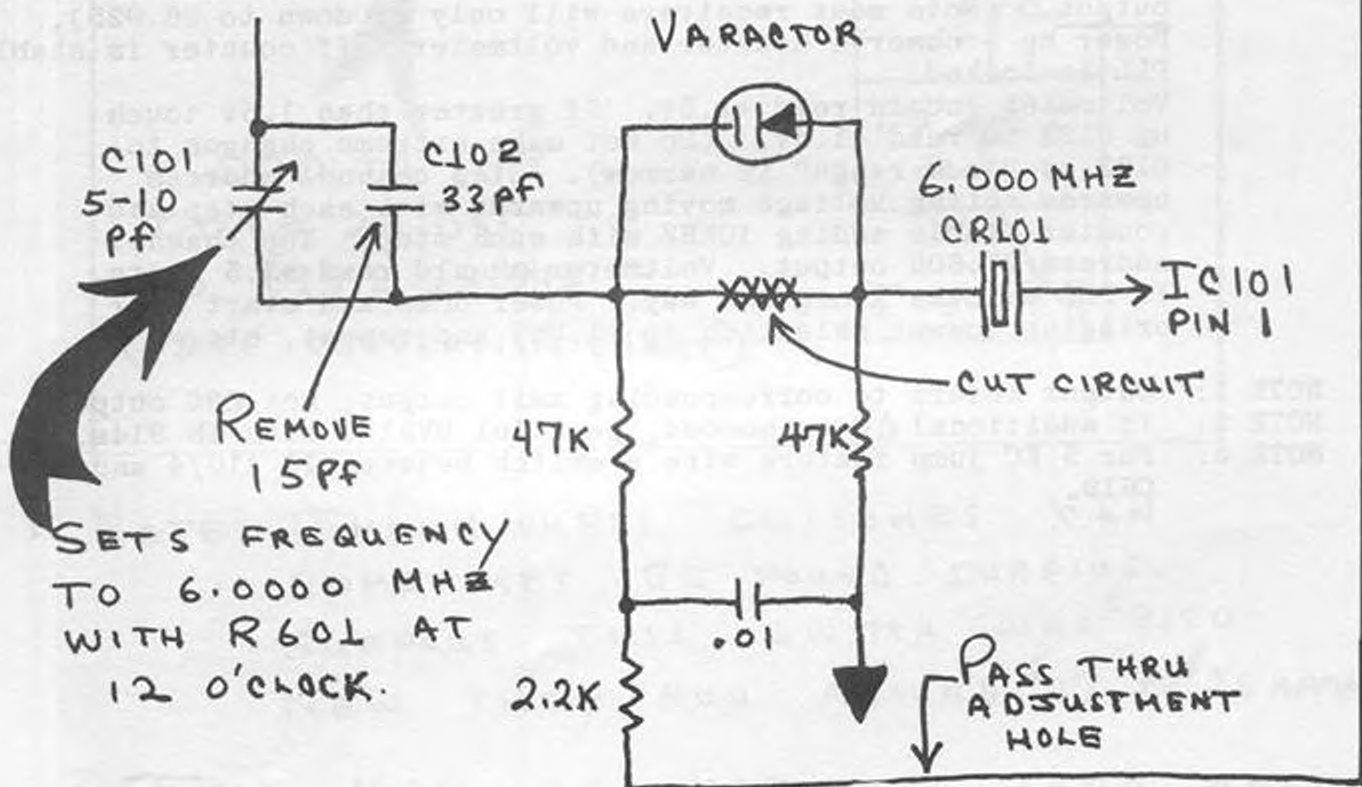

3. PLL Extension

- Disconnect point "H" (IC 106/6) from ground and add diode and resistor; duplicate A to G nodes.
- Add wires from "H" (via feed through cap) to IC 410/11.
- Install full feature ROM in place of original IC 410.
- Install circuit shown

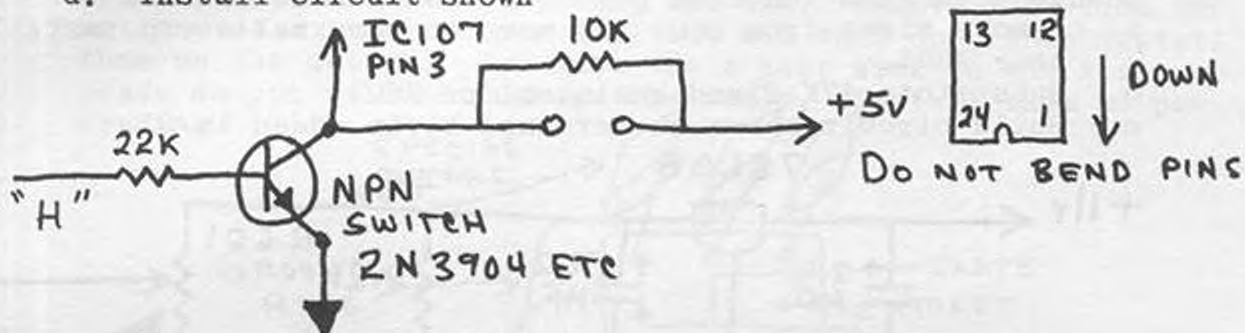

Circuit recognizes greater than 7 (HEX) and switches IC 107/3 low to add 256 to required division.

- As a note: all empty rom addresses will inhibit numerical display and transmitter key relay.
- Adjust C122 while monitoring T.P. (1.5 - 3.5V) with Voltmeter; and output BNC to frequency counter. Select lowest frequency required. Lowest frequency in full feature ROM is 26.885 output. (Note most receivers will only go down to 26.925).
Power up - observe counter and voltmeter. If counter is stable PLL is locked.

Voltmeter should read +1.5v. If greater than 1.5v touch up C122 to read +1.5v. (Do not make extreme changes to C122 as "lock range" is narrow). Step channel address upwards noting voltage moving upwards with each step and counter stable adding 10KHZ with each step. Top channel address 27.605 output. Voltmeter should read +3.5 volts. If PLL unlocks along the way. Power down and start over bringing lowest selection to +1.35V and repeat, etc.

- NOTE 1: Output refers to corresponding xmit output, not OSC output
NOTE 2: If additional ΔC is needed, parallel MV2111 with IN 914s.
NOTE 3: For 5 KC jump feature wire a switch between IC 410/4 and C619.

THUMBWHEEL 200 CHANNEL CONVERSION
AS APPLIED TO 858 CHASSIS

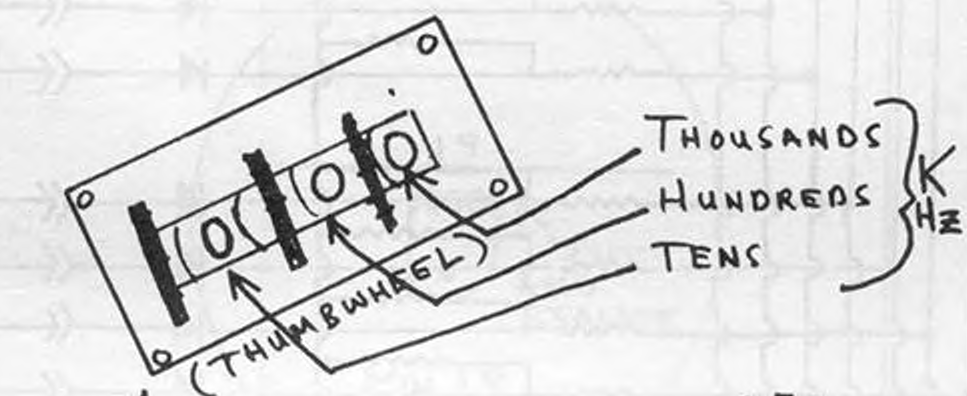

000 TO 199
001 = 26.065
TO 199 = 28.045
(SEE CONVERSION CHART)

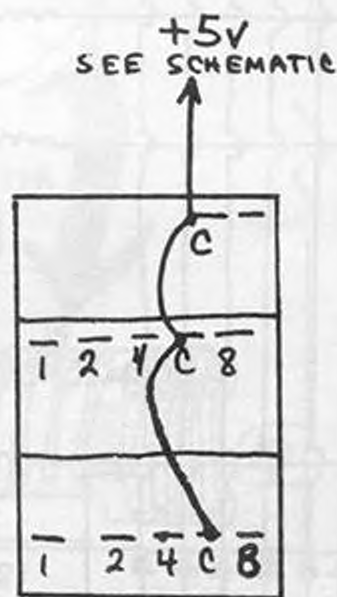

NOTE: THUMB WHEEL SWITCHES CAN SOMETIMES BE FOUND SURPLUS. SURPLUS THIS SWITCH WAS \$8.50. NEW THEY RUN AROUND \$17 TO \$20 APPROX.

THIS MOD. IS NOT AS HARD AS IT LOOKS!

200 CHANNEL CONVERSION
TO UNIDEN 858 PLL
26.085 TO 28.045

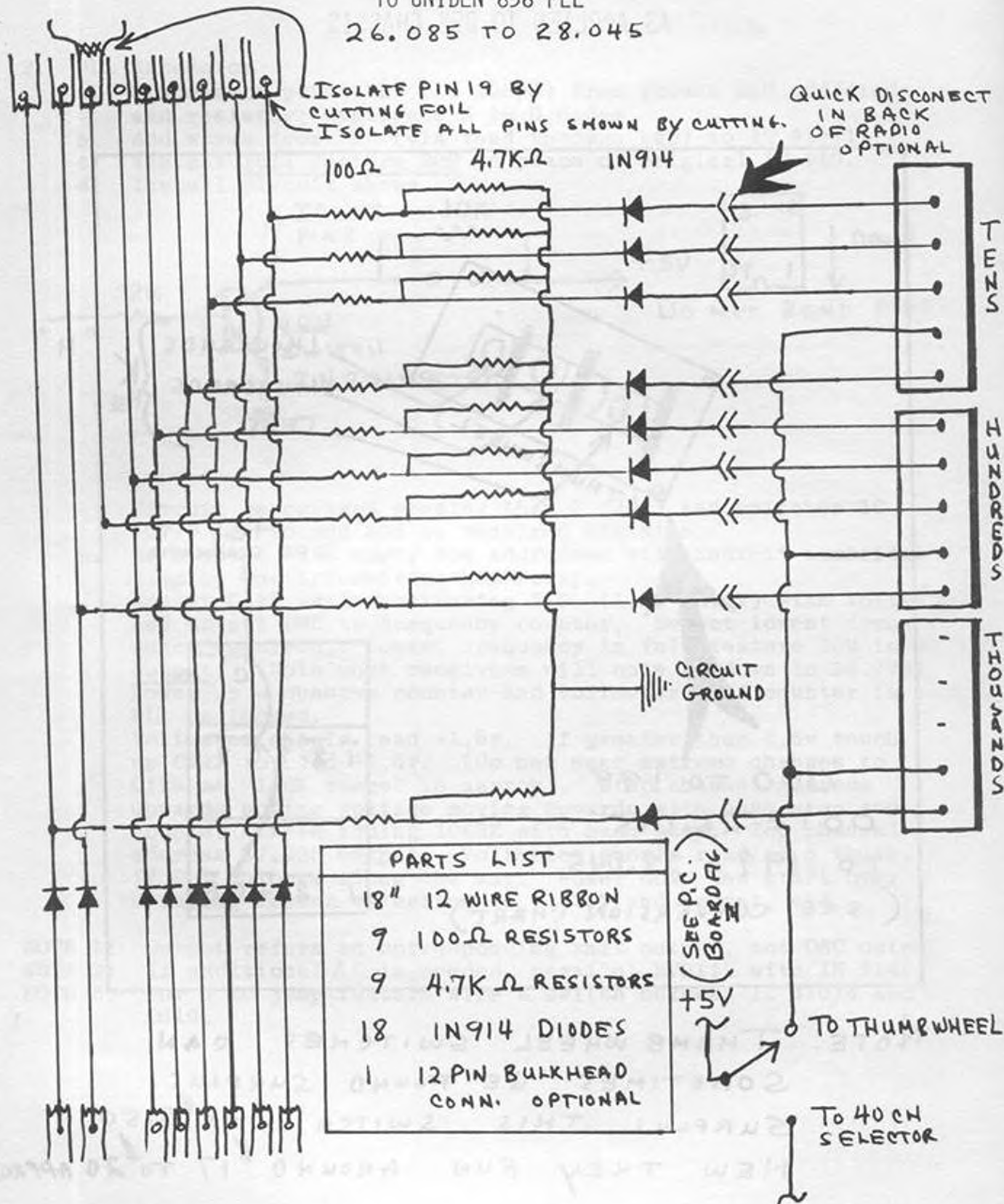

| PARTS LIST | |
|------------|--------------------------------|
| 18" | 12 WIRE RIBBON |
| 9 | 100Ω RESISTORS |
| 9 | 4.7K Ω RESISTORS |
| 18 | IN914 DIODES |
| 1 | 12 PIN BULKHEAD CONN. OPTIONAL |

200 CHANNEL CONVERSION
TO UNIDEN 858 PLL
26.085 TO 28.045

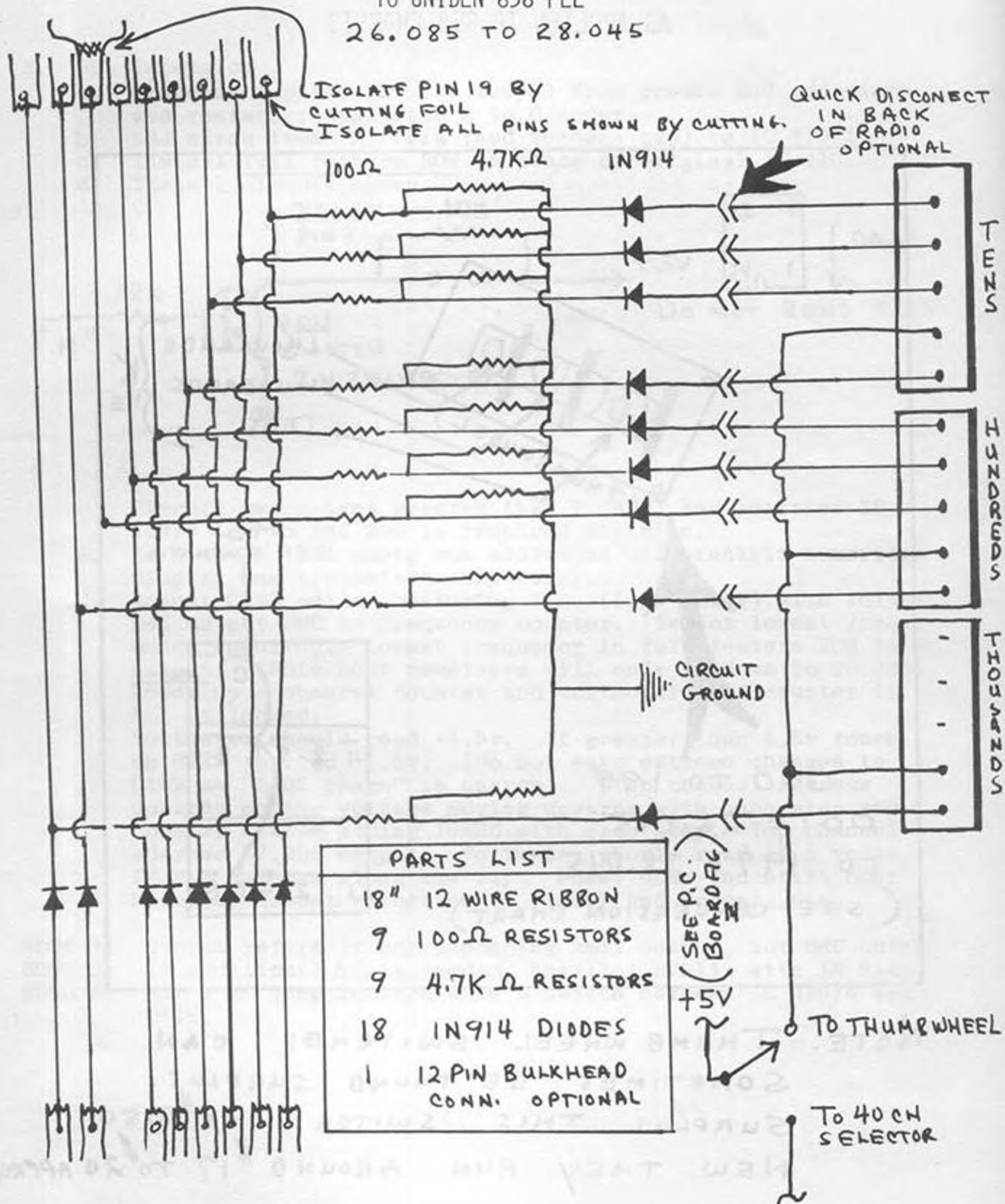

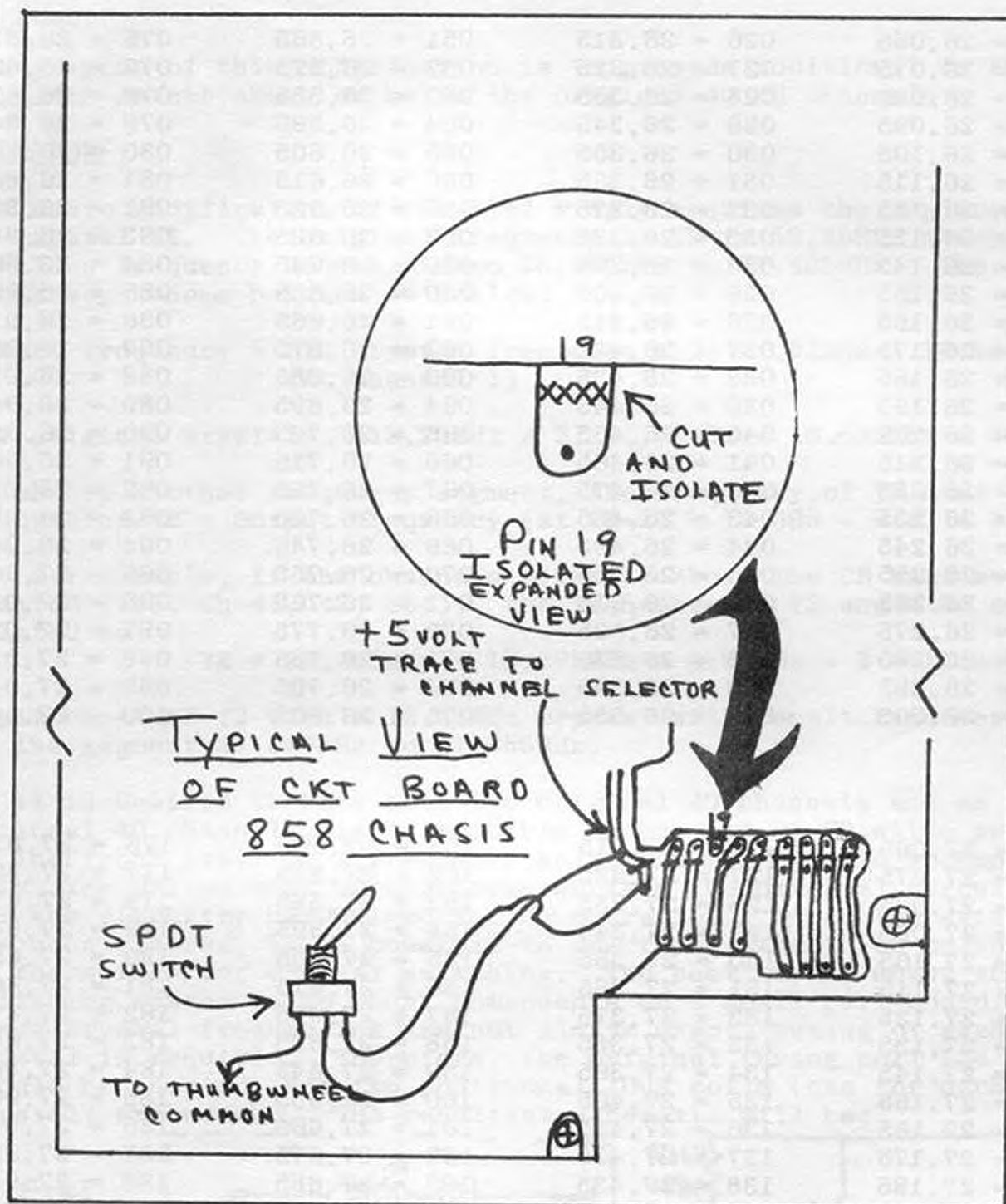

NOTE: You may use existing switch on radio. BE CAREFUL - THIS CAN GIVE YOU TROUBLE IF YOU ARE NOT USED TO USING AN EXISTING N.B. SWITCH ETC. A MINI TOGGLE WILL DO JUST FINE.

200 CHANNEL FREQ. CONVERSION CHART

| | | | |
|--------------|--------------|--------------|--------------|
| 001 = 26.065 | 026 = 26.315 | 051 = 26.565 | 076 = 26.815 |
| 002 = 26.075 | 027 = 26.325 | 052 = 26.575 | 077 = 26.825 |
| 003 = 26.085 | 028 = 26.335 | 053 = 26.585 | 078 = 26.835 |
| 004 = 26.095 | 029 = 26.345 | 054 = 26.595 | 079 = 26.845 |
| 005 = 26.105 | 030 = 26.355 | 055 = 26.605 | 080 = 26.855 |
| 006 = 26.115 | 031 = 26.365 | 056 = 26.615 | 081 = 26.865 |
| 007 = 26.125 | 032 = 26.375 | 057 = 26.625 | 082 = 26.875 |
| 008 = 26.135 | 033 = 26.385 | 058 = 26.635 | 083 = 26.885 |
| 009 = 26.145 | 034 = 26.395 | 059 = 26.645 | 084 = 26.895 |
| 010 = 26.155 | 035 = 26.405 | 060 = 26.655 | 085 = 26.905 |
| 011 = 26.165 | 036 = 26.415 | 061 = 26.665 | 086 = 26.915 |
| 012 = 26.175 | 037 = 26.425 | 062 = 26.675 | 087 = 26.925 |
| 013 = 26.185 | 038 = 26.435 | 063 = 26.685 | 088 = 26.935 |
| 014 = 26.195 | 039 = 26.445 | 064 = 26.695 | 089 = 26.945 |
| 015 = 26.205 | 040 = 26.455 | 065 = 26.705 | 090 = 26.955 |
| 016 = 26.215 | 041 = 26.465 | 066 = 26.715 | 091 = 26.965 |
| 017 = 26.225 | 042 = 26.475 | 067 = 26.725 | 092 = 26.975 |
| 018 = 26.235 | 043 = 26.485 | 068 = 26.735 | 093 = 26.985 |
| 019 = 26.245 | 044 = 26.495 | 069 = 26.745 | 094 = 26.995 |
| 020 = 26.255 | 045 = 26.505 | 070 = 26.755 | 095 = 27.005 |
| 021 = 26.265 | 046 = 26.515 | 071 = 26.765 | 096 = 27.015 |
| 022 = 26.275 | 047 = 26.525 | 072 = 26.775 | 097 = 27.025 |
| 023 = 26.285 | 048 = 26.535 | 073 = 26.785 | 098 = 27.035 |
| 024 = 26.295 | 049 = 26.545 | 074 = 26.795 | 099 = 27.045 |
| 025 = 26.305 | 050 = 26.555 | 075 = 26.805 | 100 = 27.055 |

| | | | |
|--------------|--------------|--------------|--------------|
| 101 = 27.065 | 126 = 27.315 | 151 = 27.565 | 176 = 27.815 |
| 102 = 27.075 | 127 = 27.325 | 152 = 27.575 | 177 = 27.825 |
| 103 = 27.085 | 128 = 27.335 | 153 = 27.585 | 178 = 27.835 |
| 104 = 27.095 | 129 = 27.345 | 154 = 27.595 | 179 = 27.845 |
| 105 = 27.105 | 130 = 27.355 | 155 = 27.605 | 180 = 27.855 |
| 106 = 27.115 | 131 = 27.365 | 156 = 27.615 | 181 = 27.865 |
| 107 = 27.125 | 132 = 27.375 | 157 = 27.625 | 182 = 27.875 |
| 108 = 27.135 | 133 = 27.385 | 158 = 27.635 | 183 = 27.885 |
| 109 = 27.145 | 134 = 27.395 | 159 = 27.645 | 184 = 27.895 |
| 110 = 27.155 | 135 = 27.405 | 160 = 27.655 | 185 = 27.905 |
| 111 = 27.165 | 136 = 27.415 | 161 = 27.665 | 186 = 27.915 |
| 112 = 27.175 | 137 = 27.425 | 162 = 27.675 | 187 = 27.925 |
| 113 = 27.185 | 138 = 27.435 | 163 = 27.685 | 188 = 27.935 |
| 114 = 27.195 | 139 = 27.445 | 164 = 27.695 | 189 = 27.945 |
| 115 = 27.205 | 140 = 27.455 | 165 = 27.705 | 190 = 27.955 |
| 116 = 27.215 | 141 = 27.465 | 166 = 27.715 | 191 = 27.965 |
| 117 = 27.225 | 142 = 27.475 | 167 = 27.725 | 192 = 27.975 |
| 118 = 27.235 | 143 = 27.485 | 168 = 27.735 | 193 = 27.985 |
| 119 = 27.245 | 144 = 27.495 | 169 = 27.745 | 194 = 27.995 |
| 120 = 27.255 | 145 = 27.505 | 170 = 27.755 | 195 = 28.005 |
| 121 = 27.265 | 146 = 27.515 | 171 = 27.765 | 196 = 28.015 |
| 122 = 27.275 | 147 = 27.525 | 172 = 27.775 | 197 = 28.025 |
| 123 = 27.285 | 148 = 27.535 | 173 = 27.785 | 198 = 28.035 |
| 124 = 27.295 | 149 = 27.545 | 174 = 27.795 | 199 = 28.045 |
| 125 = 27.305 | 150 = 27.555 | 175 = 27.805 | |

EXTENSION OF FREQUENCY COVERAGE ON PACE 8092

PURPOSE:

The purpose of this modification is to provide additional 40 channel segments either above or below the original 40 CB channels.

PROCEDURE:

The basic modification of the 8092 simply requires the replacement of crystal Y2. The original frequency of Y2 is 12.25MHz which provides frequency coverage from 26.965MHz to 27.405MHz. The frequency scheme behaves as follow:

$$\text{Output frequency} = (\text{Y2 crystal frequency} \times 3) + .91\text{MHz} - 10.695\text{MHz}$$

(At channel 1)

$$\text{For original crystal: } (12.25\text{MHz} \times 3) + .91\text{MHz} - 10.695\text{MHz} = 26.965\text{MHz}$$

To choose another frequency segment, the frequency of Y2 must be calculated. $Y2 = \text{Output frequency (at CH-1)} + 10.695 - 0.91 \div 3$

So, for example, if the channels directly above the CB band were desired (i.e. Ch-41, 42, etc.), the frequency of Y2 would be calculated as:

$$Y2 = 27.415\text{MHz} + 10.695\text{MHz} - 0.91\text{MHz} \div 3 = 12.40\text{MHz}$$

Replacement of Y2 with a 12.40MHz crystal will result in coverage of the segment 27.415MHz to 27.855MHz.

If it is desired to have both the original 40 channels and an additional 40 channels, it is possible to use the PA-CB slide switch on the front panel as a frequency selection switch. To accomplish this, the switch must be disconnected from the original circuitry and the circuitry hard-wired for CB operation. After the switch has been cleared, it is possible to use two of the three poles of the switch for crystal switching. The best way to mount the switching system is to mount components on a small perf-board. Since crystal frequencies are not always exact, tuning of each crystal is required. Therefore, the original tuning coil L34 should be shorted, and two additional 10uH coils (one for each crystal) are needed. The resultant schematic will be;

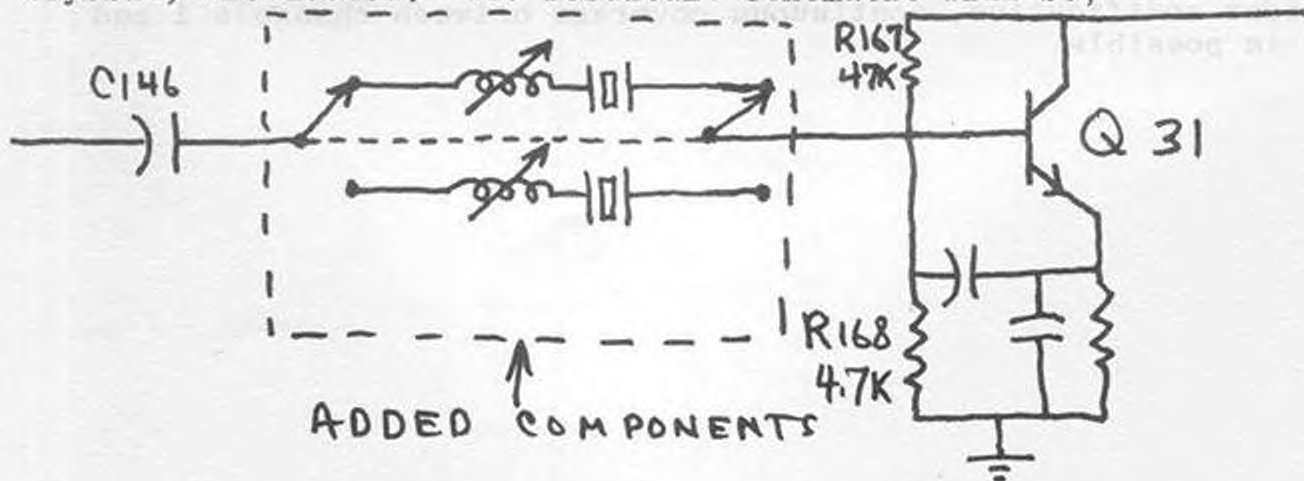

The circuit board should include the two crystals and two coils. The coil-crystal combinations are wired to the throws of the PC-CB switch. The wipers of the switch should be wired to the original Y2 mounting holes in the 8092 circuit board. The added circuit board should be installed as close to the PA-CB as possible and with wire as short as possible to minimize frequency variations caused by stray inductance.

Once the circuit is installed, the exact operating frequency must be adjusted. This can be done by transmitting and adjusting the two added coils for exact frequency. If the frequency will not adjust high enough, perform the following modification:

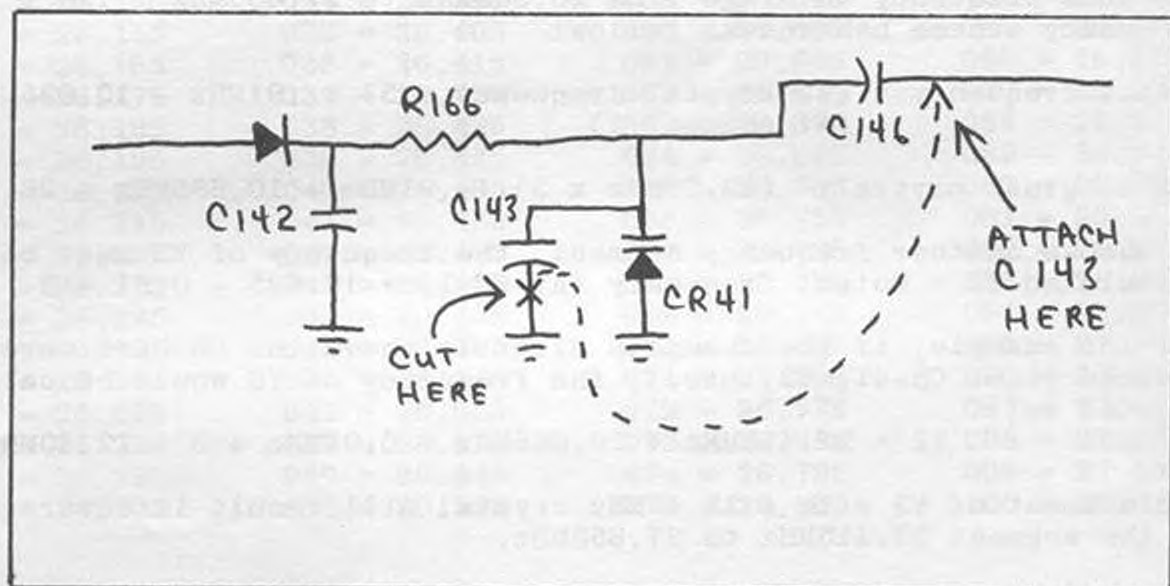

Remove C143 (10pF) and reposition it so it is wired in parallel with C146 (22pF). This will bring the frequency up several KHz. Readjust added coils for exact frequency.

Using the previous example, the PA-CB switch will now select channels 1 through 40 and 41 through 80 in the two positions of the switch.

When this modification is performed along with the transmitter slider modification, continuous coverage between channels 1 and 80 is possible.

SLIDER INSTRUCTIONS

- 1-Cut foil to disconnect R309 and R404 from RB (X-on schematic and parts locator).
- 2-Install uA 78L82, or equivalent, voltage regulator between ON/OFF switch and R309/404 junction. (See drawing on parts locator)
- 3-Bridge the junction CR49/R161/R162 to ground as shown.

The above will enable the clarifier to work on transmit (slider). In order to slide more than the standard clarifier range, it is necessary to make the following modifications and adjustments.

- 1-Remove C143 (10 or 15 pf).
- 2-Short (bridge) C146 (22pf).

Make the following slider frequency adjustments after the frequency modification is done.

- 1-Turn clarifier to maximum position fully clockwise.
- 2-Connect dummy load to antenna jack.
- 3-Connect frequency counter to dummy load (radio in AM mode) and key transmitter.
- 4-Adjust L34 for channel frequency (F_0 plus 10 KC).
- 5-Turn clarifier to maximum negative, fully counterclockwise.
- 6-Adjust R308 for F_0 minus 10 KC (if 10 KC cannot be reached, adjust for lowest frequency possible).
- 7-Repeat steps 5 thru 7 (if minus 10 KC cannot be reached and equal sliding is desired, adjust L34 to accomplish this, i.e., +9.5 KC and -9.5KC).
- 8-Check F_0 and if needed touch-up R309 to obtain the correct channel frequency.

NESCO 1249 CHANNEL CONVERSION

- 1-For increase in modulation remove Q201 from PC Board.
- 2-For best power band adjust L406 & L401 for maximum output while set for channel 10. Be sure to check for forward MOD.
- 3-Frequency MOD as shown. NOTE: Pin 3 is connected to pin 16 On foil side of the PC Board pin 3 must be cut free.

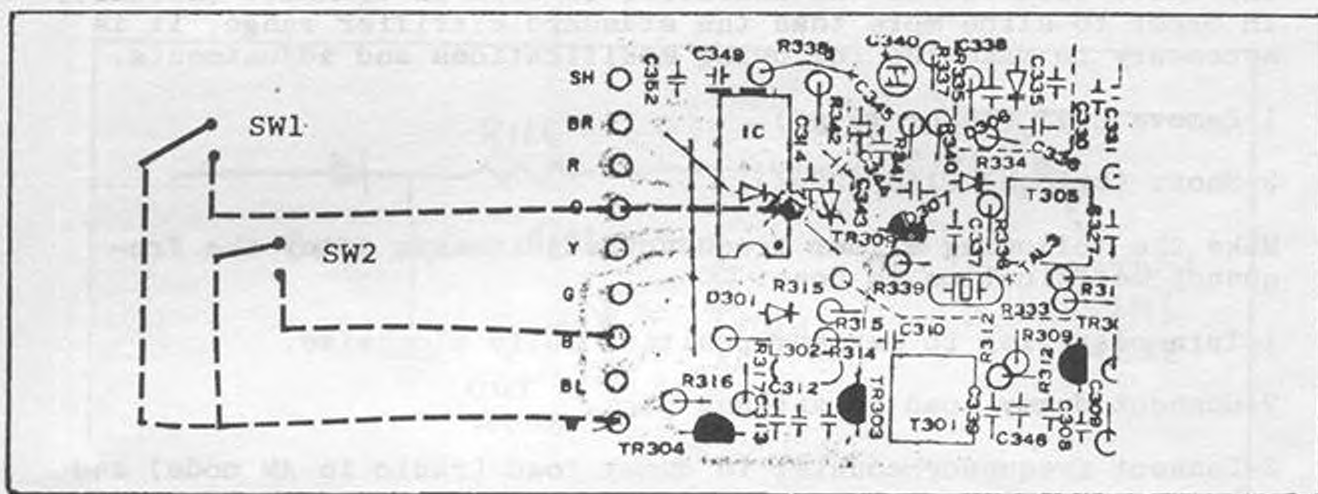

| HIGH FREQUENCIES | | LOW FREQUENCIES | | LOW FREQUENCIES | |
|------------------|-----------|-----------------|-----------|-----------------|-----------|
| SW1 & SW2 ON | | SW2 OFF SW1 ON | | SW2 OFF SW1 ON | |
| CHANNEL | FREQUENCY | CHANNEL | FREQUENCY | CHANNEL | FREQUENCY |
| 12 | 27.425 | 1 | 26.645 | 17 | 26.845 |
| 13 | 27.435 | 2 | 26.665 | 18 | 26.855 |
| 14 | 27.445 | 3 | 26.665 | 19 | 26.865 |
| 15 | 27.455 | 4 | 26.685 | 20 | 26.885 |
| 16 | 27.475 | 5 | 26.695 | 21 | 26.995 |
| 17 | 27.485 | 6 | 26.705 | 22 | 26.905 |
| 18 | 27.495 | 7 | 26.715 | 23 | 26.935 |
| 19 | 27.505 | 8 | 26.735 | 24 | 26.915 |
| 20 | 27.525 | 9 | 26.745 | 25 | 26.925 |
| 21 | 27.535 | 10 | 26.755 | 26 | 26.945 |
| 22 | 27.545 | 11 | 26.765 | 27 | 26.955 |
| 23 | 27.575 | 12 | 26.785 | | |
| 24 | 27.555 | 13 | 26.795 | | |
| 25 | 27.565 | 14 | 26.805 | | |
| 26 | 27.585 | 15 | 26.815 | | |
| 27 | 27.595 | 16 | 26.835 | | |

ADDENDUM TO FREQUENCY MOD FOR HALICRAFTERS

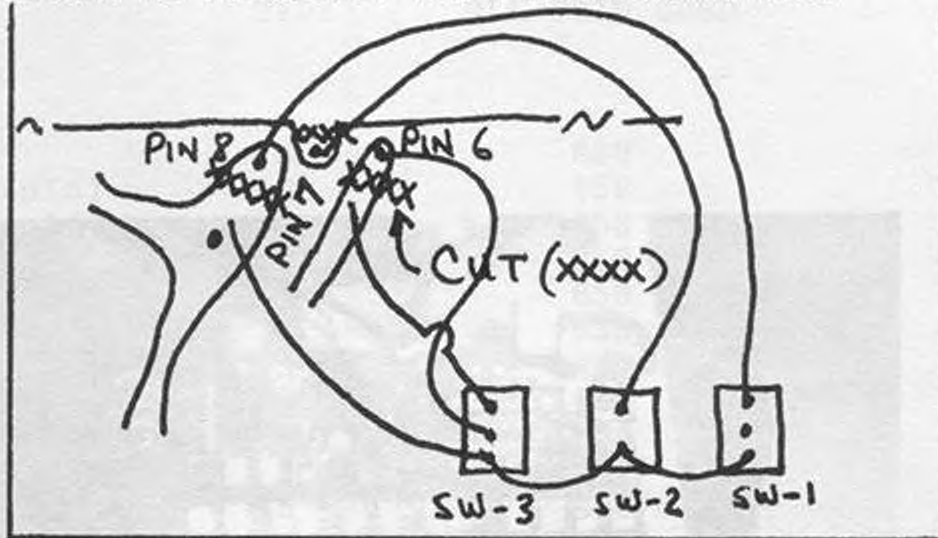

The addition of SW-3 will give: (SW-1 ON, SW-2 OFF, SW-3 ON)

| CHANNEL | FREQUENCY | CHANNEL | FREQUENCY |
|---------|-----------|---------|-----------|
| 1 | 27.285 | 21 | 27.535 |
| 2 | 27.295 | 22 | 27.545 |
| 3 | 27.305 | 23 | 27.575 |
| 4 | 27.325 | 24 | 27.555 |
| 5 | 27.335 | 25 | 27.565 |
| 6 | 27.345 | 26 | 27.585 |
| 7 | 27.355 | 27 | 27.595 |
| 8 | 27.375 | 28 | 27.285 |
| 9 | 27.385 | 29 | 27.295 |
| 10 | 27.395 | 30 | 27.305 |
| 11 | 27.405 | 31 | 27.315 |
| 12 | 27.425 | 32 | 27.325 |
| 13 | 27.435 | 33 | 27.335 |
| 14 | 27.445 | 34 | 27.345 |
| 15 | 27.455 | 35 | 27.355 |
| 16 | 27.475 | 36 | 27.365 |
| 17 | 27.485 | 37 | 27.375 |
| 18 | 27.495 | 38 | 27.385 |
| 19 | 27.505 | 39 | 27.395 |
| 20 | 27.525 | 40 | 27.405 |

NOTE 1

With SW-1 ON, SW-2 ON and SW-3 ON, channel positions 1-27 will give frequencies from 27.885 thru 28.195.

NOTE 2

You must use double pole switch for SW-3 in order to maintain normal operation.

REDCO APPLICATION AND TROUBLE SHOOTING
GUIDE

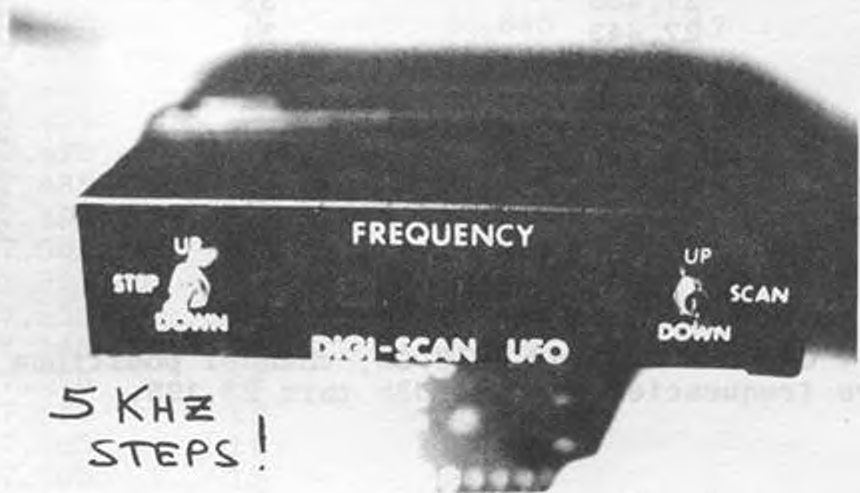
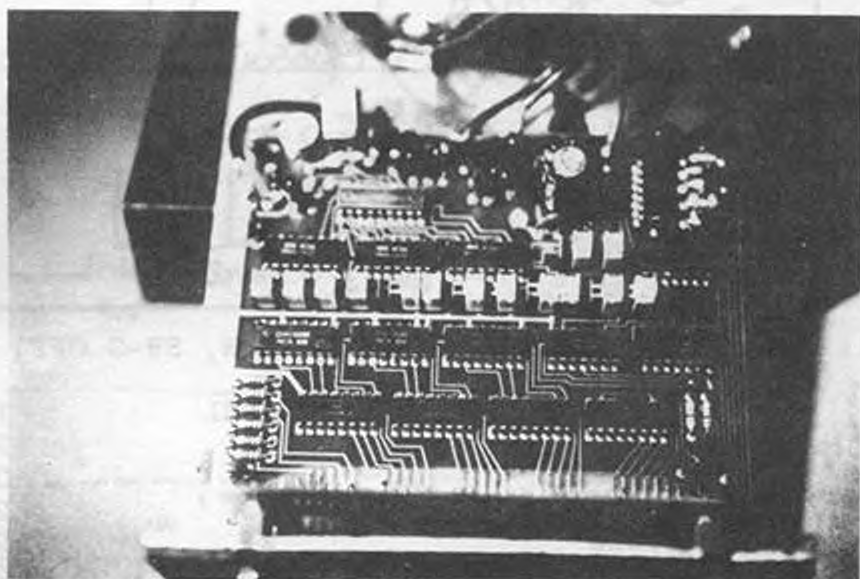

REDCO UFO APPLICATIONS

| MODEL | TYPE | PLL CHIP USED | DIGI-SCAN REQUIRED |
|------------------|------|---------------|--------------------|
| PRESIDENT | | | |
| Adams | S | 858 | RDS-1, UFO |
| Andrew J (old) | A | 858 | RDS-1, UFO |
| Dwight D (old) | A | 858 | RDS-1, UFO |
| Grant (old) | S | 858 | RDS-1, UFO |
| Honest Abe | A | 858 | RDS-1, UFO |
| John Q | A | 858 | RDS-1, UFO |
| Madison | S | 858 | RDS-1, UFO |
| Old Hickory | A | --- | N/A |
| Teddy R | A | 858 | RDS-1, UFO |
| Washington | S | 858 | RDS-1, UFO |
| Zachary T | A | 858 | RDS-1, UFO |
| Washington (new) | S | 8719 | RDS-6, UFP |
| Zachary T | A | 2816 | N/A |
| Dwight D | A | 2816 | N/A |
| Grant | S | 8719 | RDS-5, UFO |
| McKinley | S | 8719 | RDS-6, UFO |
| Andrew J | A | 2816 | N/A |
| Thomas J | A | 2816 | N/A |
| Veep | A | 9109 | N/A |
| Madison | S | 8719 | RDS-5 |
| COBRA | | | |
| 21 GTL | A | TC9106 | N/A |
| 21 XLR | A | 858 | RDS-1*, UFO |
| 25 GRL | A | TC9106 | N/A |
| 29 GTL | A | UPD2816 | N/A |
| 29 XLR | A | 858 | RDS-1*, UFO |
| 32 XLR | | 5080 | N/Z |
| 77 XLR | | 858* | UFO |
| 78 XLR | | 858* | UFO |
| 87 GTL | | 2816 | N/A |
| 89 GTL | | 2816 | N/A |
| 132 XLR | S | TC5080P | UFO-T |
| 135 XLR | S | TC5080P | UFO-T |
| 138 XLR | S | 858 | RDS-1, UFO |
| 139 XLR | S | 858 | RDS-1, UFO |
| 140 GTL | S | 8719 | RDS-6, UFO |
| 142 GTL | S | 8719 | RDS-6, UFO |
| 158 GTL | S | 8719 | RDS-5, UFO |
| 1000 GTL | A | 2816 | N/A |
| 2000 GTL | S | 8734 | RDS-5, UFO |

| MODEL | TYPE | PLL CHIP USED | DIGI-SCAN REQUIRED |
|------------------|------|---------------|--------------------------|
| COURIER | | | |
| Caravelle 40-D | A | 5104 | N/A |
| Conquerer 40-D | | SM5104 | N/A |
| Gladiator | S | 858 | RDS-1, UFO ¹⁰ |
| Spartan | S | 858 | RDS-1, UFO ¹⁰ |
| Centourian | S | 858 | RDS-1, UFO ¹⁰ |
| FANNON | | | |
| Fanfare 350-F | S | 858 | RDS-1, UFO |
| HY GAIN | | | |
| 623, 623A | S | Descrete | UFO ³ |
| MIDLAND | | | |
| 78-976 | S | PLL-02 | RDS-02, UFO |
| 78-999 | S | PLL-02 | RDS-02, UFO |
| 79-893 | S | 858 | RDS-1, UFO |
| 79-892 | S | PLL-02 | RDS-02, UFO |
| 79-900 | S | 8719 | RDS-6, UFO |
| 76-863 | A | PLL-02 | N/A 2 xtals |
| 78-892 | S | PLL-02 | RDS-02, UFO |
| BOWMAN | | | |
| CB-950 | S | PLL-02 | RDS-02, UFO |
| PALOMAR | | | |
| SSB-500 | S | 145106 | UFO ⁴ |
| SSB-500 | S | 7120 | UFO |
| 4100 | A | 02A | N/A 2 xtals |
| TEABERRY | | | |
| T Command | A | 858 | UFO, RDS-1 ¹ |
| Stalker 101 | S | 858 | RDS-1, UFO |
| Stalker 102 | S | 858 | RDS-1, UFO |
| Stalker 1 & 2 | S | Descrete | UFO |
| REALISTIC | | | |
| TRC-449 | S | 858 | RDS-1, UFO |
| TRC-455 | S | 858 | RDS-1, UFO |
| TRC-458 | S | 858 | RDS-1, UFO |
| TRC-457 | S | 858 | RDS-1, UFO |
| TRC-57 | S | Descrete | UFO ⁸ |
| ROBYN | | | |
| SB-505 | S | 8719 | 11.1125, RDS-6, UFO |
| SB-510D | S | 858 | RDS-1, UFO |

| MODEL | TYPE | PLL CHIP USED | DIGI-SCAN REQUIRED |
|--------------|------|---------------|--------------------------------------|
| ROBYN | | | |
| SB-505 | S | 8719 | 11.1125, RDS-6, UFO |
| SB-510D | S | 858 | RDS-1, UFO |
| SB-520D | S | 858 | RDS-1, UFO |
| SEARS | | | |
| 663.38060600 | A | 858 | RDS-1, UFO ¹ ₅ |
| 934.38110700 | S | SM5104 | UFO ⁵ |
| 934.38270700 | S | SM5104 | UFO |
| 934.28360700 | S | SM5104 | UFO |
| RCA | | | |
| 14T-303 | A | PLL-02 | N/A 2 xtal |
| NDI | | | |
| PC200 | S | NDC-40013 | UFO ⁶ |
| Johnson 9740 | S | NDC-40013 | UFO ⁶ |
| COLT | | | |
| 1200 | S | PLL-02 | RDS-02, UFO |
| 390 | | PLL-02 | N/A 2 xtal |
| 485 | S | PLL-02 | RDS-02 |
| GEMTRONICS | | | |
| 6TX-77 | S | PLL-02 | RDS-02, UFO |
| JC PENNEY | | | |
| 981-6247 | S | 02A | RDS-02, UFO |
| 981-6241 | S | SM5104 | UFO |
| PACE | | | |
| 1000NC | S | 40013 | UFO |
| LAFAYETTE | | | |
| SSB-140 | S | PLL-02 | RDS-02, UFO |
| TRAM | | | |
| D-62 | S | 5080 | UFO-T |
| D-80 | S | 8719 | RDS ₆ ⁵ , UFO |
| D-64 | S | NDC40013 | UFO |
| D-300 | S | 8719 | RDS-5, UFO |
| BROWNING | | | |
| Baron | S | TC5080P | UFO ₇ ^T |
| Mark IV | A | 145106 | UFO |
| SBE | | | |
| 27CB | S | Descrete | UFO ⁹ |
| 39CB | S | Descrete | UFO ⁹ |
| 40CB | S | Descrete | UFO ⁹ |
| SCOTT | | | |
| Dak 10 | S | PLL-02 | RDS-02, UFO |

REDCO UFO APPLICATIONS

TYPICAL PROBLEMS ENCOUNTERED WITH 8719 & 8734 SYNTHESIZERS:

1. DOWN MIXER OUTPUT SIGNAL (TP-10)

The Uniden 8719 & 8734 chassis have been found to have a relatively large difference in the amplitude of the down mixer signal available on TP-10. The UFO picks up this signal on Coax #1, amplifies the signal and compares it with an internal reference. Problems are encountered when the UFO does not get enough drive from the radio. This can cause an "out of lock" condition, and in this state the radio would be on some random frequency dependent only upon the FCO adjustment and not the UFO. To determine if an "out of lock" condition is caused by lack of drive, follow the procedure outlined on TA-002. A minimum of 3v peak to peak signal is required on Pin 2 for proper UFO operation. If the "out of lock" condition is caused by low drive, it can be cured by one of the following methods:

RADIO MODIFICATION

- a. Install a resistor from the base of TR-20 or Pin 10 of VCO chip to ground. This will improve the radio's gain by approximately 30%.

UFO MODIFICATION

- b. Short the capacitor (.01uf) connecting the amplifier to Pin 2 of the PLL chip. Remove the 4.7k resistor to the right of the .01uf cap previously mentioned and replace with a 68k resistor.

Modification b. has been put into production of all new UFO's being manufactured as of 5-5-79.

2. VCO ADJUSTMENT

For maximum range and a clean sounding radio it is highly recommended the VCO be aligned in the following manner:
(Note: Use a non-metallic alignment tool)

- a. Set UFO to 28,000 MHz.
- b. Turn the VCO adjustment to a point where the radio is near 27,950.
- c. Align the VCO slug very slowly until the VCO just locks at 28,000 and do not turn the VCO past this point.

Other alignment procedures may cause loop filtering adjustments to be very critical and the radio may not be clean over a wide range of frequencies.

3. LOOP FILTERING

The addition of a variable loop filter on 8719 & 8734 radios is occasionally a necessity. A variable loop filter allows the technician to vary the loop filtering and make up for variables present in synthesizer circuits of radios.

Symptoms of the loop filtering being incorrect may be: distorted SSB, warble on SSB, difficult to clarify SSB, or, in extreme cases, squeal on AM and bleedover may be present. In most cases the problems described above are most easily cured by the addition of a variable loop filter consisting of a variable resistor (usually a trimpot) in series with an electrolytic capacitor. Values of 10uf & 10k have been used here at the factory quite successfully. This loop filter is added between TP9 and ground.

Better results can be achieved by removing the capacitors inside the UFO which normally compose the loop filters. These capacitors are identified in the programming section of the instruction manual as they are removed for 858 installations. The loop filter is aligned for best SSB clarity. If the resistance of the trimpot is too low, the radio will warble on higher frequencies; and, if the resistance is too high bleedover may be experienced on lower frequencies.

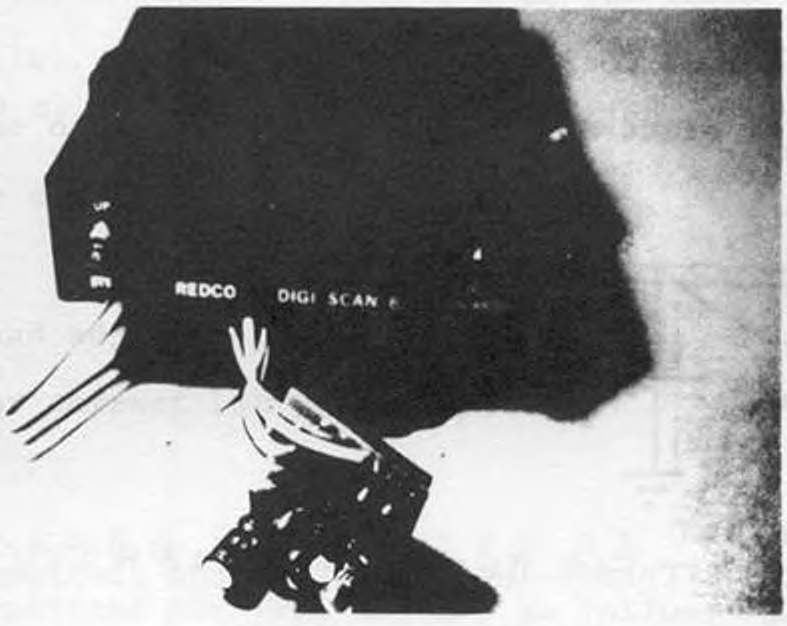

REDCO DIGI-SCAN 6

UFO INSTALLATION TO BROWNING MARK IV A

1. Do not remove 145106 PLL chip.
2. Connect the center of Coax 1 to the Junction of R-708 and R-709.
3. Remove R-715 and C-734.
4. Connect the center of Coax 2 to TP-3.
5. Install a 10uf cap and 10k pot in series from TP-3 to ground.
6. Remove loop filtering capacitors in UFO as in 858 installation.
7. Cut the foil trace connecting to Pin 8 of the 145106 chip.
8. Connect the foil trace that was connected to Pin 8 to an 8v source.

PROGRAM CODE: B B W W B B B B W W

UFO INSTALLATION TO REALISTIC TRC 57

1. Hook center of Coax 1 to TP-4 (Junction R321 and R322).
2. Remove the 10k resistor connecting to TP3.
3. Hook center of Coax 2 to TP3.
4. Add a 10uf electrolytic cap and a 10k pot in series from TP3 to ground.

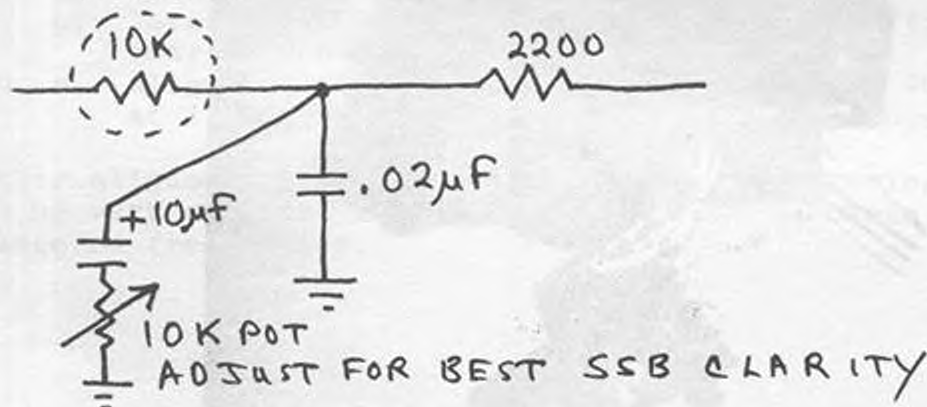

5. Align VCO for maximum range (L11)
6. Remove final RF amp.

PROGRAM CODE: W B B B W W B W B B B B W W

UFO INSTALLATION TO

HY-GAIN 623-A

1. Remove VCO shield (L-603).
2. Replace 330pf cap (C634) with 100 pf.
3. Remove R-308.
4. Hook center of Coax 2 to the side of R-308 that goes to the connector (VCO control).
5. Hook center Coax 1 to Pin 1 of IC 301.
6. Install a 10uf electrolytic cap and a 10k pot in series from the center of Coax 2 to ground.
7. Remove V-501.

PROGRAM CODE: B B B W W B W B B B B W W

UFO INSTALLATION TO

NDI-PC200

APPLICATIONS: Chassis using 40013 synthesizer Chip examples:
Tram D64, Pace 1000B, and Johnson 4740.

INSTALLATION:

1. Connect the center of Coax 1 to Pin 2 of the 40013 PLL chip.
2. Remove R-03 (1k).
3. Connect center of Coax 2 to the Junction R-02 and R-04.
4. Change 10.000 crystal Y1 to 10.240 MHz.
5. Remove CR-03.
6. Apply power and adjust L-5 for correct AM frequency.
7. Adjust L-6 for correct LSB frequency.
8. Remove Q705.

PROGRAM CODE: B B B B W B W W B B B B B B

NOTE: Part designations above refer to NDI-PC200.

Part designations for Tram D64 are as follow: R-03 - R-903,
R-02 - R-902, R-04 - R-904, CR-03 - CR-903,

PROGRAM CODE: D-64 B B W B B B W B W W W W W W

NOTE: USB will be 5 kc below the frequency display.

TROUBLESHOOTING AN OUT OF LOCK CONDITION

The following flow chart describes troubleshooting an out of lock condition. Align the VCO for an operating frequency about 200 KHz above the UFO setting. Program UFO correctly.

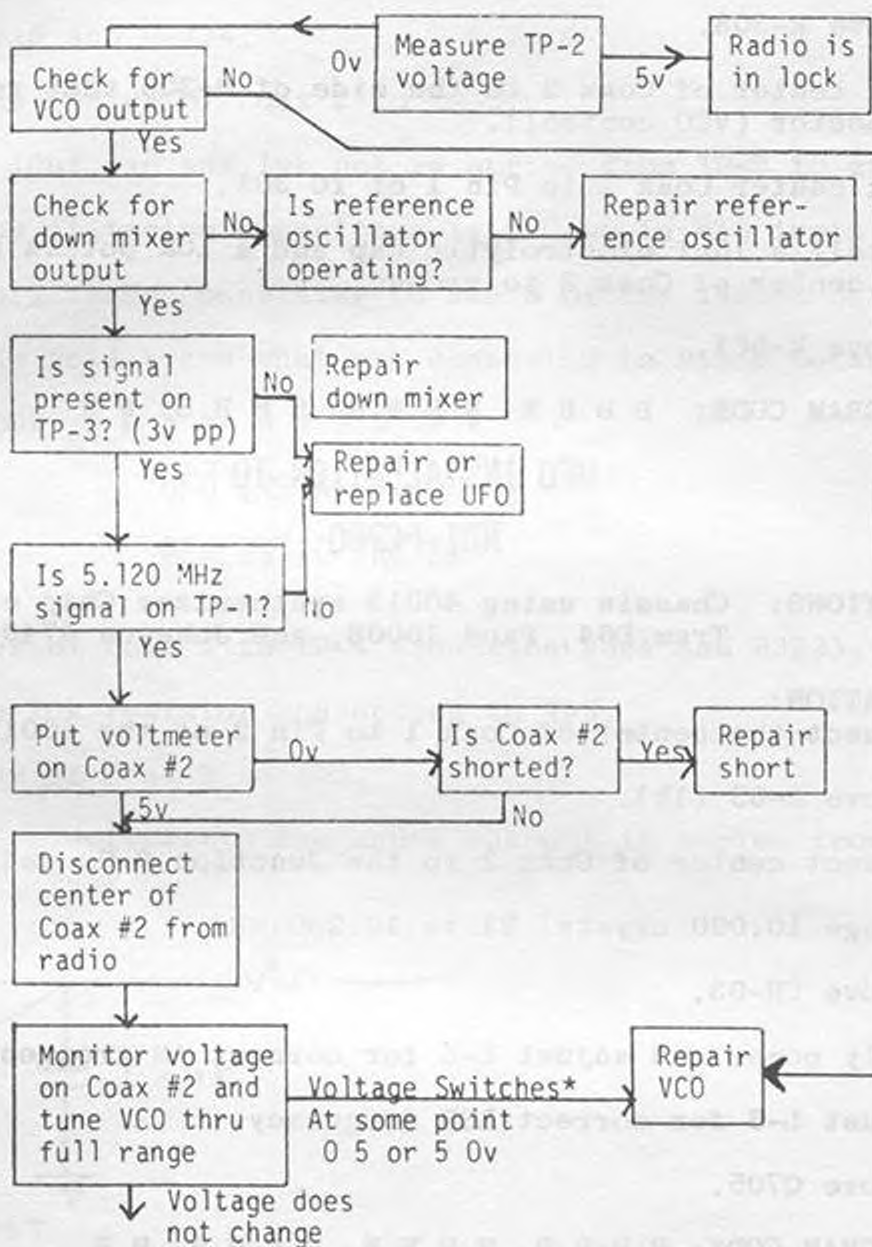

As the VCO is adjusted through the frequency displayed by the UFO, the voltage on Coax #2 should change its logic state.

OUT OF LOCK: In an "out of lock" condition varying the UFO frequency setting will not change the radio frequency. A voltage measurement on the TP-2 will quickly determine a locked or unlocked condition, 0v for locked, 5v for unlocked.

LIMITED RANGE: An "out of lock" condition at the top or bottom end of the band.

WARBLE: A warble is detected on SSB. This can cause SSB communications to be distorted or difficult to clarify.

RADIO OFF FREQUENCY BY A MULTIPLE OF 5KHz: Radio in lock but the operating frequency is constantly off by some multiple of 5KHz.

RECEIVES 2 OR MORE CHANNELS AT ONCE: When receiving, the same incoming signal can be heard on several frequencies.

WILL NOT LOCK WHEN POWER IS RESET: A radio may function normally after re-alignment, but, when the power is turned off and then turned on again, it may not relock. The reason this condition can exist is as follows: Power is first applied and the UFO circuitry has no input on Coax 1 because the VCO has not begun to oscillate. The UFO senses the lack of input and puts out a high (5v) state on Coax #2. The VCO then oscillates at its maximum frequency, and because of inherent design its amplitude decreases at higher frequencies; therefore, the down mixer output is low and the UFO cannot get enough drive from the radio on Coax #1. The PLL chip does not get enough drive and the loop is unable to recover. The problem is solved by increasing the gain of the down mixer or input amplifier or re-adjusting the VCO coil to a point where the VCO will not run as high in frequency. Use the VCO alignment suggested later in this text.

LOOP FILTERING: The addition of a variable loop filter on radios is occasionally a necessity. A variable loop filter allows the technician to vary the loop filtering and make up for variables present in synthesizer circuits of radios.

Symptoms of the loop filtering being incorrect may be: distorted SSB, warble on SSB, difficult to clarify SSB, or, in extreme cases, squeal on AM and bleedover may be present. In most cases the problems described above are most easily cured by the addition of a variable loop filter consisting of a variable resistor (usually a trimpot) in series with an electrolytic capacitor. Values of 10uf and 10k have been used here at the factory quite successfully. This loop filter is added between the center of Coax #2 and ground.

Better results can be achieved by removing the capacitors inside the UFO which normally compose the loop filter. These capacitors are identified in the programming section of the instruction manual as they are removed for 858 installations.

The loop filter is aligned for best SSB clarity. If the resistance of the trimpot is too low, the radio will warble on higher frequencies; and, if the resistance is too high, bleedover may be experienced on lower frequencies.

GROUND CONNECTIONS: For proper operation the UFO must have a good ground loop to the radio. Best results are achieved by connecting the shields near the VCO and connecting the black wire to a ground near the voltage regulator.

BROKEN PC PADS: The pads under the PLL chip are sometimes damaged during chip removal. The 8v source is connected through one of the pads and the circuit must be complete through the pad to attain a locked condition on 8719 installations.

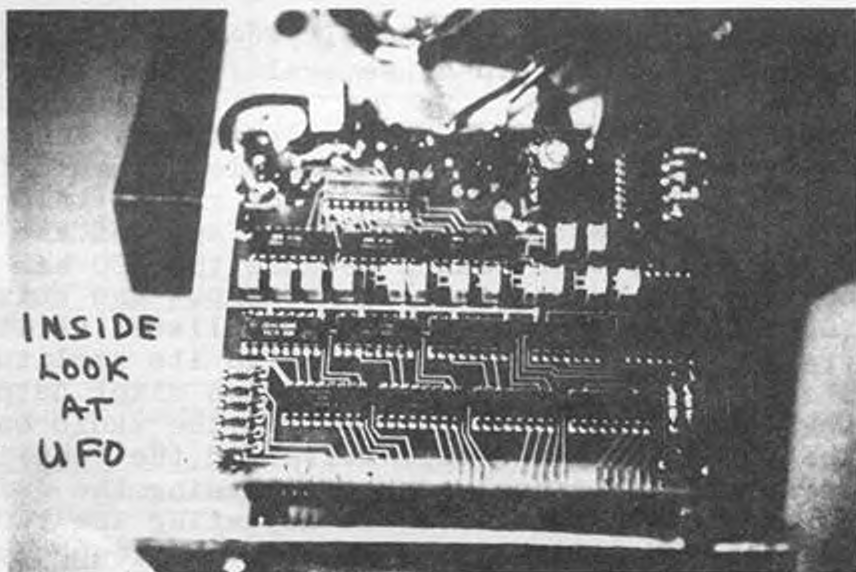

5 KHZ STEPS!

REDCO
MODEL MARK IV

The REDCO MARK IV RF Monitor is a high quality instrument for measuring Standing Wave Ratio (SWR), Transmitted power and percent modulation.

REDCO'S MARK IV is designed by Redco/Conductron for CB and Ham radio applications. Power scales are factory calibrated at 26MHz, (if desired the three power scales can be individually calibrated for any frequencies between 1Mhz and 250Mhz.).

The SWR and Modulation functions are broad-band and will operate from 1Mhz to 250Mhz.

THE MARK IV FEATURES:

RF power scales of 0-10, 0-100, 0-1000 watts, 5% accuracy

SWR scale displays SWR and percent reflected power.

Modulation displayed in % and decibels (-21db to +3db)

Precision 6-inch D'Arsonval multiscale meter, 5ua, 2% accuracy

Directional forward power/reflected power discrimination= 30db (i.e. 1000 times)

Completely passive, requires no external power source

Inline operation. Will not disturb the tuning of your antenna system. Draws negligible power.

Uses standard UHF coaxial connectors.

REDCO'S Digi-Scan systems are manufactured as receiving systems only, and to use them for transmission in the United States is in direct violation of the Federal Communications Commission.

REDCO
MODEL MARK V

REDCO'S MARK V wattmeter is a 3 meter system to allow continuous monitoring of RF Power, SWR and modulation.

For accuracy and reliability a calibrated dial on the front panel can be set to any frequency from 3 Mhz to 250 Mhz. A frequency selector switch is provided to allow you to set your dial on any frequency you would like to operate within the spectrum frequencies of 50, 100, 150, 200, and 250Mhz. A special channel provided for CB operating frequencies.

Only REDCO/CONDUCTRON could design and manufacture such a technological breakthrough in the wattmeter field.

FEATURES:

- 1-The ultimate broad band from 3Mhz to 250Mhz, AM, CW, SSB operations
- 2-A passive system, no external power required
- 3-Unique solid state design provides negligible insertion loss 100%. Modulation readout extends from -20db to +3db. Modulation is a function of voice level. (This level can be adjusted to read 100% for best communication transmission).
- 4-Standing Wave Ratio readout is indicated on the SWR meter by means of a unique design balanced bridge circuit, termination 50 Ohms (forward and reflected power ratio).
- 5-MARK V is simple to connect to your transceiver system by 2 coaxial connectors, and is inserted between the antenna and transmitter.

SPECIFICATIONS:

Frequency range*****3MHz to 250MHz in 50MHz steps
Power*****1000 watts CW, AM and 2000 watts Peak
ENVELOPE POWER (SSB)
Power consumption*****Passive & negligible
Modulation*****100%, -21db to +3db
SWR*****forward and reflective power ratio
to 1:3 and over
Meter movement*****three 3" D'Arsonval movement
of 2% accuracy
Factory calibrated*****from 3Mhz to 250Mhz
Accuracy*****Better than 5%
Size*****10" x 4½" x 4"

SPECIAL SECTION ON LINEAR AMPLIFIERS

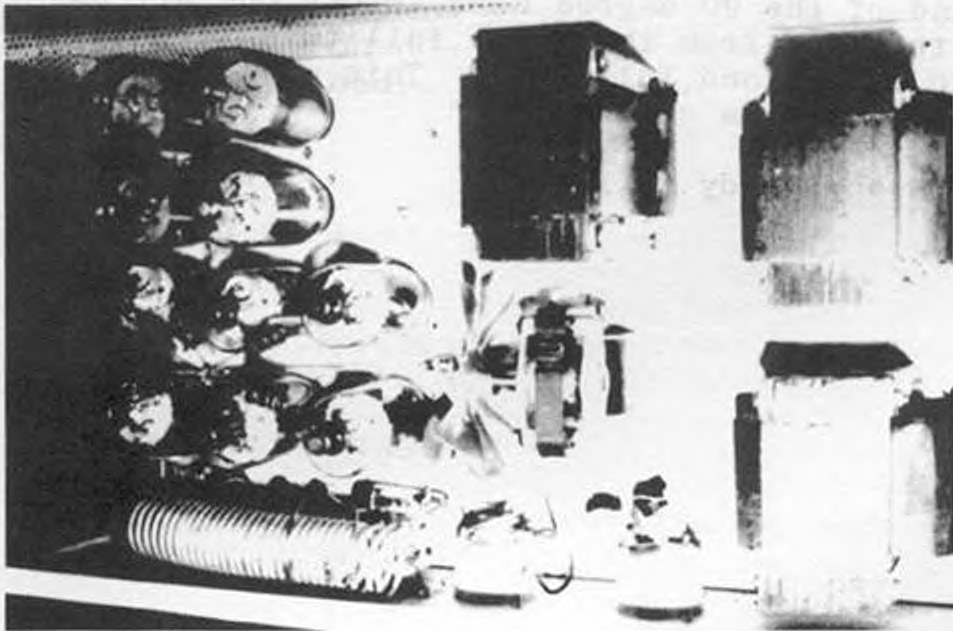
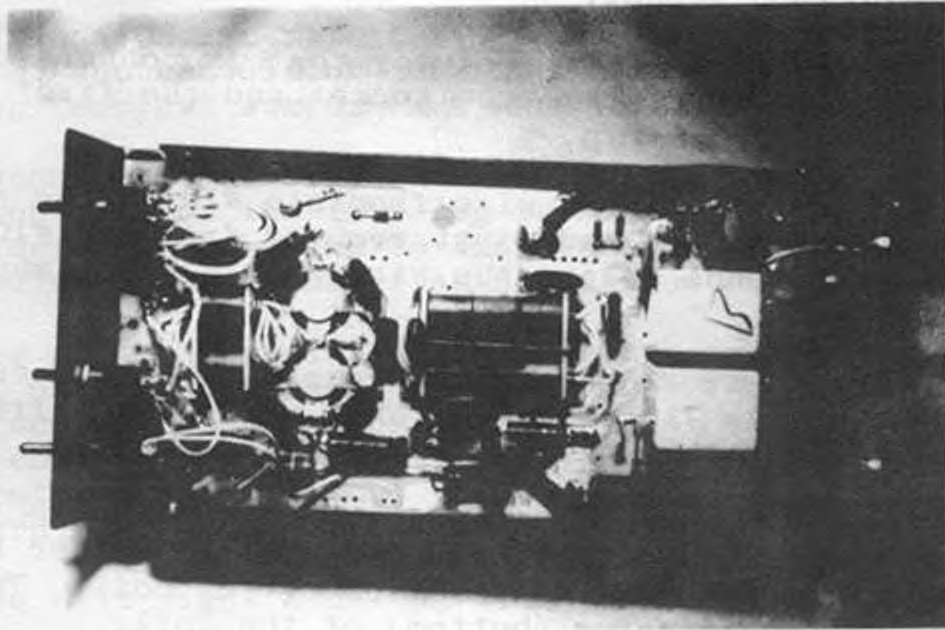

PDX-400

1. Turn the unit upside down with the front toward you.
2. Remove the insulated wire and the 5pf disc capacitor that is connected between the VFO (SO-239) and pin #2 of the oscillator tube socket.
3. Remove the 470K two watt resistor that is connected between pin #1 of the oscillator tube socket and the first lug of the five lug terminal strip.
4.
 - a. Disconnect the brown wire from pin #10 of the antenna relay.
 - b. Solder the loose end, just removed from pin #10, to pin #6 of the antenna relay; the wire should be as short as possible.
5. Solder a piece of #18 or larger copper wire between the VFO (SO-239) and pin #10 of the antenna relay; the wire should be as short as possible.
6. Starting at the bottom of the driver stage tank coil (at the tune control on the right hand end) bridge solder (going from right to left) across two air gaps of the coil. This will be done on the interior (bottom) of the coil.
7. Turn the unit right side up, with the front toward you.
8. Starting at the bottom of the final stage tank coil (at the load control on the left hand end) bridge solder (going from left to right) across two air gaps of this coil. Solder from the end of the 90 degree bend across one air gap to the first full turn and from the first full turn across the second air gap to the second full turn. This will be done on the interior (bottom) of this coil.
9. Unit is now ready to load.

D & A 250 MAVERICK

1. Turn the unit upside down with the front toward you.
2. Remove the insulated wire and 5 pf disc capacitor that is connected between the VFO input SO-239 and pin #2 of the oscillator tube socket.
3. Remove the 470K two watt resistor that is connected between pin #1 of the oscillator tube socket and the first lug of the five lug terminal strip.
4.
 - a. Disconnect the brown wire where it is connected to the second lug of the five lug terminal strip.
 - b. Solder the loose end to the VFO input SO-239. (Wire should be cut as short as possible).
5. Starting at the top of the driver stage tank coil, (load control or left hand end) bridge solder (going from left to right) across two air gaps of this coil. Solder from the end of the coil across one air gap to the first full turn and from the first full turn across the second air gap to the second full turn.
6. Turn the unit right side up, with the front toward you.
7. Starting at the bottom of the final stage tank coil, (load control or left hand end) bridge solder (going from left to right) across two air gaps of this coil. Solder from the end of the 90 degree bend across one air gap to the first full turn and from the first full turn across the second air gap to the second full turn. This will be done on the interior (bottom) of this coil.
8. Unit is now ready to load.

THE DUSTER 300, 750, & 1000 TRANSMITTER

Remove transmitter board as follows:

1. Remove capacitor at relay board.
2. Remove jack from front panel with wire attached.
3. Remove wire from bilateral switch on front panel.
4. Remove board with attached parts.

It is rumored that the factory will swap transmitter boards for a 2057 tube.

To get unit to Transmit do the following:

1. Remove insulating sleeve from between the SO-239 (radio) connector, where the cap was removed, and the relay board.
2. Solder center of the SO-239 to pad on the relay board.

MACO 75

1. First change tube to 2057 and then remove bottom.
2. Take out and throw away brown wire connected to 10K resistor which runs from relay to PC board.
3. Take out, turn around, and re-install the glass diode on the foil side of the PC board.
4. Two wires going to the relay are reversed, they are the coax and the yellow wire going to the purple coil. Remove and reverse and reconnect.
5. Replace the bottom and key the radio, whistle, and tune front control for maximum.

NOTE: Dead key, no modulation should be 4-6 watts, if more adjust pot on bottom for this output.

NOTE ON MACO 75's:

With Bilateral Not Connected

1. Take off the jumper from across the lugs on the rear relay.
2. Connect the red wire to bottom empty pin on the stand by switch.
3. The black wires on bilateral board must be connected. Connect the wire directly below the red wire to the relay lug nearest the antenna connector. This lug had the jumper on it originally.
4. The other black wire goes to the other lug on the relay nearest radio connector. This had the other end of the jumper on it.
5. The wire with the green choke goes to the same relay lug as black wire, nearest radio connector as in (4).
6. This connects the Bilateral.

With Bilateral Connected, But Not Operational

1. Take off the jumper from across the lugs on the rear relay.
2. This enables the Bilateral.

It is essential that the Maco 500 be tuned and operated properly! Failure to do so will damage this product and is not covered by warranty!

DO'S

1. Do tune side control in the low position for maximum while whistling.
2. Do tune front load and tune controls for maximum in the HI position, while whistling.

DO NOT

1. Retune side control after it is once set!
2. Do not detune the front for any reason, always set for maximum.
3. Do not for any reason operate in SSB position on Maco 500 with radio on AM, this product has special circuitry for SSB, which if operated with radio in AM will destroy the driver tubes. Repeat, with radio in AM the 500 must be in AM.
4. Do not drive with over four watts AM under any conditions. If you overdrive, it is at your peril. If this was a 750 we would sell it at the 750 price!

CONVERSION: Instructions same as Maco 300. Later versions will be the same instructions as 750.

TUNING: If you are not familiar with the front tuning, it is done as follow:

1. Turn the front load control all the way to the left; key, whistle and set tune for maximum output. Then turn load control to the right while whistling, adjust tune for maximum. Continue this adjusting load and tune for maximum output.

500CX AND 700CX 10 TO 11 METER CONVERSION

1. Remove VFO cover and locate 10 meter VFO coil. Solder a 5 pf NPO capacitor in parallel with the existing 2.5 pf capacitor.
2. Replace cover and secure the screws.
3. Using a calibrated source such as a signal generator or crystal controlled CB transmitter and with the tuning dial of the 500CX set to zero, adjust the variable trimmer C-17170, capacitor so that channel #1, (28.020) coincides with this mark. Place signal source on channel #23 and adjust dial of 500CX. It should read approximately 28.350. If proper tracking has not been obtained; remove cover, take out 10 pf NPO and replace with 15 pf NPO capacitor and repeat calibration.
4. After proper tracking and calibration is obtained, it is suggested that some type of coil dope be applied to the area of the coil and capacitor so that they acquire a measure of mechanical rigidity to reduce possibility of drift.

The following coils will have to be repeaked: L-101, L-203, and L-301.

5. Set the transceiver on channel #13 and connect dummy load to it.
6. With the receiver on receive and using the DC scale of a VTVM, connect the negative lead to pin #1 of V-7, the receiver mixer, and the positive lead to ground. Adjust L-101 to the maximum negative DC reading.
7. Load set using the instructions given in manual for tuning.
8. Insert approximately 150 MA of carrier by adjusting carrier balance control, and peak L-203 and L-301 for maximum indication on watt meter.
9. The alignment is now complete, but neutralization will probably be required and this is accomplished by using the method described in the manual for 10 meters excepting that the transceiver dial is set on channel #13.

RDX-75

1. Turn the unit upside down with the front toward you.
2. Remove the 5pf disc capacitor that is connected between the VFO input (SO-239) and pin #2 of the oscillator tube socket.
3. Remove the 470K two watt resistor that is connected to pin #1 of the oscillator tube socket and the first lug of the 5 terminal strip.
4. a. Disconnect the brown wire where it is connected to pin #7 of the antenna relay and reconnect it to pin #4 of the antenna relay.
b. Solder a piece of #18 or larger copper wire from the VFO input (SO-239) to pin #7 of the antenna relay (wire should be as short as possible.)
5. Starting at the top of the tank coil (load control on left hand end) bridge solder from the end of the coil across one air gap to the first full turn and then across the second air gap to the second full turn.
6. Unit is now ready to load.

HDX-50

1. Turn the unit upside down with the front toward you.
2. Remove the 5pf disc capacitor that is connected between the VFO input (SO-239) and pin #2 of the oscillator tube socket.
3. Remove the oscillator tube, the 6GK6.
4. a. Disconnect the brown wire where it is connected to pin #7 of the antenna relay and reconnect it to pin #4 of the antenna relay.
b. Solder a piece of #18 or larger copper wire from the VFO input (SO-239) to pin #7 of the antenna relay (wire should be as short as possible.)
5. Starting at the top of the tank coil (load control on left hand end), bridge solder from the end of the coil across one air gap to the first full turn.
6. Unit is now ready to load.

1. Turn the unit upside down with front toward you.
2. Remove the insulated wire and the 5pf disc capacitor that is connected between the VFO input (SO-239) and pin #2 of the oscillator tube socket.
3. Remove the 470K 2 watt resistor that is connected between Pin #1 of the oscillator tube socket and the first lug of the five lug terminal strip.
4.
 - a. Disconnect the brown wire where it is connected to the second turn of the oscillator tank coil.
 - b. Solder the loose end to the VFO (SO-239); wire should be cut as short as possible.
5. Starting at the top of the driver stage tank coil, (load control on left hand end) bridge solder (going from left to right) across two air gaps of this coil. Solder from the end of the coil across one air gap to the first full turn and from the first full turn across the second air gap to the second full turn.
6. Turn the unit right side up, with the front toward you.
7. Starting at the bottom of the final stage tank coil (load control on left hand end) bridge solder (going from left to right) across two air gaps of this coil. Solder from the end of the 90 degree bend across one air gap to the first full turn and from the first full turn across the second air gap to the second full turn. This will be done on the interior (bottom) of this coil.
8. Unit is now ready to load.

PDX-400 LINEAR AMPLIFIER

1. Turn the unit upside down with the front toward you.
2. Remove the insulated wire and the 5pf disc capacitor that is connected between the VFO (SO-239) and pin #2 of the oscillator tube socket.
3. Remove the 470K two watt resistor that is connected between pin #1 of the oscillator tube socket and the first lug of the 5 lug terminal strip.
4.
 - a. Disconnect the brown wire from pin #10 of the antenna relay.
 - b. Solder the loose end, just removed from pin #10, to pin #6 of the antenna relay; the wire should be as short as possible.
5. Solder a piece of #18 or larger copper wire between the VFO (SO-239) and pin #10 of the antenna relay; the wire should be as short as possible.
6. Starting at the bottom of the driver stage tank coil (at the tune control on the right hand end) bridge solder (going from right to left) across two air gaps of the coil. This will be done on the interior (bottom) of the coil.
7. Turn the unit right side up, with the front toward you.
8. Starting at the bottom of the final stage tank coil (at the load control on the left hand end) bridge solder (going from left to right) across two air gaps of this coil. Solder from the end of the 90 degree bend across one air gap to the first full turn and from the first full turn across the second air gap to the second full turn. This will be done on the interior (bottom) of this coil.
9. Unit is now ready to load.

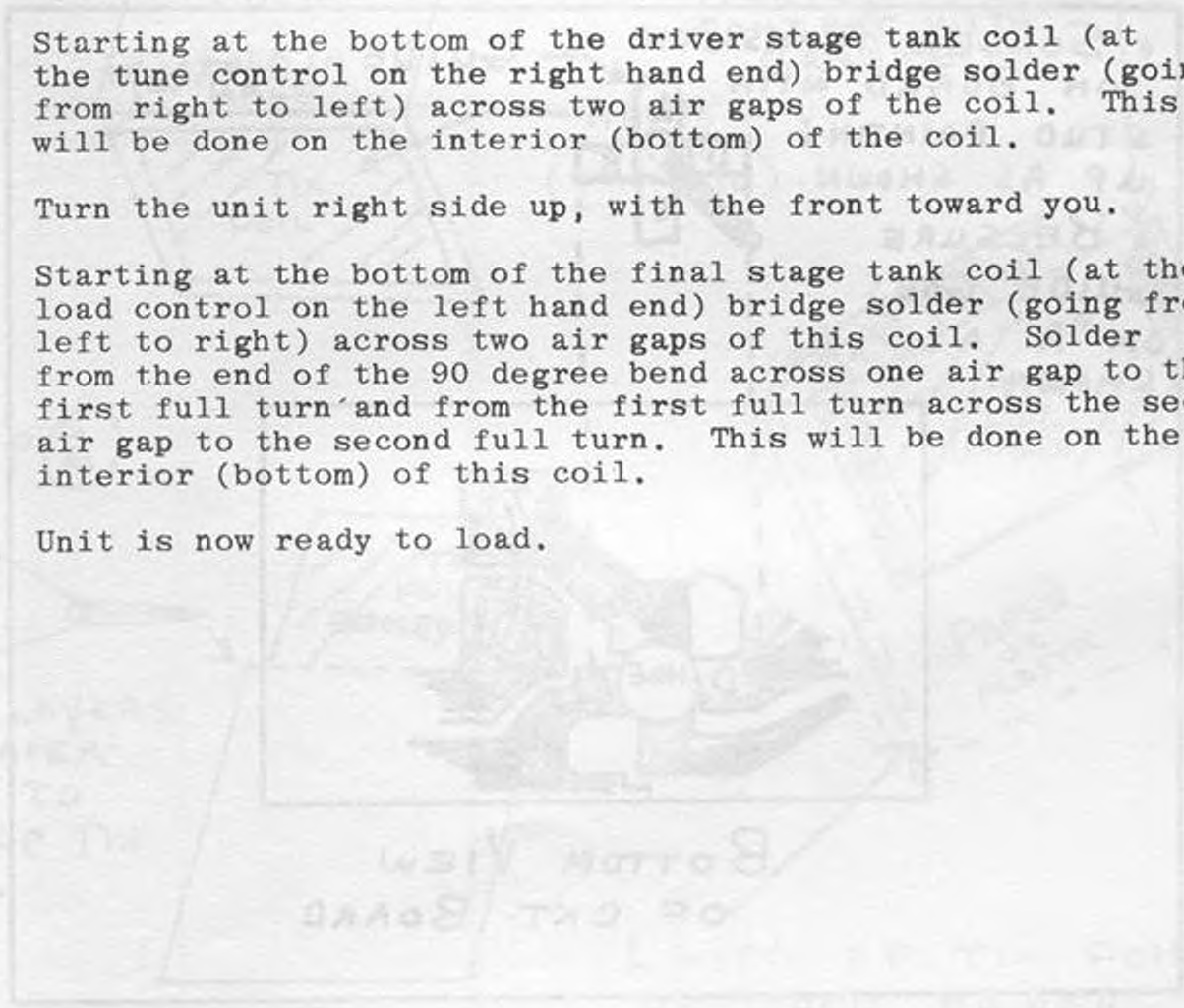

10 METER AMATEUR KIT
EXPERIMENTER BOARD INFO SHEET

INSTRUCTIONS:

The transistor is pre-cut and pre-tested. You must mount the transistor and solder it in place as shown. If the device is not installed correctly, it will result in immediate destruction of \$19.95. So, it is important to install it right the first time.

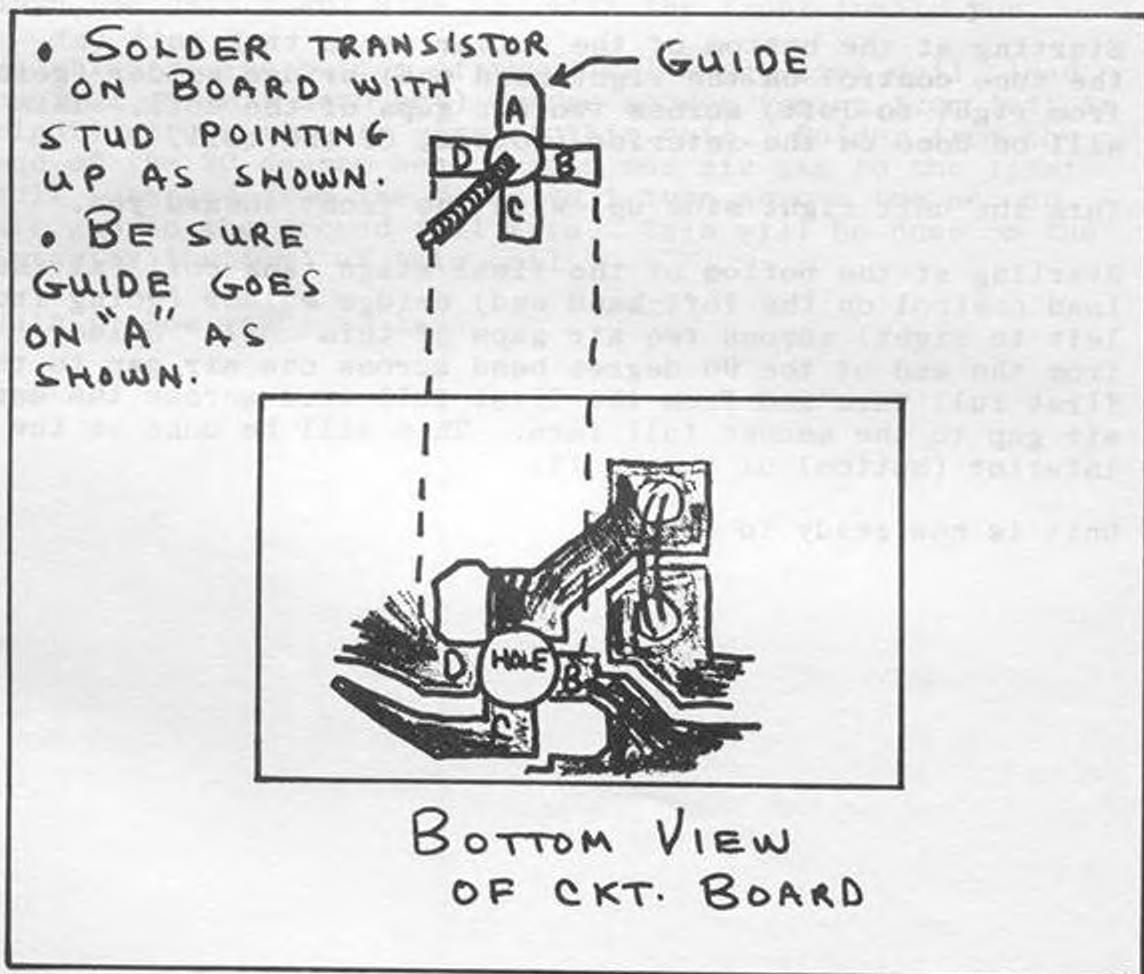

We have found that when installing the 10 meter unit in the radio you need to have additional shielding between the amp and the radio component's to prevent feed back. This may be accomplished by using a piece of aluminum foil wrap and inclosing it between a piece of note book paper. Fold the paper in half and insert the foil wrap between the folded paper, tape or staple and insert the shield between the amp and the radio. Fold the excess over the heat sink and tape the foil so it grounds out on the heat sink or the chassis. You must tear the paper off one end so you can expose the foil in order to ground it to the chassis or heat sink. Be sure the paper covers all parts that might short out. See illustration below:

STEP ①

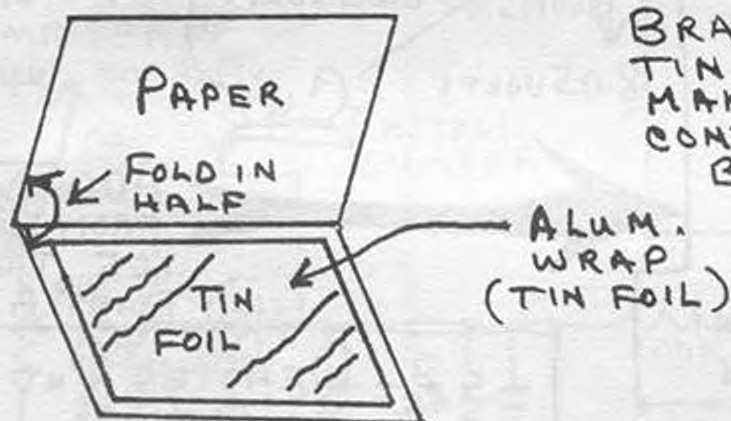

STEP ②

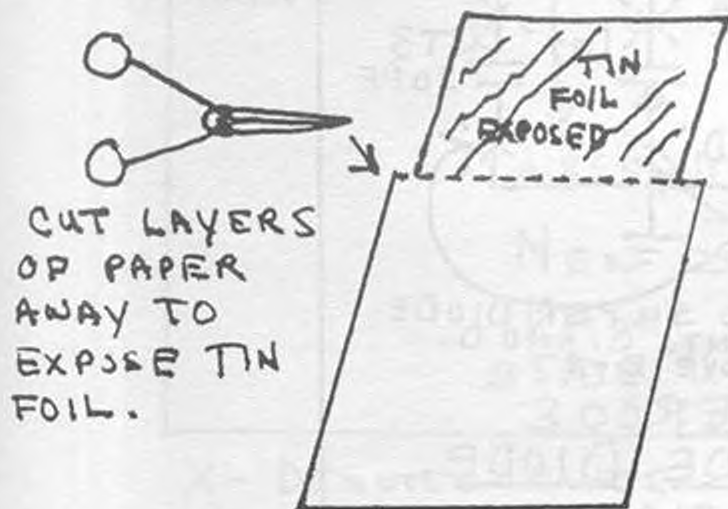

STEP ③

AMP MOUNTING BRACKET, NOTICE TIN FOIL LAYER EXPOSED MAKING CONTACT WITH BRACKET.

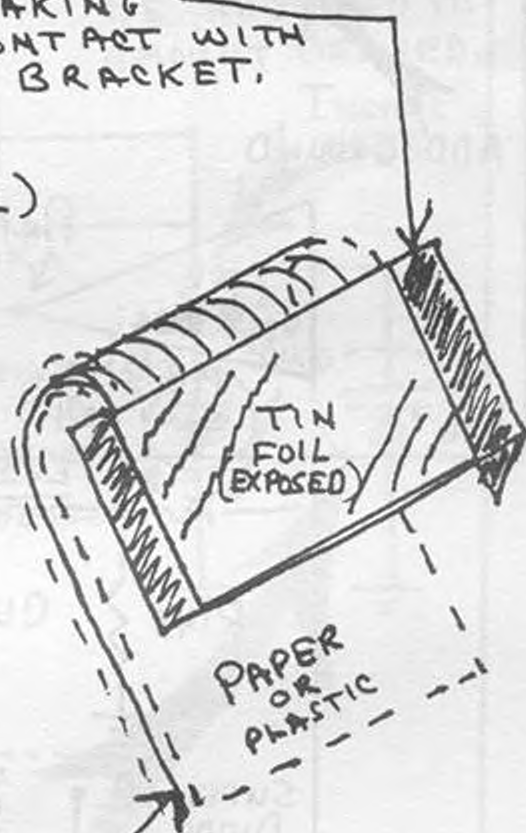

LAYER OF TIN FOIL BETWEEN PAPER

SLIDE MODIFICATION WITH 8719 CHIP

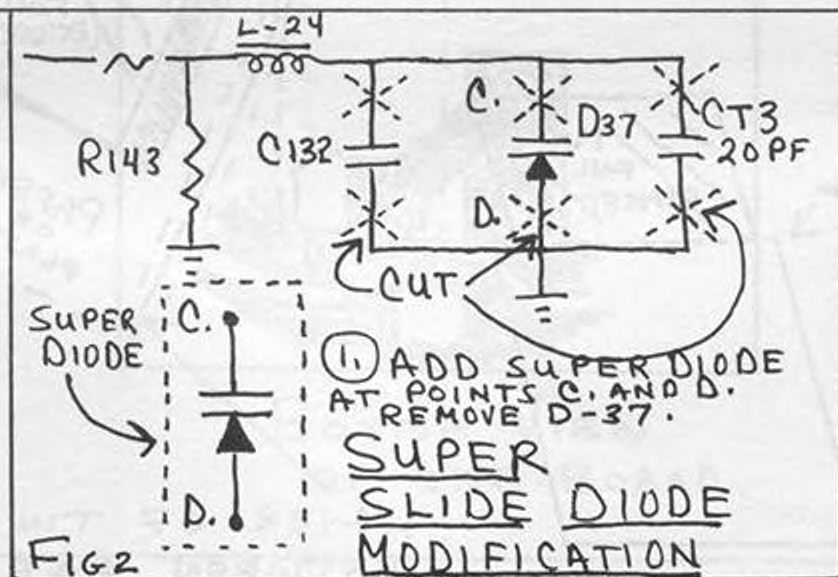
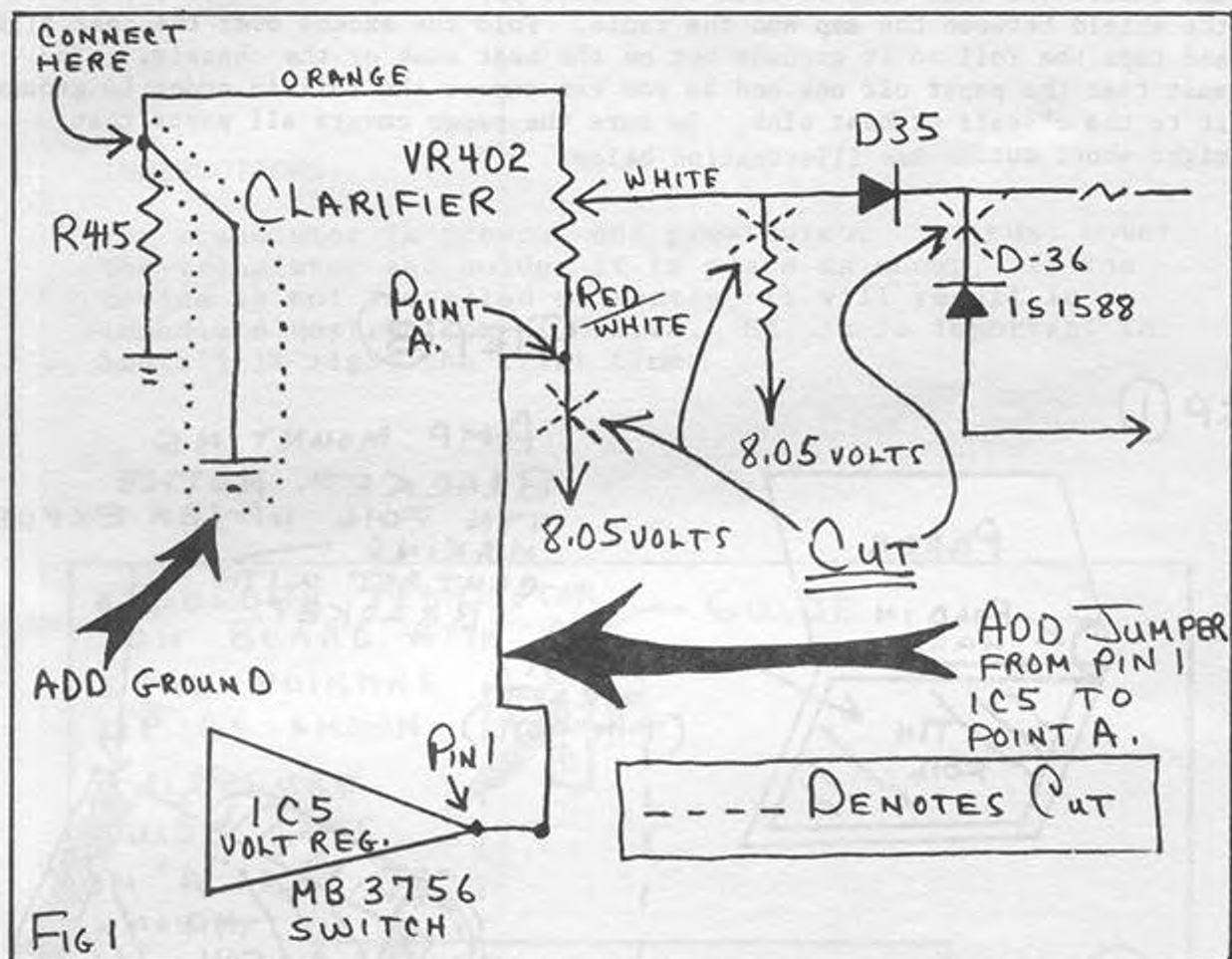

HOW TO MAKE ANY CYBERNET CHASSIS SLIDE
AS APPLIED TO SOME
JC PENNEY, SEARS ROADTALKER, AND MORE

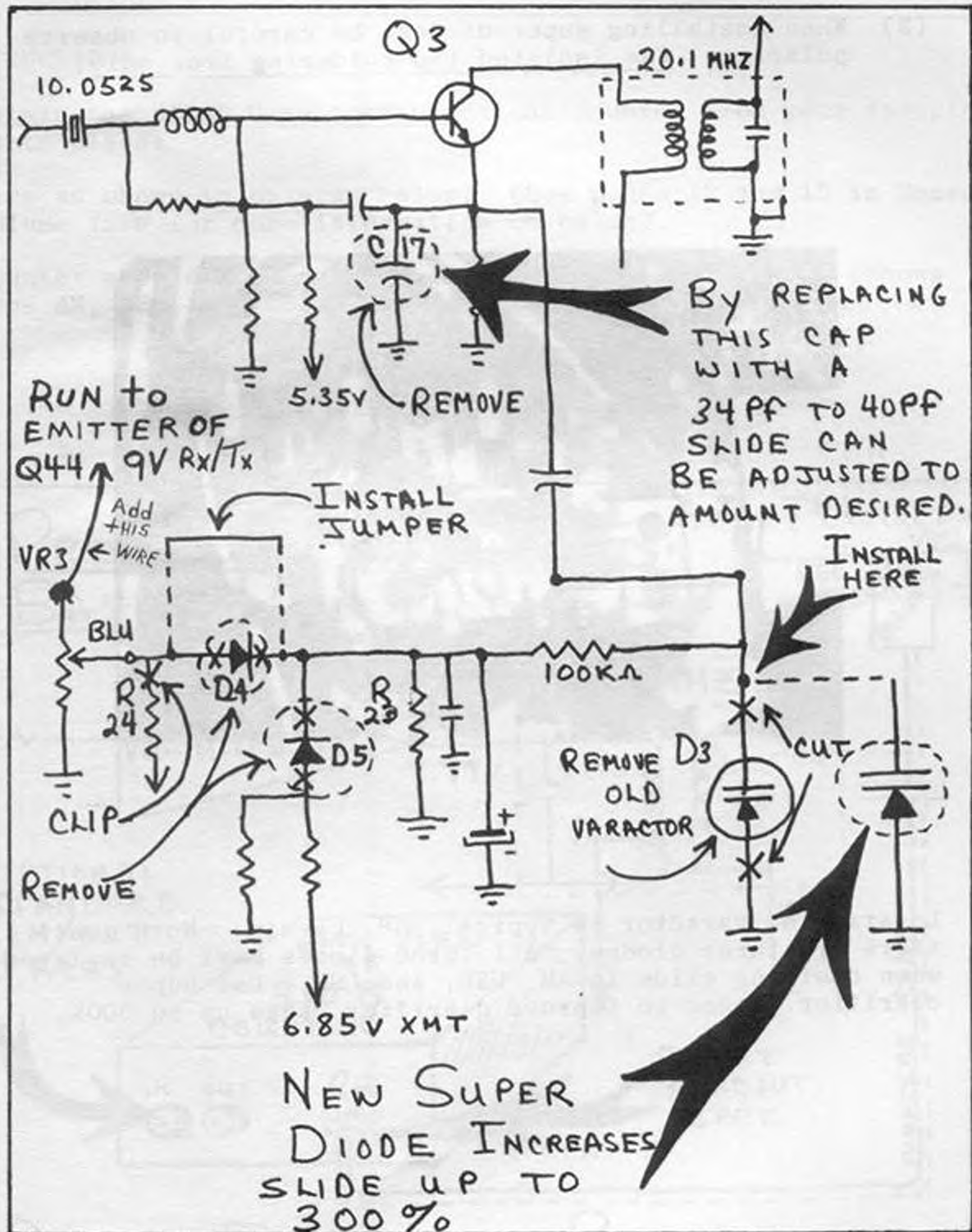

X - DENOTES CUTS

NOTE: Shows increased range with super diode.

SUPER CLARIFIER
HELPFUL HINTS

- (1) Note that parallel capacitors are pulled out when installing super diodes. (See locations A, B, and C).
- (2) When installing super diodes, be careful to observe polarity. Use isolated tip soldering iron only!

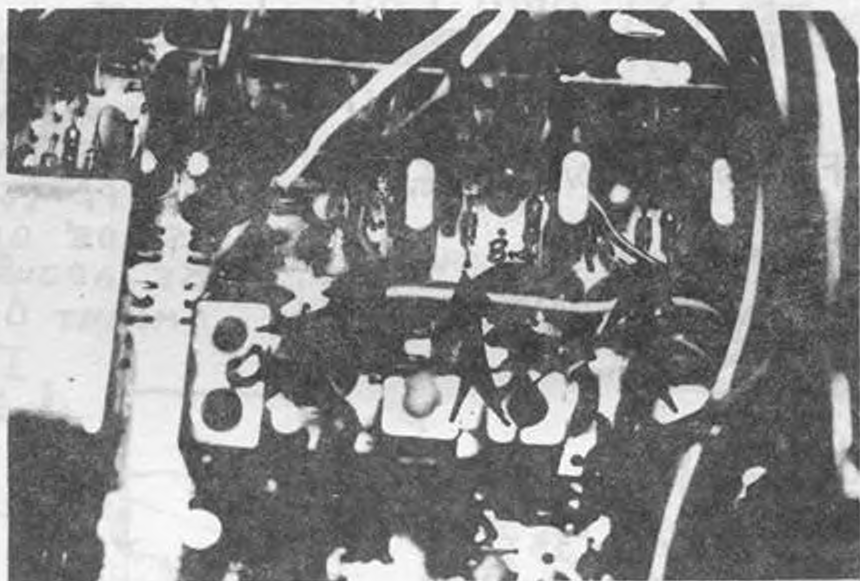

Location of varactor in typical 858 chassis. Note that there are three diodes. All three diodes must be replaced when desiring slide in AM, USB, and LSB. Use super clarifier diodes to improve clarifier range up to 300%.

MAKING THE PRESIDENT WASHINGTON BASE WITH 8719 CHIP READOUT FREQUENCY DIRECT EVEN IN RECEIVE MODE

INSTRUCTIONS:

- 1-Obtain the 310-B Glen communications counter from your favorite parts place.
- 2-Wire as shown in diagram below. (See pages 12 and 13 in Secret CB volume five for more information on balun).
- 3-Counter should readout in receive and transmit mode. (Shows true AM, LSB, and USB offset).

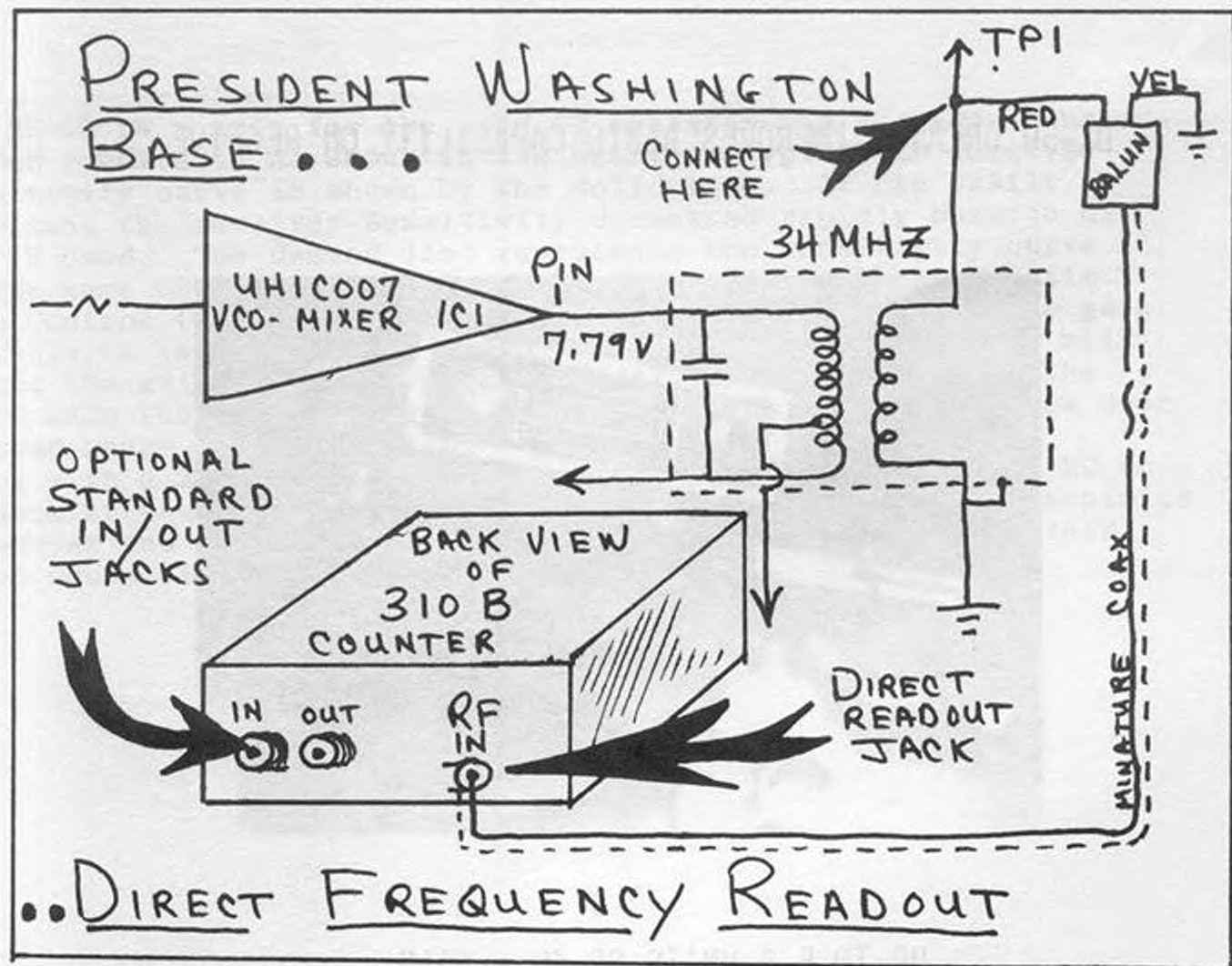

DX-50 SIGNAL MASTER



DX-50 GREATLY IMPROVES RADIO CAPABILITY ON RECEIVE



UP TO 5 S UNITS OR 30DB GAIN

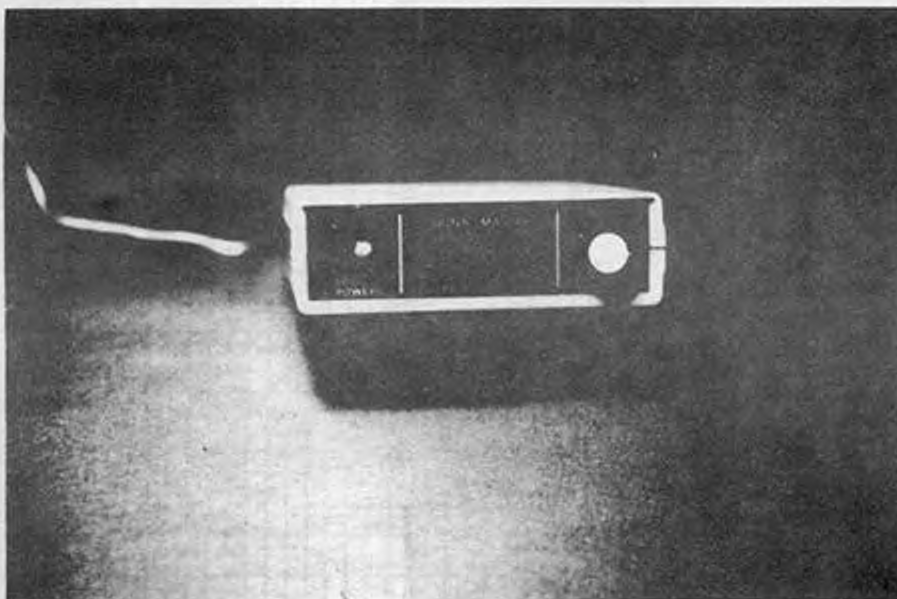

The DX-50 is a must for the avid CB operator who requires a broad-banded receiver. As shown in the chart, a typical CB receiver sensitivity curve is shown by the solid line. It can easily be seen that the receiver sensitivity decreases rapidly outside of the CB band. The dashed line represents the sensitivity curve of the same CB receiver with the DX-50 in line. The Automatic Gain Control (AGC) circuit in the radio tends to average the gain and this is the reason the curve flattens. The AGC circuit will reduce the gain on weaker signals. All things considered, the DX-50 adds the necessary gain to enhance receiver performance over a broad range of frequencies. Along with a 28 db minimum gain factor, the DX-50 carries a 20 db minimum attenuation factor. The attenuator can be used to minimize bleedover and reduce the signal strength of nearby transmitters which would otherwise overdrive the receiver.

DX-50 PERFORMANCE CHARACTERISTICS

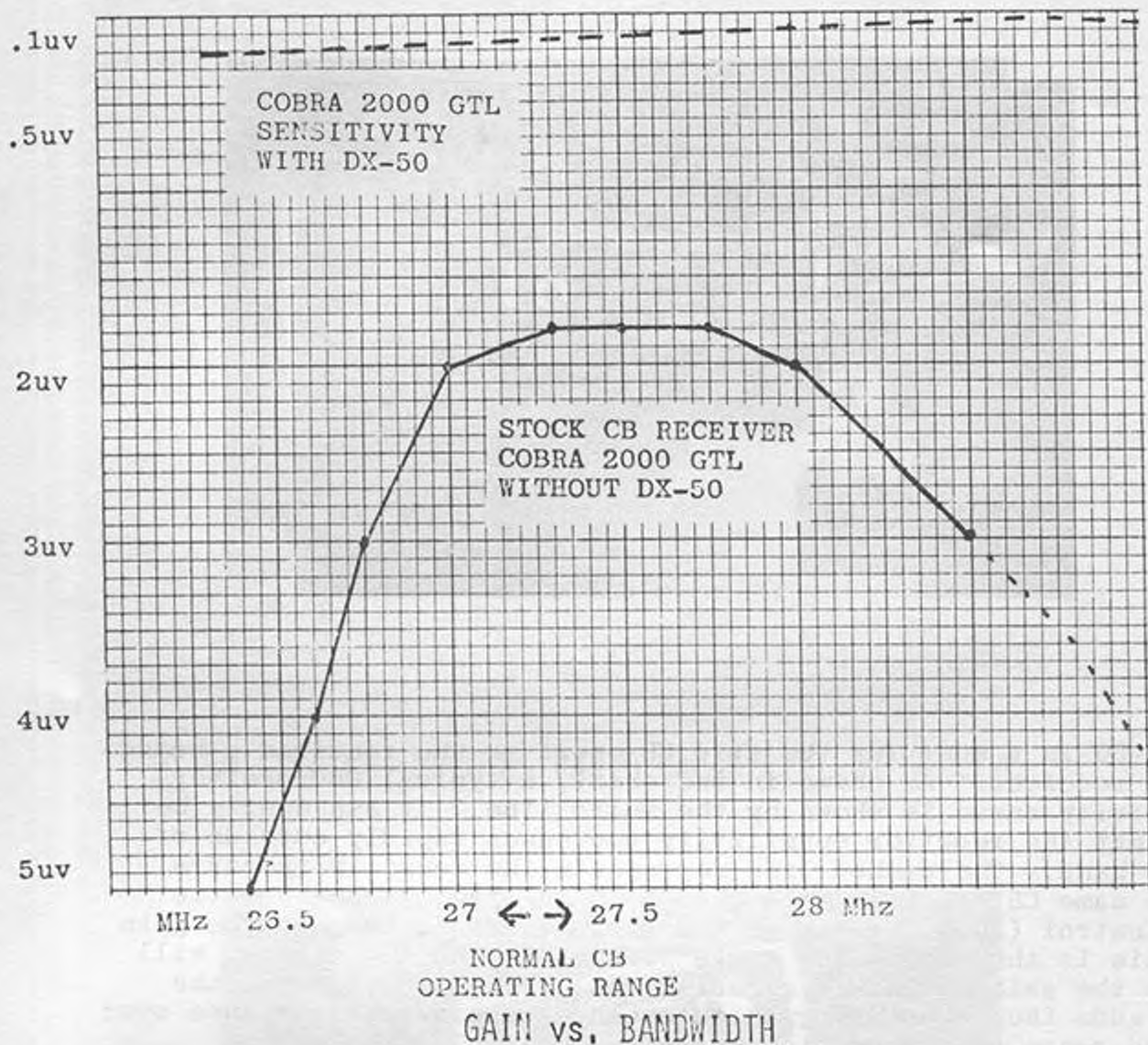

EQUIPMENT USED

Generator: Hewlett Packard 608F
 Receiver: Expanded Cobra 2000 GTL 8200 Series
 Pre-Amp: DX-50, Serial No. 001

TEST CONDITIONS:

RF Gain: Maximum
 Mode: AM
 Modulation: 30% @400Hz

SEE YOUR LOCAL CB DEALER OR ORDER DIRECT



Volume I



Volume II



Volume III



Volume IV



Volume V



Volume VI



Volume VII



Volume VIII



Volume IX



Volume X

SECRET CB ORDER FORM

SELMAN ENTERPRISES, INC.
P. O. Box 8189
Corpus Christi, Texas 78412
Phone 512 992-1303

- | | |
|--|--|
| <input type="checkbox"/> \$15.95 Vol. I | <input type="checkbox"/> \$15.95 Vol. VI |
| <input type="checkbox"/> \$15.95 Vol. II | <input type="checkbox"/> \$15.95 Vol. VII |
| <input type="checkbox"/> \$15.95 Vol. III | <input type="checkbox"/> \$15.95 Vol. VIII |
| <input type="checkbox"/> \$15.95 Vol. IV | <input type="checkbox"/> \$15.95 Vol. IX |
| <input type="checkbox"/> \$15.95 Vol. V | <input type="checkbox"/> \$15.95 Vol. X |
| <input type="checkbox"/> \$19.95 Secrets of Satellite TV | |

SHIP TO:

Name _____

Address _____

City _____ State _____ Zip _____

Ship Via: UPS First Class Parcel post Other _____

Send Check, M.O. or C.O.D. only. Add \$1.00 per book for shipping. Visa, Master Charge accepted. Add 3% for handling.