

SECRET CBTM

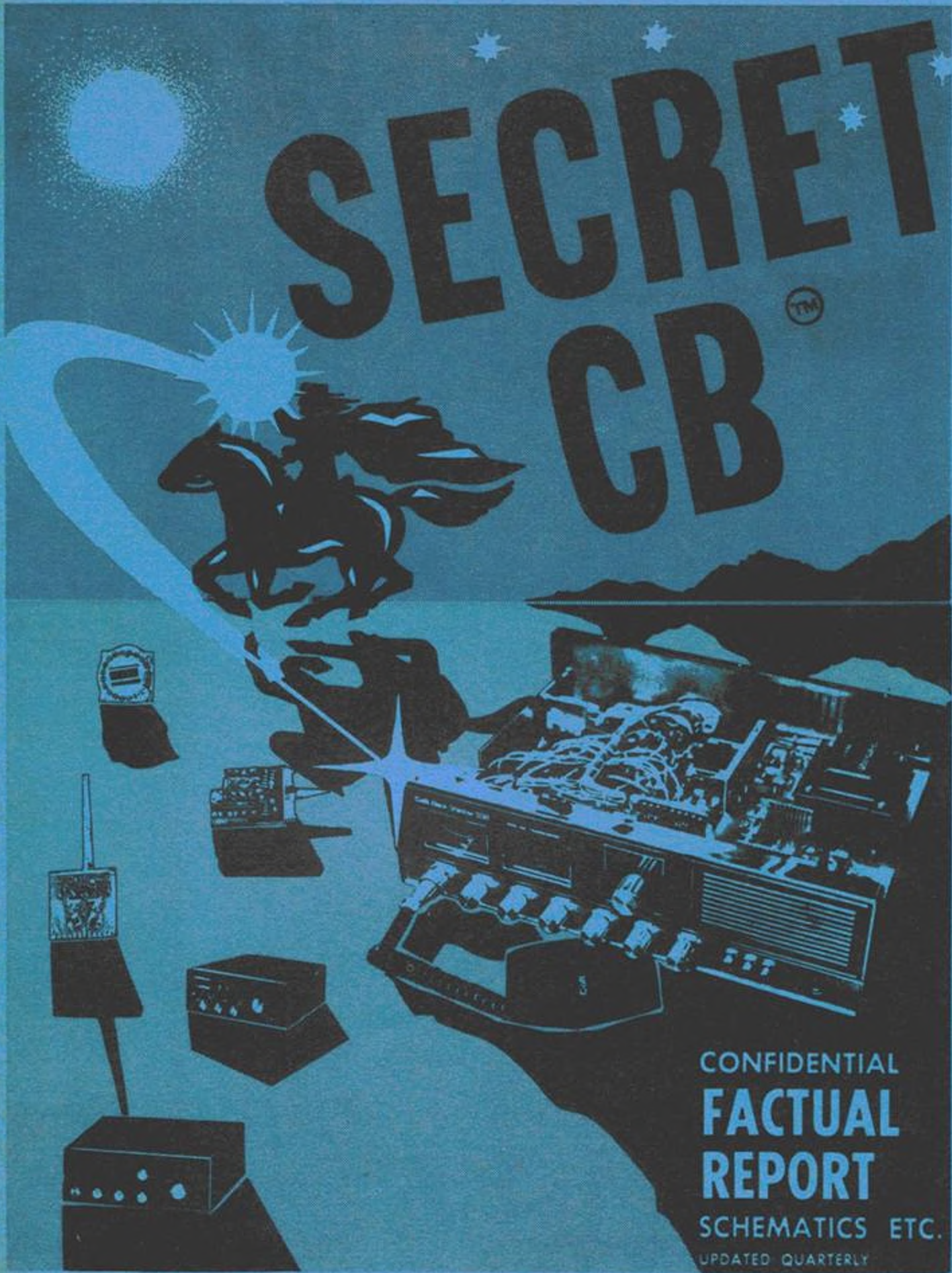

CONFIDENTIAL
**FACTUAL
REPORT**
SCHEMATICS ETC.
UPDATED QUARTERLY

NEW PRODUCT RELEASE



Colt 485 Black Shadow

.Ride with a winner

The Finest Mobile AM/SSB Period. State-of-the-art engineering for the biggest "talk-punch" in mobile CB. Colt's exclusive crystal filter reduces channel bleedover.

LED Digital Channel Readout • Squelch Control • Built-in Automatic Noise Limiter • RF Noise Blanker • Variable RF Gain Control • Clarifier Control • S/RF Meter • External Speaker Jack • Deluxe Microphone • Public Address Control • Mounting Bracket.



SEE YOUR NEAREST
CB DEALER
OR DISTRIBUTOR
IN YOUR AREA

IMPORTANT: READ THIS FIRST

The information in this book is not to be used to exceed F. C. C. specifications, in any case, as applied to power, modulation, frequency spectrum, etc. It is illegal to do this to any CLASS D RADIO.

This book is a factual report of gathered information, and as such is intended for use on radios for EXPORT ONLY.

If you are not familiar with electronics, it is better to check for advise with your local electronics or CB center, as to restrictions, etc., concerning your radio.

More information, on other units will be forthcoming in future issues, to be published on a quarterly basis.

This book will not be found at a book store, but can be obtained through your local CB store or distributor, or by sending \$12.95 to:

Secret CB

P.O. Box 8189

Corpus Christi, Texas 78412

TABLE OF CONTENTS

INTRODUCTION	Page 3
INFORMATION ON COLT	Pages 4-13
MASTER COPY B	Page 14
MASTER COPY C	Page 15
SPECIFIC RADIO MODIFICATIONS	Pages 16-25
MIKE WIRING (How to Wire Almost Any MIC to any Tranceiver)	Pages 26-32
PLL CHANNELIZER	Pages 33-39
SPECIFIC RADIO TUNE-UPS AND MODIFICATIONS	Pages 40-60
ANTENNA SECRETS	Pages 61-63
SPECIAL SECTION ON LINEAR AMPLIFIERS SCHEMATICS, ETC.	Pages 64-75

Secret C.B.

Volume Three

Published August, 1978

Copyright 1978, All rights reserved in the United
States and most foreign countries

New issues quarterly

Address any and all inquiries
with return address to:

Selman Enterprises
P. O. Box 8189
Corpus Christi, Texas 78412

Introduction

As time progresses, so do advances in electronics. Many manufacturers have sacrificed quality for quantity leaving behind good adjacent channel rejection and other qualities that make a C.B. have a good transmitter and receiver. The "Uniden" and Cybernet chassis, which are manufactured overseas for American companies, are always an excellent choice in equipment.

Contrary to the old myth, "23 channels are more powerful than 40 channel sets," the truth of the matter is 40 channel C.B.'s have a much better receiver than 23 channels! In order to accept more channels, the 23 Channel sets were redesigned making the receiver more sensitive with less noise. Generally speaking, the 40 channel transmitters are "cleaner" and more reliable. As far as "talking power" goes, I would say that 40 Channel sets have more potential than 23 channel sets. With the right antenna, mobile or base, they give more service per dollar spent.

Adjacent channel rejection in the receiver is always a problem, and that doesn't come cheap by manufacturing standards. For instance, Colt has spent more of its manufacturing dollar on noise. Crystal lattice filters are expensive, but necessary. A good crystal lattice filter is the main quality to look for in buying any single sideband radio.

Single sideband is growing in popularity, and there is a specific reason behind this. It's certainly not the price, sidebands can be expensive. The reason is simple. It's so simple, you can turn your AM C.B. set on and hear the reason ... "sunspots" are the problem. They can cut an AM C.B. set down in reception and range, where a sideband has the uncanny ability to "cut through the hash" communicating a longer distance, even though the noise level is high. I am not taking away from AM C.B. sets. Remember, there is a difference in cost!

If the truth were known, there are certain people who would rather everyone be on sideband. Why? Because, there can be six conversations on one channel at the same time, the "bleedover" is minimal, and no linears or power mikes are needed. I say this in anticipation of feedback. Again, this is my opinion.

I have received much correspondence from C.B.'ers, engineers, and technicians from all over the United States and the world. I appreciate your letters, ideas, and helpful hints that have made "Secret C.B." a success. I do not claim to be an expert, but I will always keep it simple and tell it like it is!

73's
Rodney L. Johnson

author/publisher

95 Channel Conversion

PARTS NEEDED:

1. 2 each 3K $\frac{1}{2}$ watt resistors
2. 12" 4 conductor ribbon wire
3. 1 DPDT center off toggle switch (on-off-on, on some models a existing panel switch may be used.)
4. Power meter

STEPS

1. Remove top and bottom cover of radio.
2. Locate PLL02A, just rear of channel selector on component side of radio. Turn radio over and locate foil pattern of PLL02A on foil. See drawing of foil pattern side of radio.
3. Make necessary foil cuts on foil side of P.C. board. (Follow blow up of PLL02A mounting for foil cuts, resistor and wire connections.)
4. Bridge foil cuts with 3K resistors.
5. Connect properly coded ribbon wire to foil cuts.
6. Wire switch per schematic.
7. Mount switch at any convenient location.
8. Some tuning may be necessary to broad band radio. Adjust L1, L2 for even power on low of 26.755 and high of 27.705.
9. Adjust RV-2 for 100% modulation.
10. Follow normal peaking procedures for maximum power output using L7, L11, and L12.

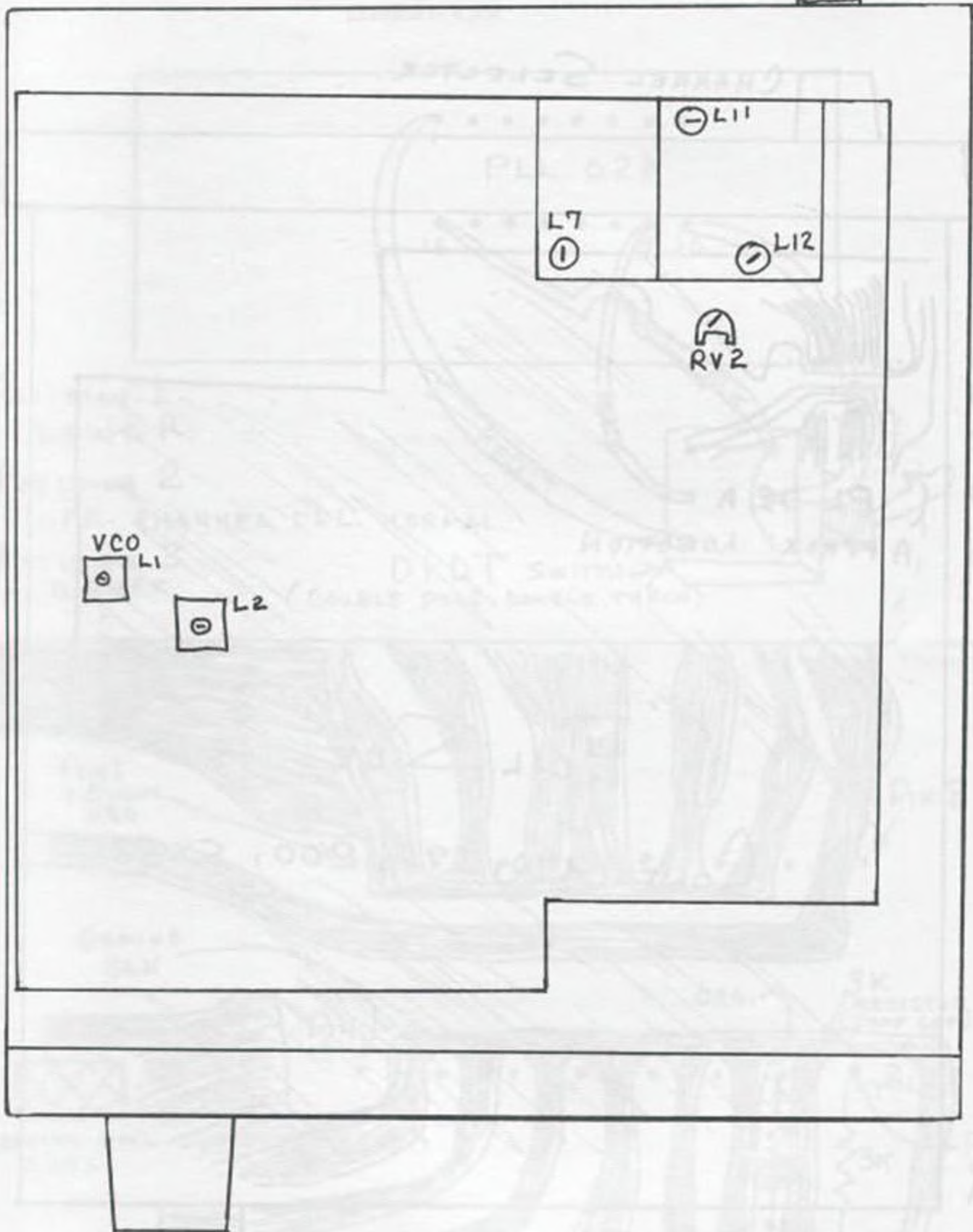

CHANNEL SELECTOR.



PL 02 A
APPROX. LOCATION

FOIL SIDE

COKT 290, 390, 800, SX33

EXPANDED VIEW

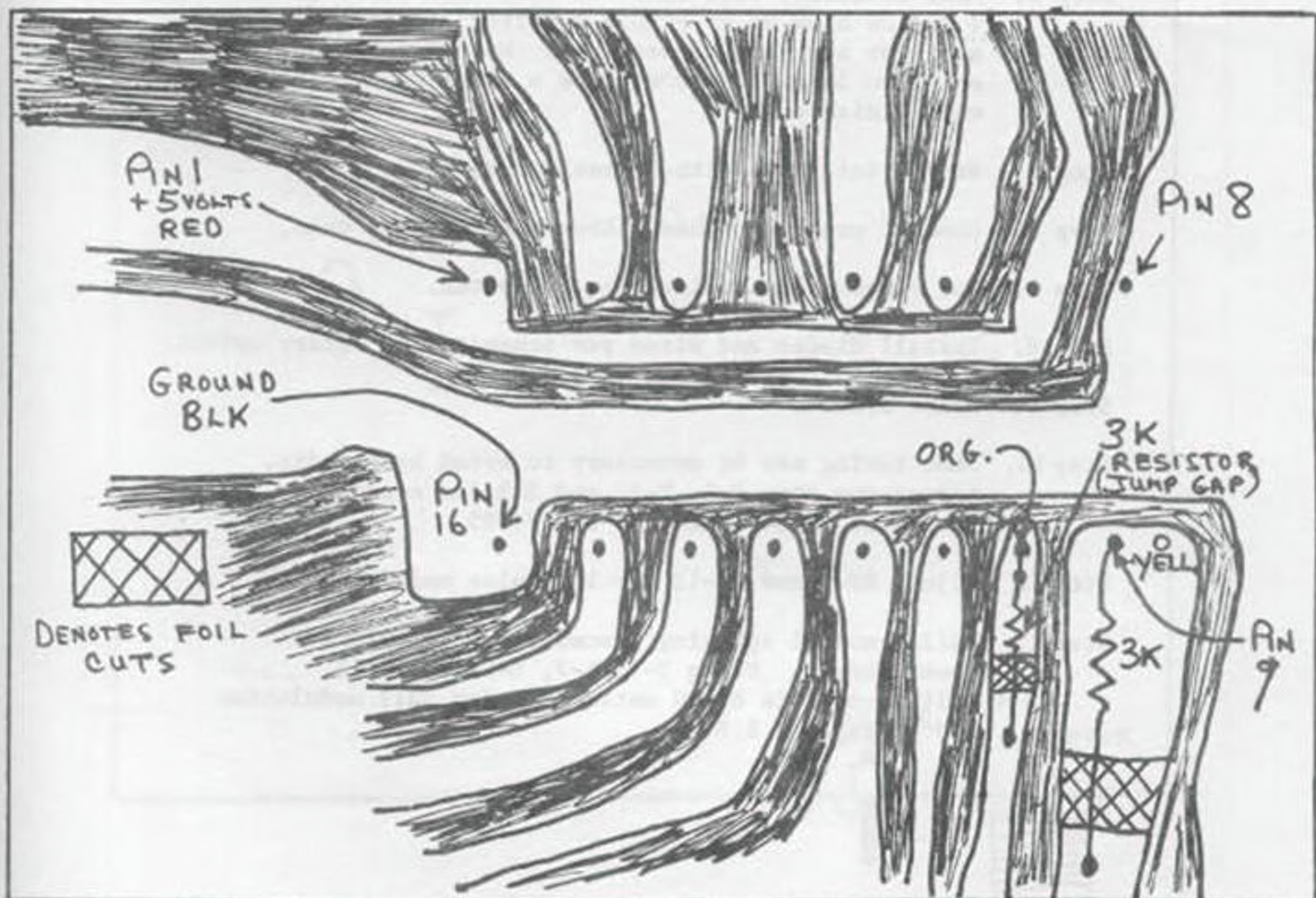
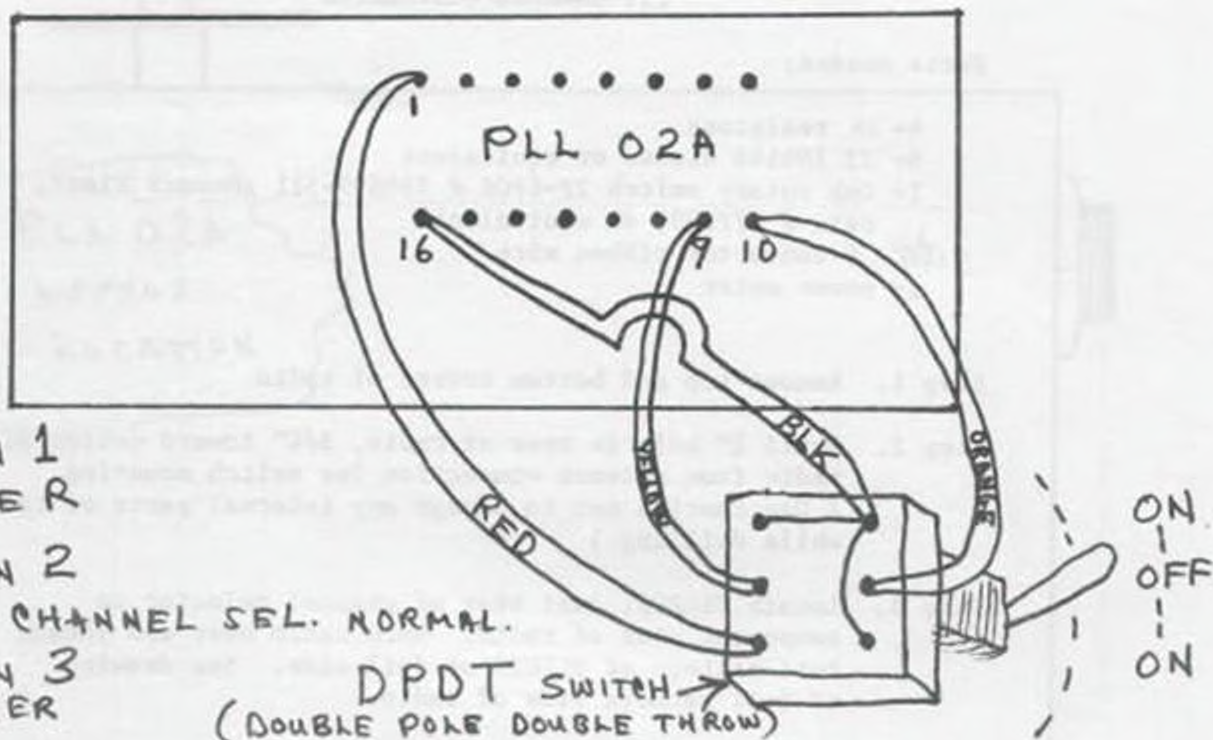

135 CHANNEL CONVERSION

Parts needed:

- 4- 1k resistors
- 8- TI 1N4148 diodes or equivalent
- 1- Oak rotary switch 2P-6POS # 399639-511 (Newark Elect. cat. # 57F889) or equivalent
- 18"- 6 conductor ribbon wire
- 1- power meter

- Step 1. Remove top and bottom covers of radio
- Step 2. Drill $\frac{1}{4}$ " hole in rear of radio, $\frac{3}{4}$ " toward center of radio from antenna connection for switch mounting. (Use caution not to damage any internal parts of radio while drilling.)
- Step 3. Locate PLL02A, just rear of channel selector on component side of radio. Turn radio over and locate foil pattern of PLL02A on foil side. See drawing of foil pattern side of radio.
- Step 4. Make necessary foil cuts on foil side of PC board. (Follow blow up of PLL02A mounting, for foil cuts, resistor and wire connections. Note 2 foil cuts on brown lead. There will be a total of 5 foil cuts when finished.)
- Step 5. Bridge foil cuts with 1K resistors.
- Step 6. Connect properly coded ribbon wire to foil cuts.
- Step 7. Run ribbon wire to location of switch.
- Step 8. Install diodes and wires per schematic on rotary switch.
- Step 9. Mount switch.
- Step 10. Some tuning may be necessary to broad band radio. Adjust the VCO, T-1, T-2, and T-3 for even power on low of 26,645 and high of 27,995.
- Step 11. Adjust RV-2 and RV-12 for 100% plus modulation.
- Step 12. Follow normal speaking procedures for maximum power output. Using T-6, L-7, L-11 and L-13. Unit is capable of 10 watts AM under full modulation and 18 watts S.S.B.

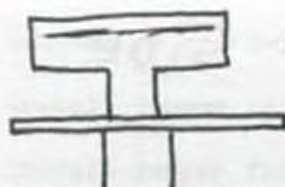

CHANNEL NO.
SELECTOR.

PLL 02A
APPROX.
LOCATION

Mic.

Foil Side
COLT 480+485
SSB

2P6 POS
SWITCH

ANT.
CONNECTOR

<u>Freq.</u>	<u>Switch Position</u>	<u>Channel</u>	<u>Freq.</u>	<u>Switch Position</u>	<u>Channel</u>
27.165	2	17	27.875	4	24
27.175	2	18	27.885	4	25
27.185	2	19	27.895	4	23
27.195	Miss		27.905	4	26
27.205	2	20	27.915	4	27
27.215	2	21	27.925	5	28
27.805	4	17	27.935	5	29
27.815	4	18	27.945	5	30
27.825	4	19	27.955	5	31
27.835	Miss		27.965	5	32
27.845	4	20	27.975	5	33
27.855	4	21	27.985	5	34
27.865	4	22	27.995	5	35

In position #6 channel

selector is in normal

mode.

DIODE & WIRE PLACEMENT

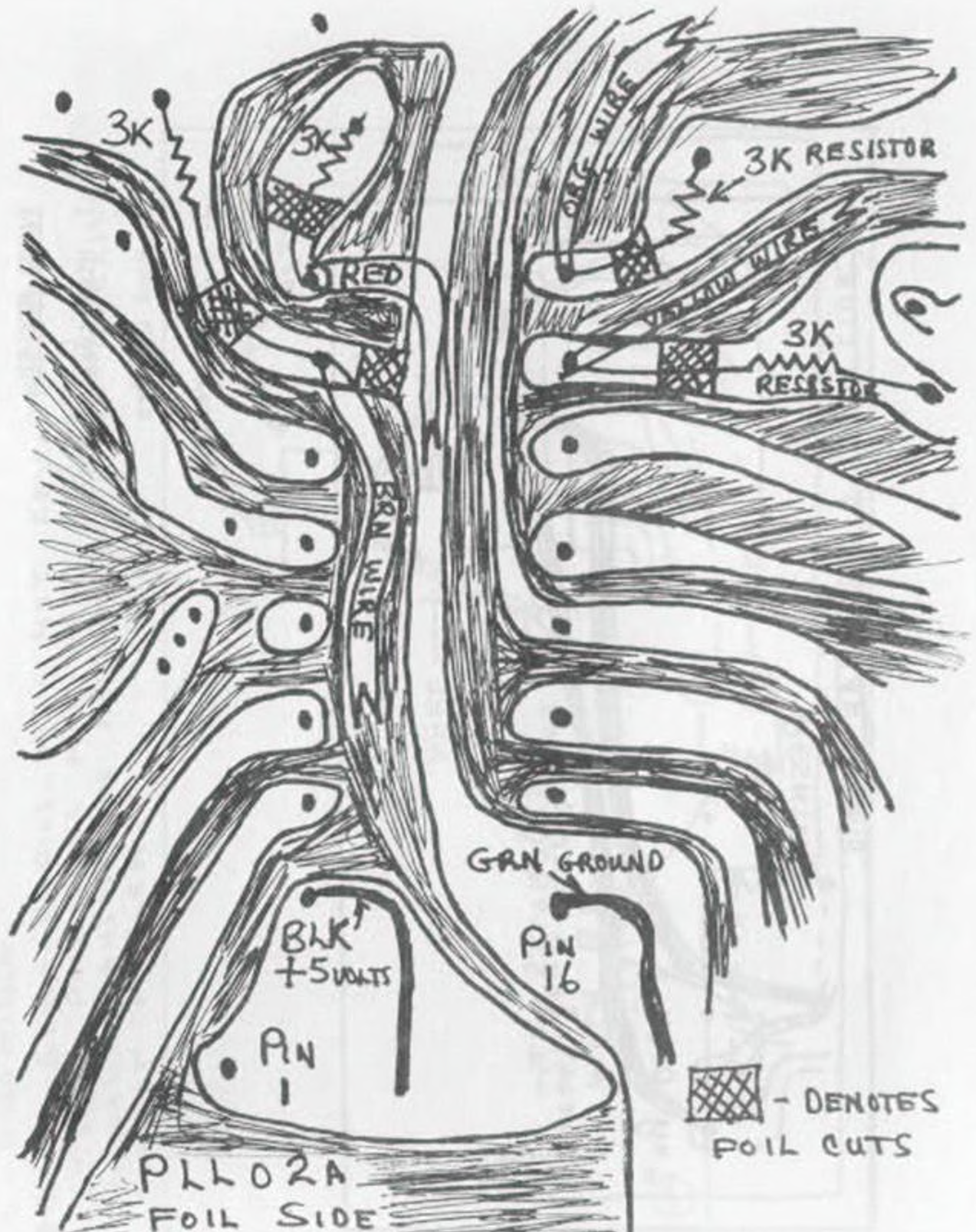
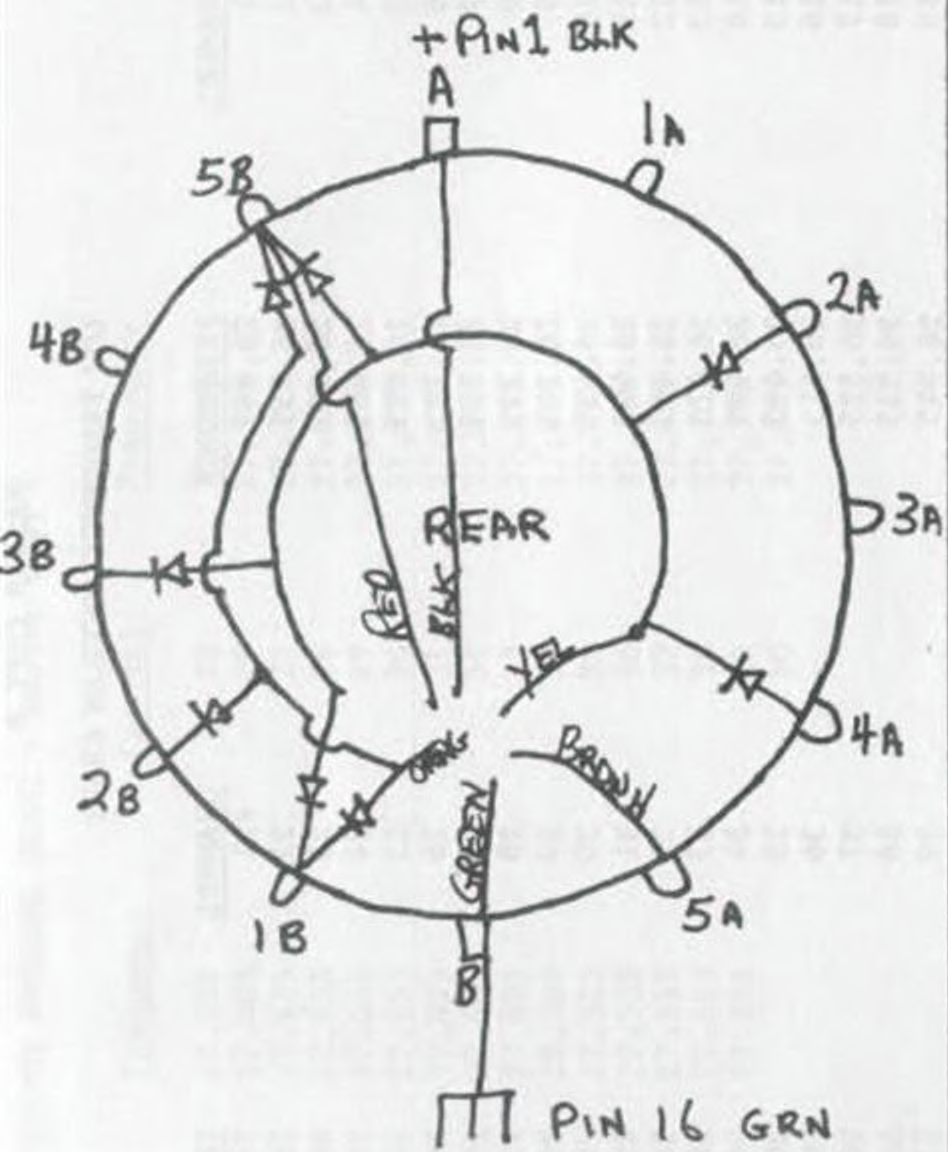

PLLO2A
FOIL SIDE

NOTE
2 FOIL CUTS
ON BRN LEAD

LOW FREQUENCY PROGRAM CHART

<u>CHANNEL</u>	<u>FREQUENCY</u>	<u>CHANNEL</u>	<u>FREQUENCY</u>
#1	26.645	#21	26.575
2	26.655	22	26.585
3	26.665	23	26.615
4	26.685	24	26.595
5	26.695	25	26.605
6	26.705	26	26.625
7	26.715	27	26.635
8	26.735	28	26.645
9	26.745	29	26.655
10	26.435	30	26.665
11	26.445	31	26.675
12	26.465	32	26.685
13	26.475	33	26.695
14	26.485	34	26.705
15	26.495	35	26.715
16	26.515	36	26.725
17	26.525	37	26.735
18	26.535	38	26.745
19	26.545	39	27.395
20	26.565	40	27.405

PARTS NEEDED

1. Mini toggle switch
2. Hook up wire
3. A 3k ohm resistor

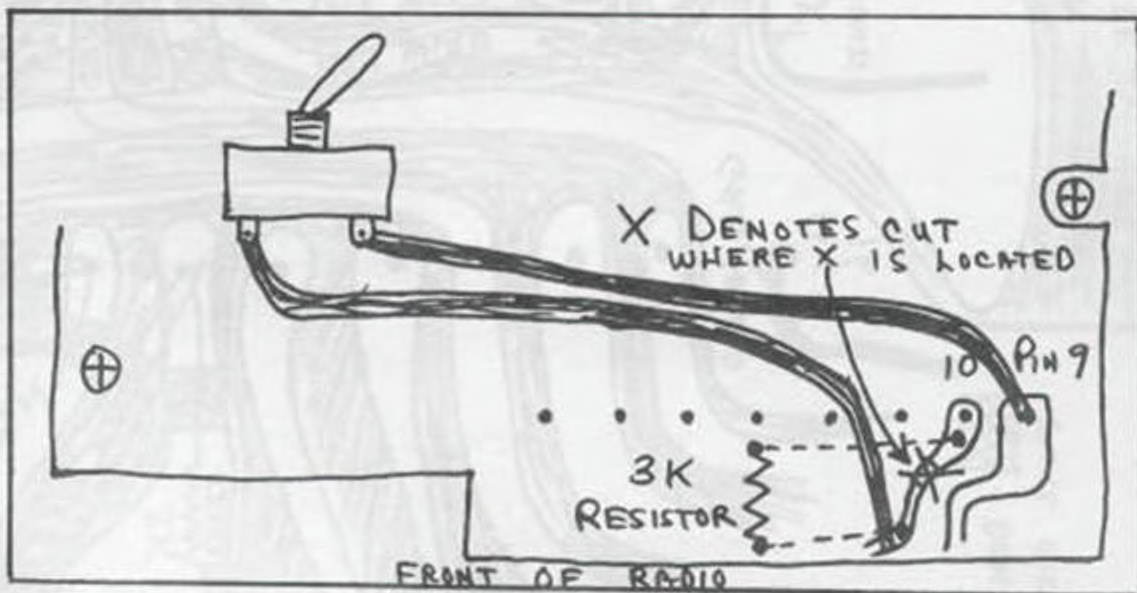

Channel	Frequency	Channel	Frequency
# 10	27.395	# 25	27.565
11	27.405	26	27.585
12	27.425	27	27.595
13	27.435	28	27.605 *
14	27.445	29	27.615
15	27.455	30	27.625
16	27.475	31	27.635
17	27.485	32	27.645
18	27.495	33	27.655
19	27.505	34	27.665
20	27.525	35	27.675
21	27.535	36	27.685
22	27.545	37	27.695
23	27.575	38	27.705
24	27.555	39	27.395
		40	27.405

Parts Needed

1. Mini toggle switch
2. Hook up wire
3. A 3k ohm resistor

* NOTE: SOME RADIOS MAY NOT KEY UP OVER 27.605. PWR LOSS MAY ALSO BE NOTED. NORMAL TRANSMITTER ALIGNMENT WILL USUALLY CORRECT PROBLEM.

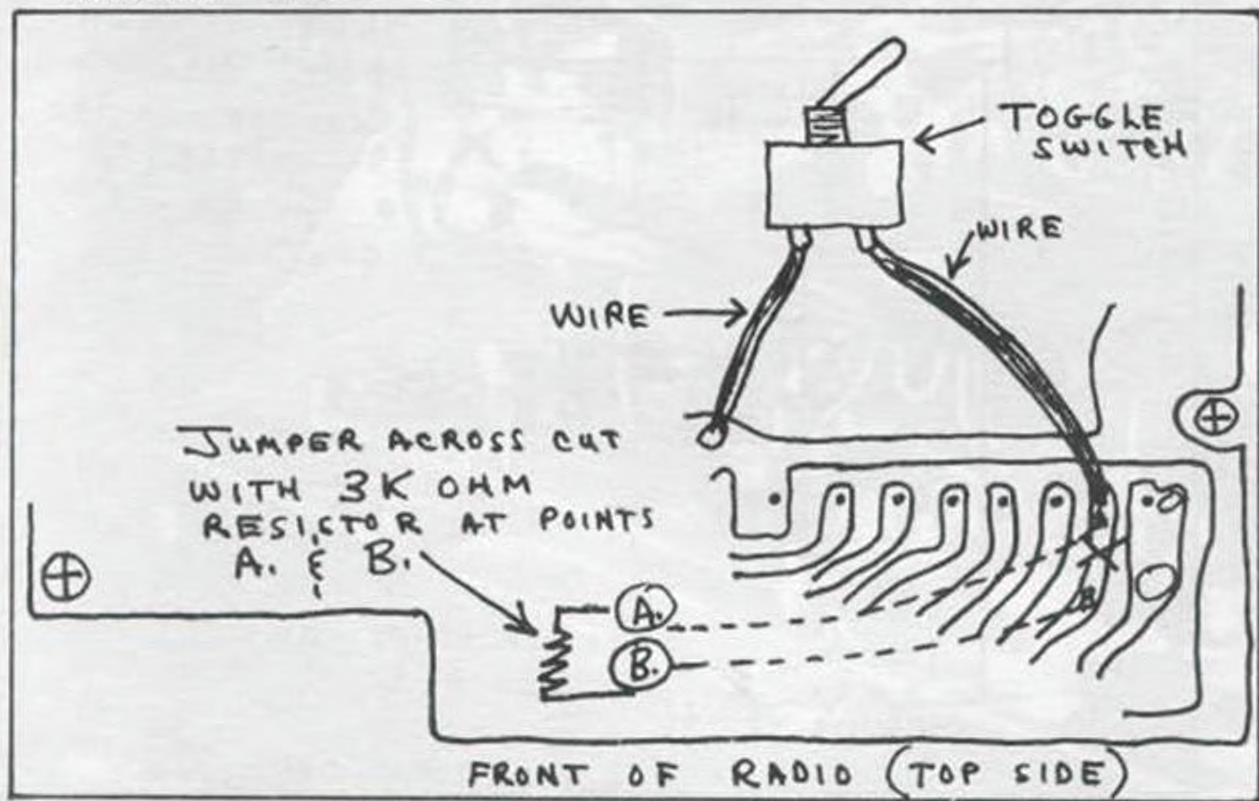

SUPER MOD. IV. (FREQ. COUNTER KIT FITS P. MADISON BASE)

INSTRUCTIONS:

1. REMOVE COVERS ON RADIO
2. REMOVE FRONT COVER PLATE
(BE CAREFUL, THERE IS A SCREW LOCATED IN CENTER OF PLATE INSIDE.)
3. REMOVE CLOCK (TERMINATE WIRES)
4. OBTAIN $\frac{1}{8}$ " SMOKED PLEXI-GLASS PLATE
CUT $1\frac{13}{16}$ " WIDE BY $5\frac{3}{4}$ " LONG. CUT HOLES FOR FREQ COUNTER MODULE.
5. INSTALL COUNTER. HOOK UP 2000 μ F 25VOLT CAP AND INSTALL 15 OHM RESISTOR (1WATT) AS PER DRAWING.
6. FREQ. COUNTER MODULE HAS A MEMORY SWITCH AND IS MADE BY TEKNIK MODEL FC-106.
7. CONTACT SECRET CB FOR MORE INFO IF NEEDED.

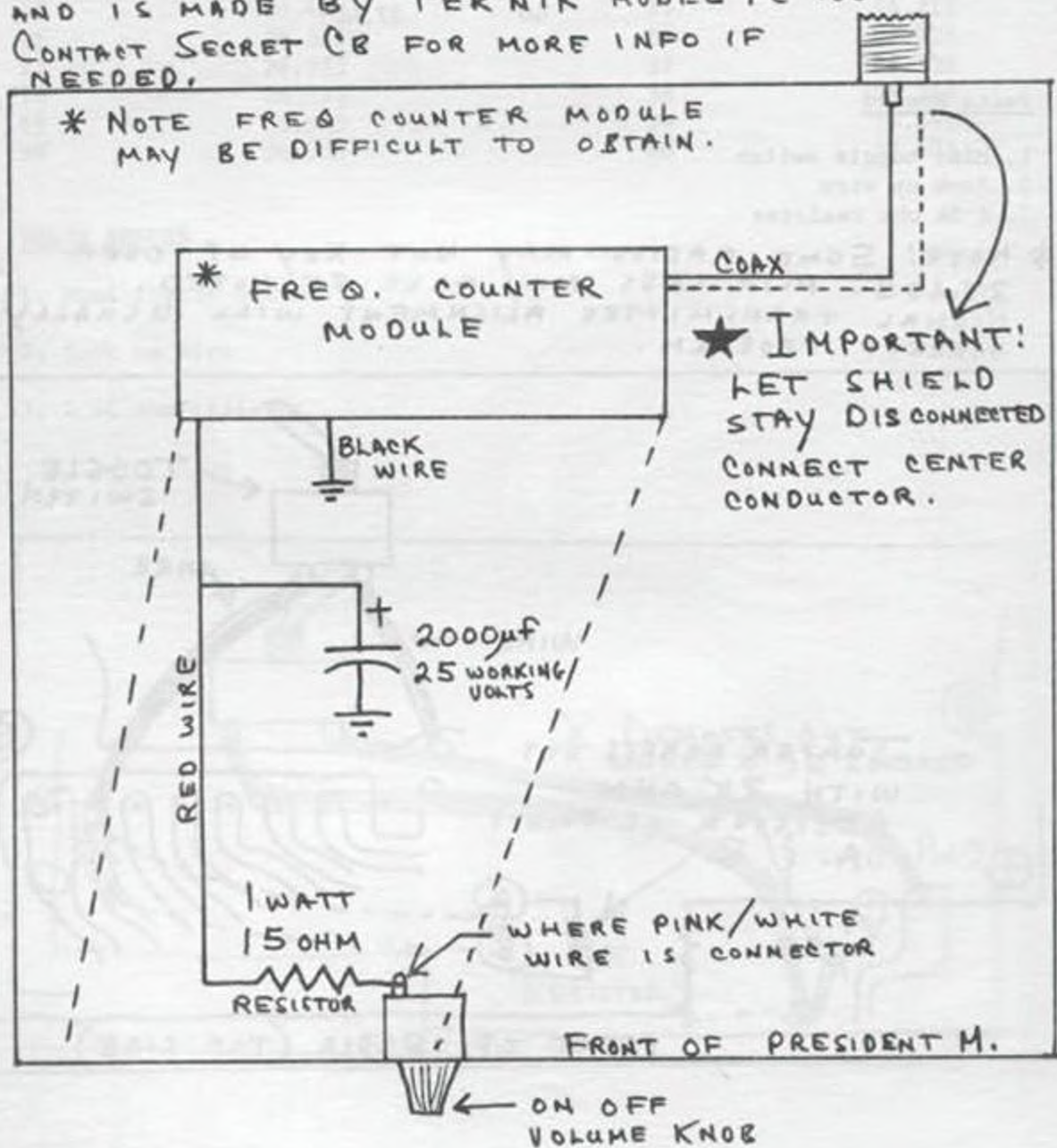

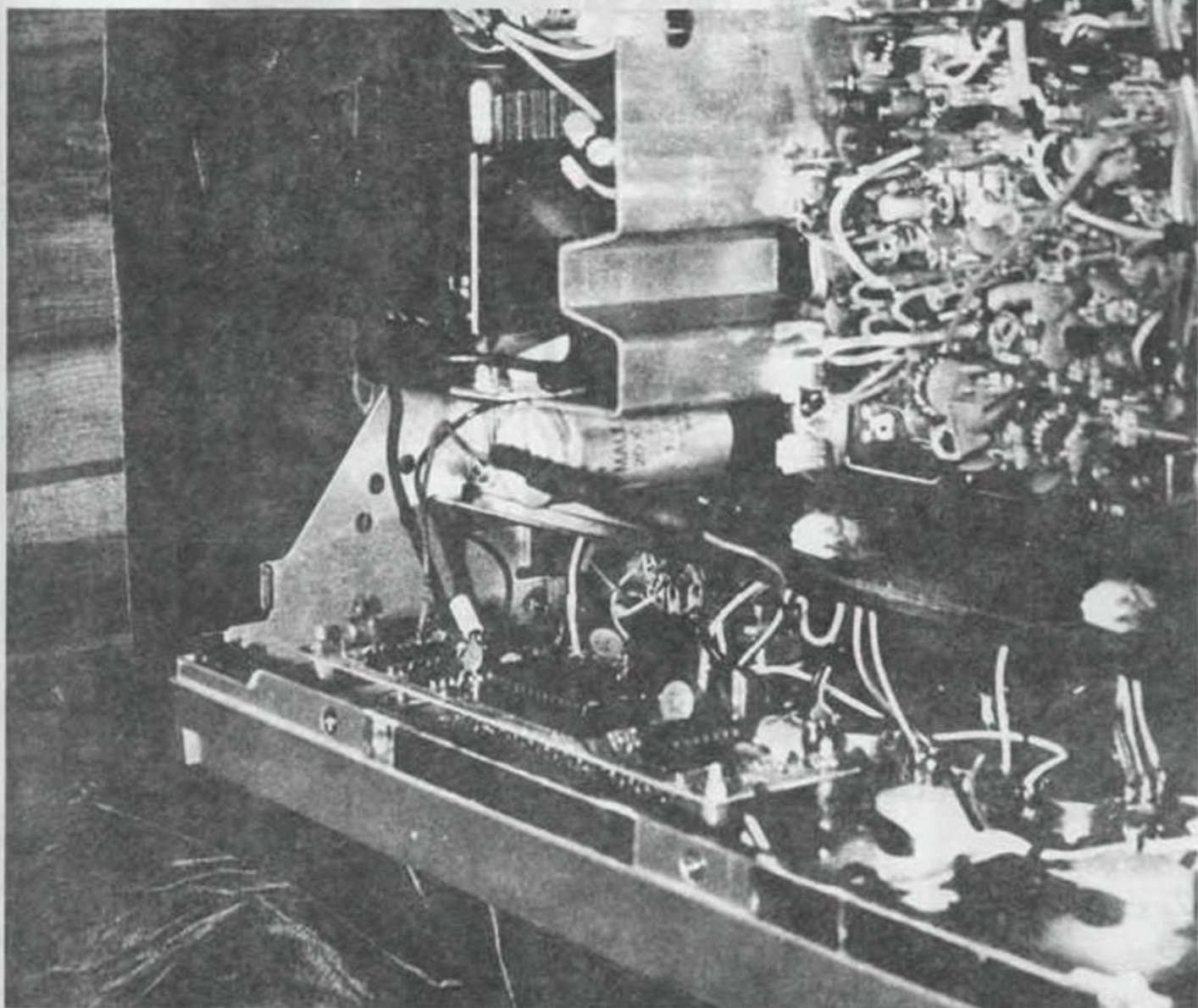
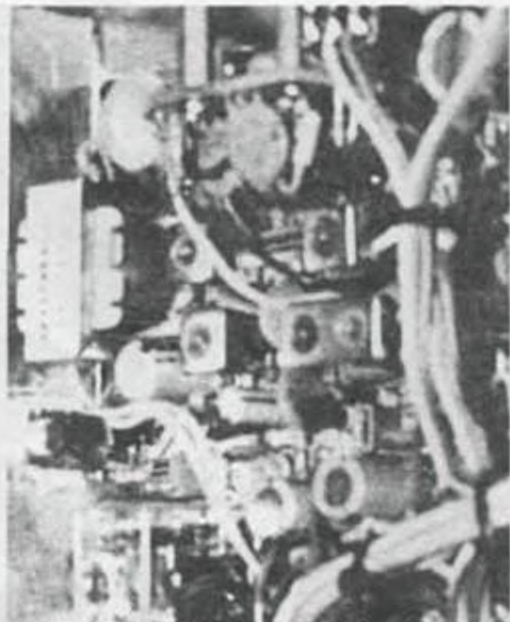
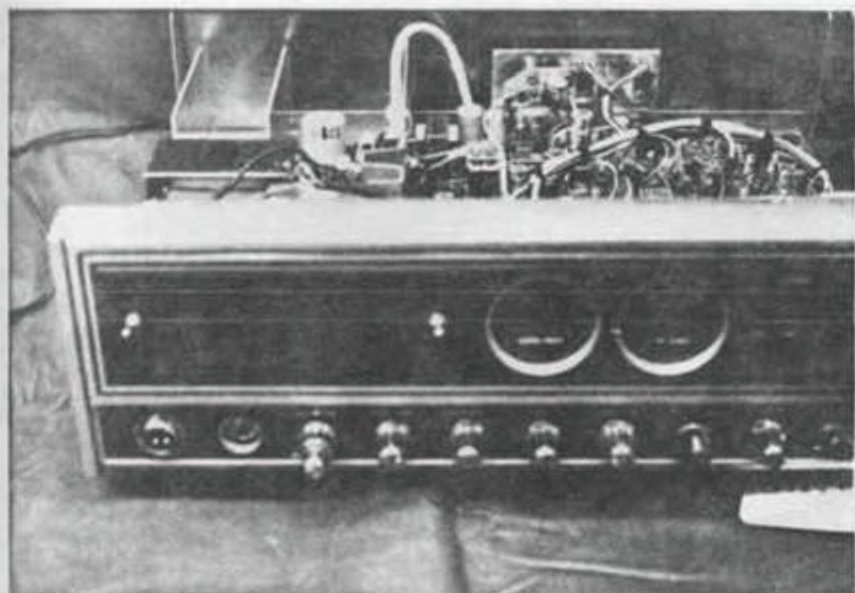

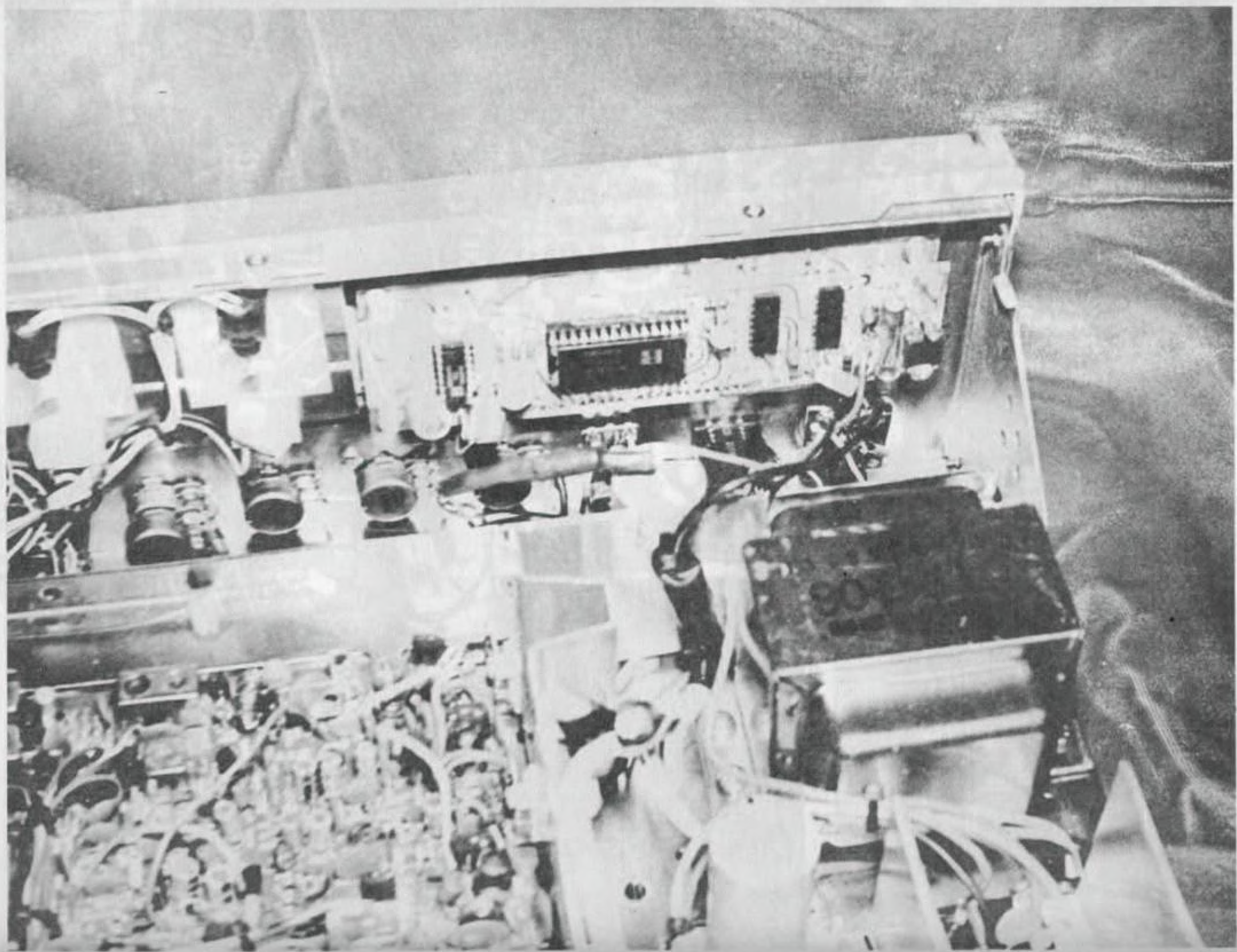

COBRA 140 GTL

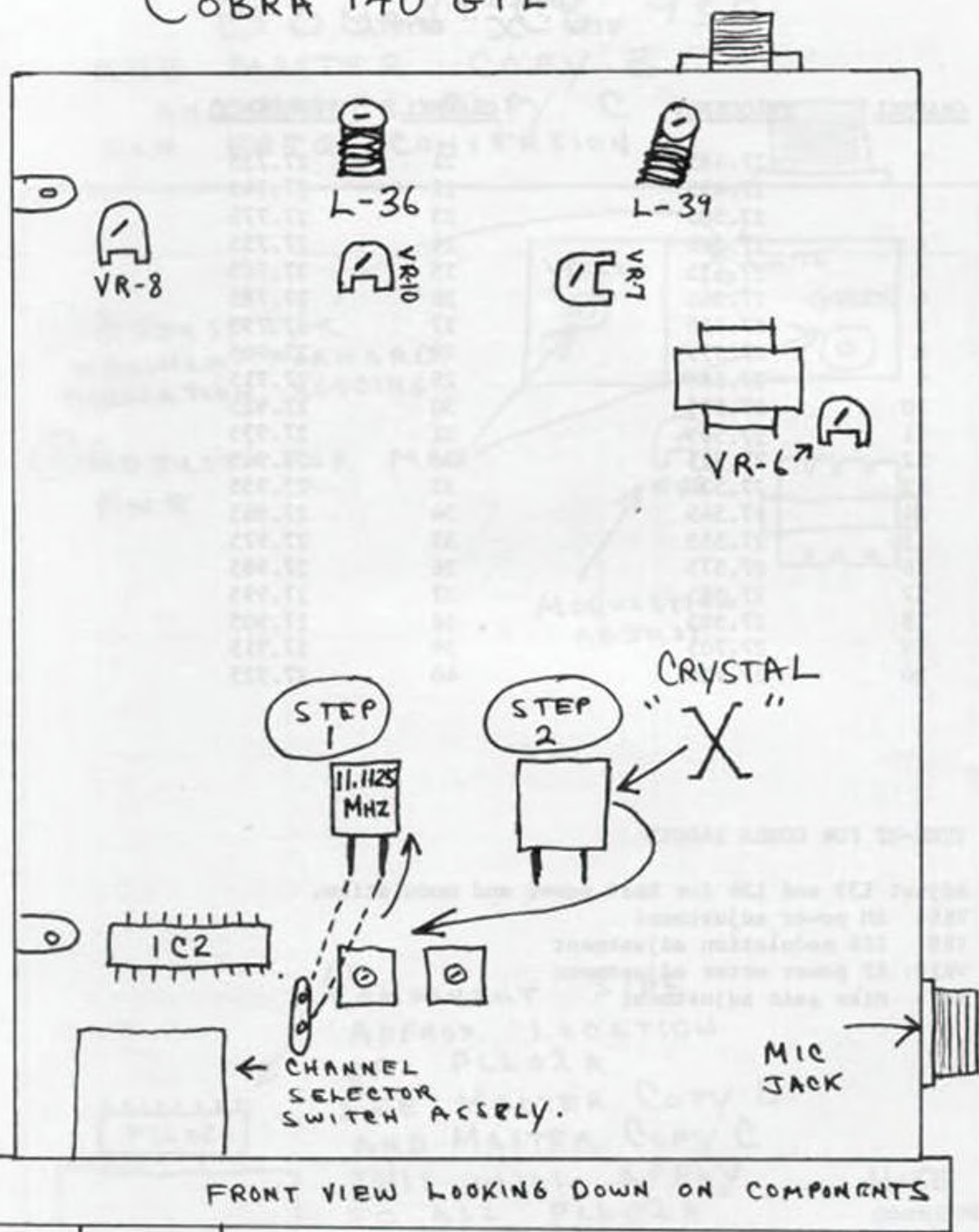

***WARNING: Do NOT USE**

THIS MODIFICATION IN THE U.S. (FOR EXPORT ONLY)

STEPS:

1. REMOVE 11.1125 CRYSTAL
2. INSTALL OR USE CRYSTAL SWITCH "X" CRYSTAL.
3. NOTE: SEE FREQ. CHART.
4. CRYSTAL "X" IS AN EXPERIMENTAL CRYSTAL AVAILABLE AT SOME DISTR. AND CB SHOPS.

HIGH FREQUENCY CHART
COBRA 140GTL
WITH "X" CRYSTAL

<u>CHANNEL</u>	<u>FREQUENCY</u>	<u>CHANNEL</u>	<u>FREQUENCY</u>
1	27.485	21	27.735
2	27.495	22	27.745
3	27.505	23	27.775
4	27.525	24	27.755
5	27.535	25	27.765
6	27.545	26	27.785
7	27.555	27	27.795
8	27.575	28	27.905
9	27.585	29	27.915
10	27.595	30	27.925
11	27.505	31	27.935
12	27.525	32	27.945
13	27.535	33	27.955
14	27.545	34	27.965
15	27.555	35	27.975
16	27.575	36	27.985
17	27.585	37	27.995
18	27.595	38	27.905
19	27.705	39	27.915
20	27.725	40	27.925

TUNE-UP FOR COBRA 140GTL

Adjust L39 and L36 for best power and modulation.

- VR6: AM power adjustment
- VR8: SSB modulation adjustment
- VR10: RF power meter adjustment
- VR7: Mike gain adjustment

BOMAN CB 930

SEE MASTER COPY B
AND MASTER COPY C
FOR FREQ CONVERSION

① ADJUST FOR
MAXIMUM FORWARD
MODULATION LOADING.

② ADJUST FOR MAX
PWR

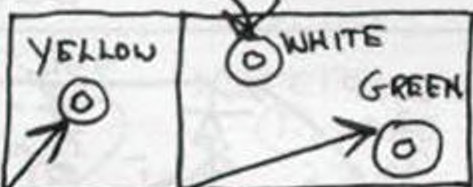

MODULATION
ADJUST

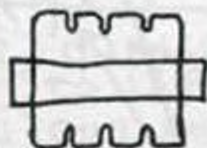

COMPONENT SIDE
APPROX. LOCATION
OF PLL02A
SEE MASTER COPY B
AND MASTER COPY C
THIS WILL APPLY
TO ALL PLL02A
CIRCUITS WITH
SIMILAR CHASSIS.



MIKE
CONNECTOR



BOMAN CB 930



TRAM D201

MODIFICATION FOR TRANSMIT ON MANUAL TUNER

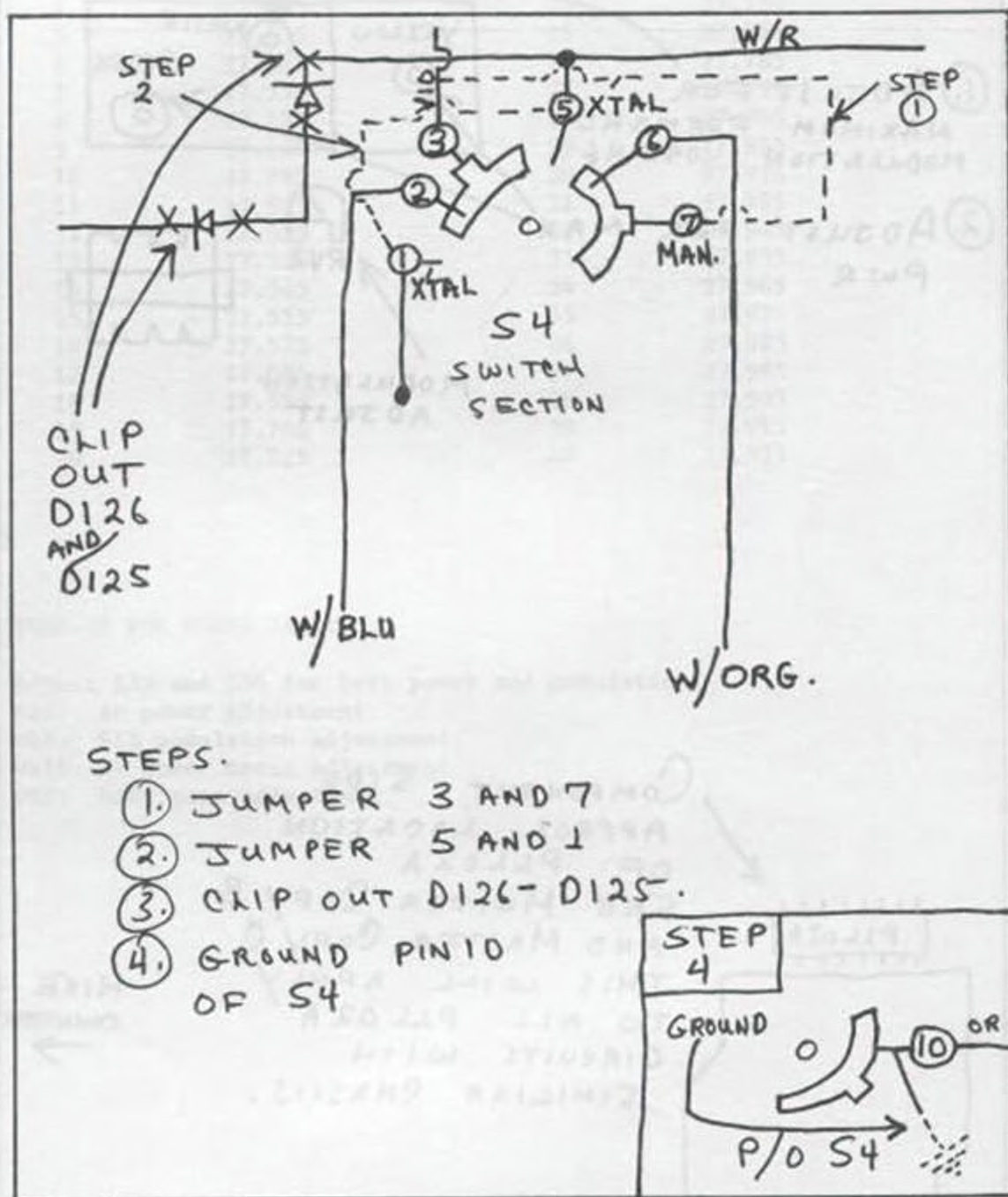

STEPS.

- ① JUMPER 3 AND 7
- ② JUMPER 5 AND 1
- ③ CLIP OUT D126 - D125.
- ④ GROUND PIN 10 OF S4

TRAM D201 MODIFICATION FOR LOW FREQ ON MANUAL TUNER.

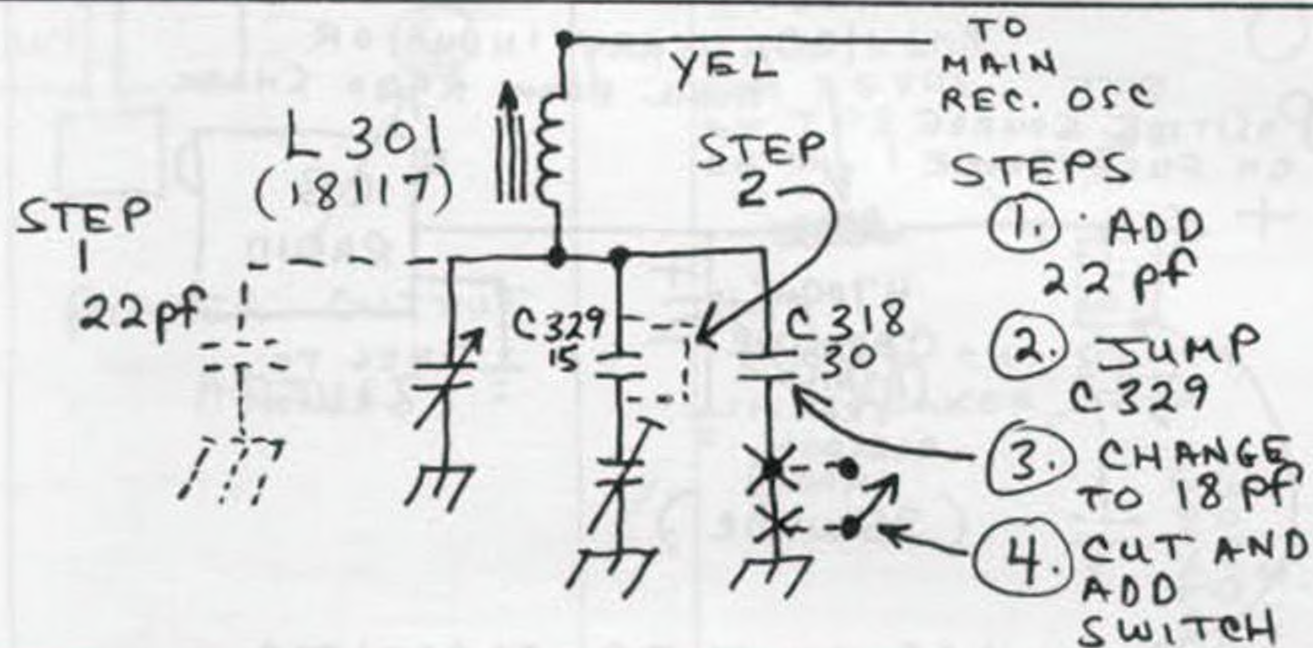

TRAM D201 3 STAGE POWER OUTPUT MODIFICATION

STEPS

1. ADD SWITCH AS PER DOTTED LINES.
2. ADD WIRES AS PER DOTTED LINES

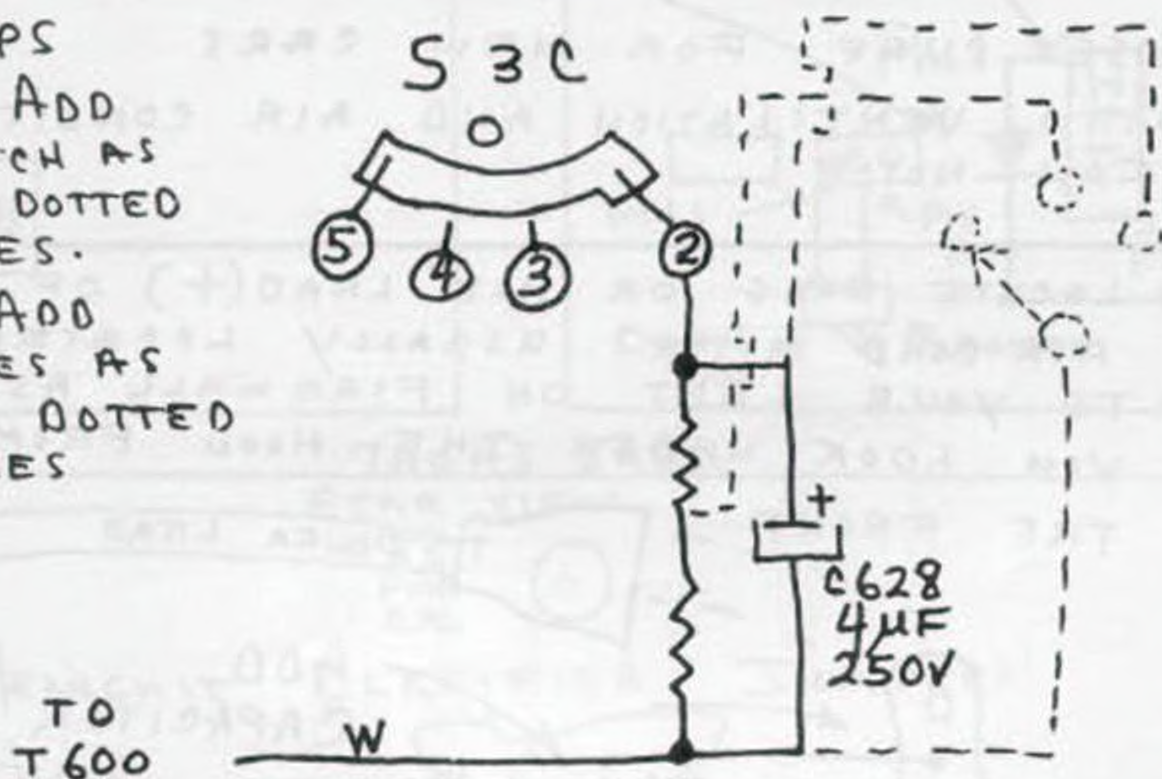

NOISE WHINE "CURE" FOR CB's

WITH ALTERNATOR NOISE

NOTE! ESPECIALLY NEEDED ON SIDEBANDS
SINCE SENSITIVITY ON RECEIVE IS GREATER.

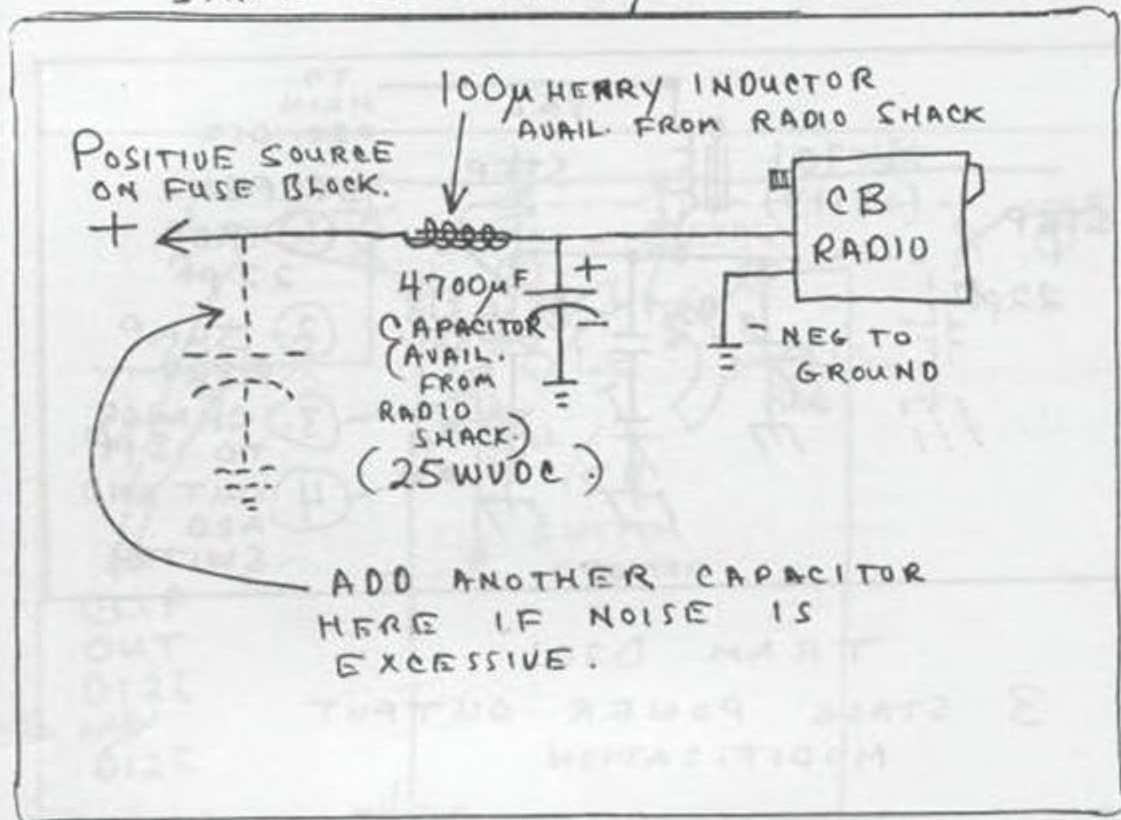

NOISE CURE FOR NEW CARS
WITH VENTILATION AND AIR CONDITIONER
FAN NOISE

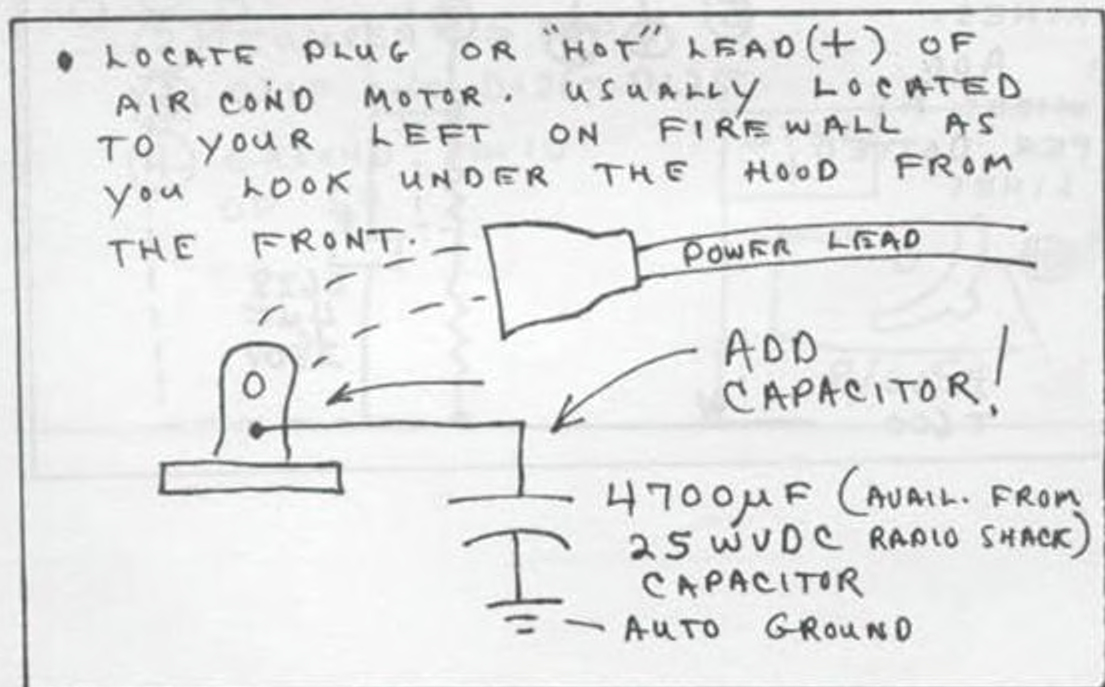

CPI 2000 MOBILE BASE
80 CHANNEL CONVERSION

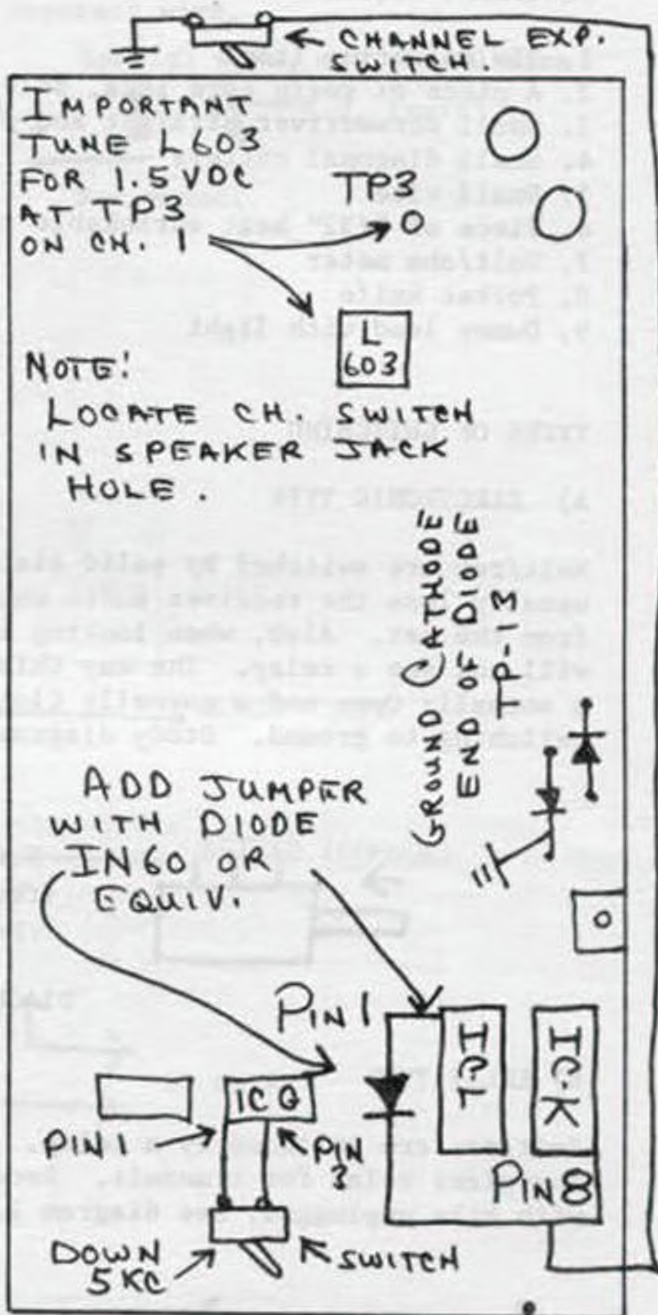
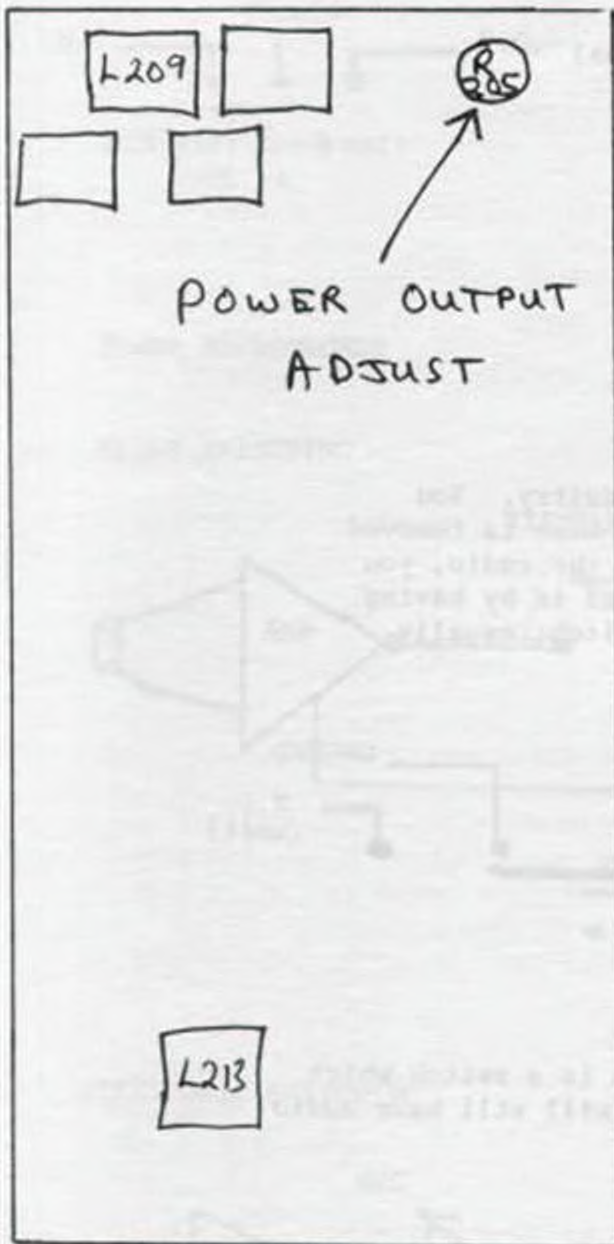

7H043 BRD

REAR VIEW

R557
PWR
CAL

TRANSMIT CLARIFIER JUMPERS

TP5 JUMP
1 AND 3

TP6 JUMP
1 AND 3

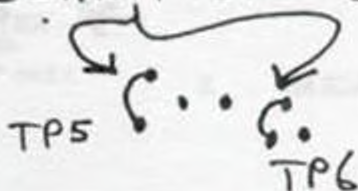

EQUIPMENT REQUIRED

1. 25W soldering iron
2. A piece of rosin core 18ga. solder
3. Small screwdriver (straight and phillips)
4. Small diagonal cutters
5. Small vice
6. Piece of 3/32" heat shrinkable tubing
7. Volt/ohm meter
8. Pocket knife
9. Dummy load with light

TYPES OF SWITCHING

A) ELECTRONIC TYPE

Xmit/rec are switched by solid state circuitry. You usually lose the receiver audio when the mike is removed from the set. Also, when looking inside the radio, you will not see a relay. The way this works is by having a normally Open and a normally Closed switch, usually switching to ground. Study diagram A.

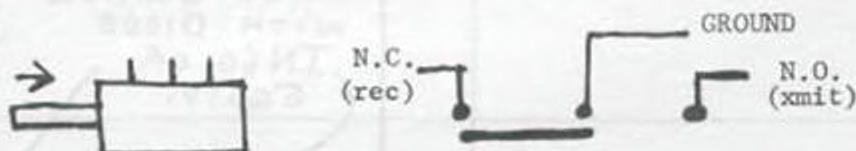

DIAGRAM A

B) RELAY TYPE

Xmit/rec are switched by a relay. There is a switch which energizes relay for transmit. Receiver will still have Audio with Mike unplugged. See diagram B.

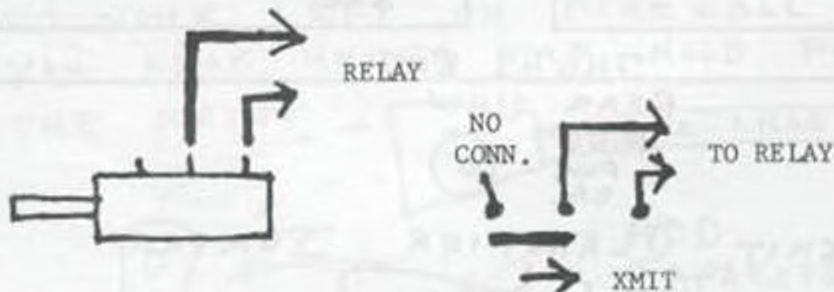

DIAGRAM B

C) SPECIAL TYPE

This has a separate wire for speaker switching and sometimes the common wire on N. O. and N.C. switches are not switched to ground but to a separate wire.



POWER MICROPHONES

RELAY SWITCHING

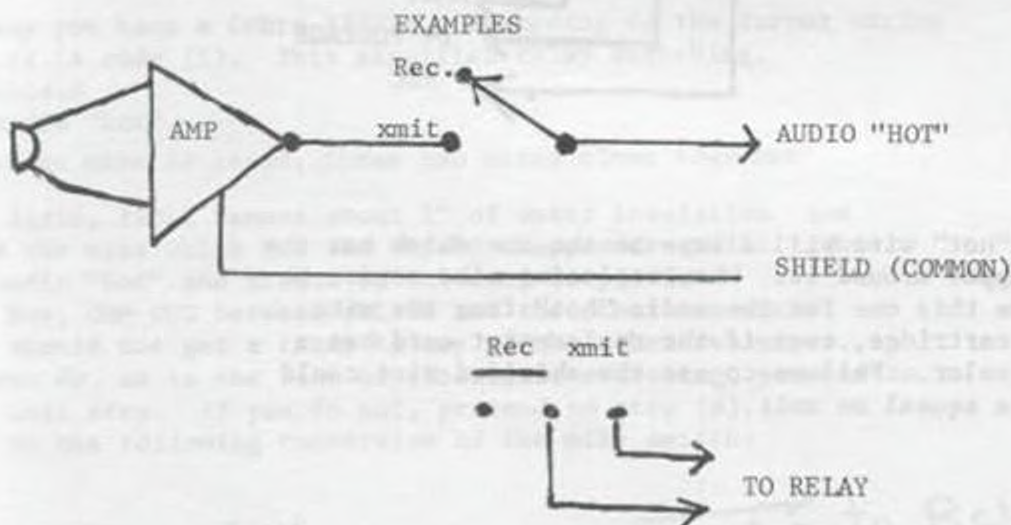

ELECTRONIC SWITCHING

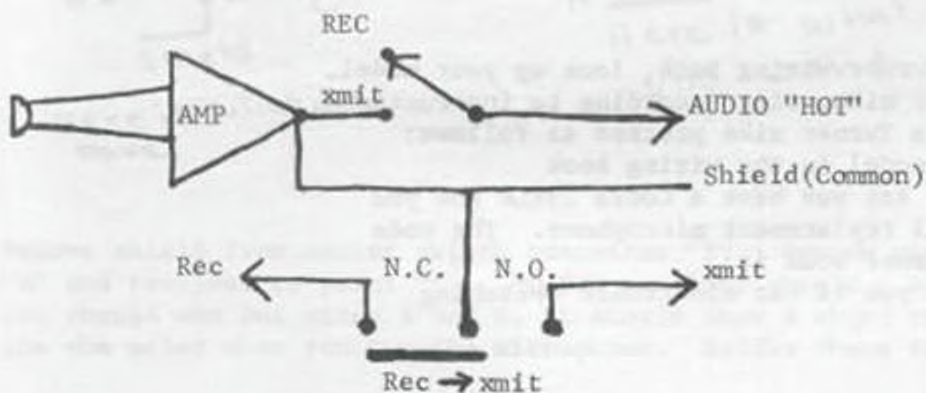

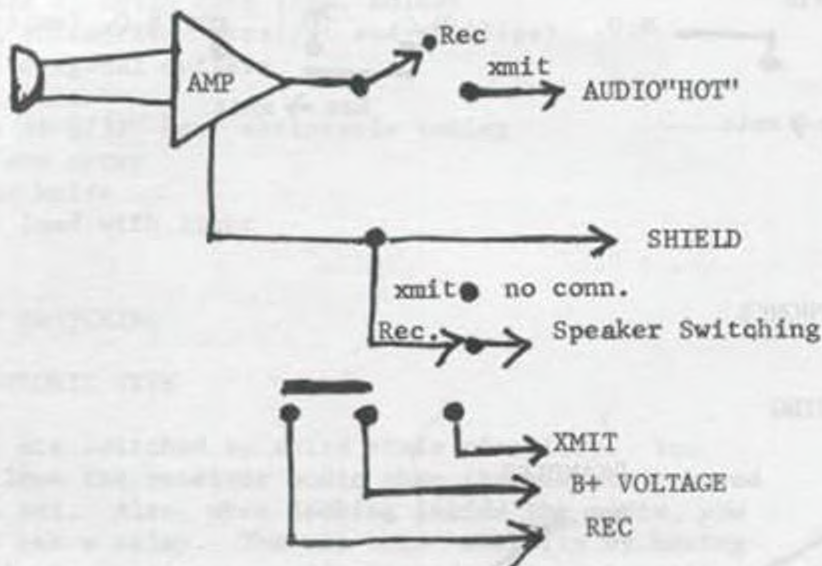

The audio "hot" wire will always be the one which has the shield wrapped around it. When replacing mike cords, be sure to use this one for the audio "hot" from the mike switch or cartridge, even if the replacement cord has a different color. Failure to use the shielded wire could result in a squeal on xmit.

HOW TO FIGURE OUT WIRING

EXAMPLES

1) If you have a Turner Wiring Book, look up your model. If you have a Turner mike, wire according to instructions. If you do not have a Turner mike proceed as follows:

a) Look up your model in the wiring book

For example, let's say you have a Cobra 29XLR and you bought a new general replacement microphone. The code according to the Turner book is:

Code (E) This tells you it has electronic switching

1-S (shield)

2-W (audio "hot")

3-BK (transmit)

4-R (receive)

b) Remove about 1" of outer insulation off mike cord. Look for wire that has shield wrapped around it. This is the modulation audio "hot" wire. Solder it to pin 2 in example 1. This wire is usually red or white.

c) Next, take your voltmeter on the RX 100 scale. Put one lead on the shield. Put the other lead on one of the remaining wires. If the motor deflects to zero, this is the Rec wire and should be connected to pin 4 in example 1. When you key the mike, the meter should deflect to the opposite end of the scale.

d) Now put the volt/ohm meter between the shield and the other remaining wire. The volt/ohm meter should read zero when the mike is keyed. Solder this wire to pin 3.

This is for electronic type switching.

EXAMPLE 2

Let's say you have a Cobra 138XLR. According to the Turner wiring book, it is code (R). This signifies relay switching.

1-S shield

2-W Audio "hot"

3-Blk when mike is keyed, these two wires close together

4-Red

a) Again, first remove about 1" of outer insulation and find the wire which has the shield wrapped around it. This is audio "hot" and should be soldered to pin 2.

b) Now, OHM OUT between shield and the other two wires. You should not get a reading to any of the other two wires. If you do, as in the case of electronic switching, proceed to the next step. If you do not, proceed to step (d).

c) Do the following conversion of the mike switch:

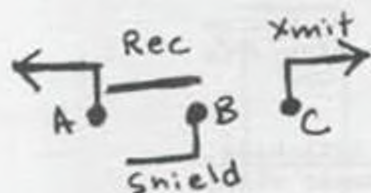

Here is what you have

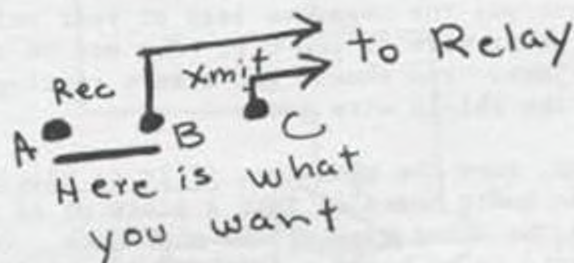

Remove shield from center switch connector "B". Remove wire "A" and resolder to point "B". DO NOT resolder shield. Now, you should ohm out wires B and C. It should show a short on the ohm meter when you key the microphone. Solder these two

wires to pins 3 and 4. Skip step (d).

d) Ohm out between the two remaining wires. You should get a zero reading when the mike is keyed. Solder these pins to 3 and 4. Here is what you have.

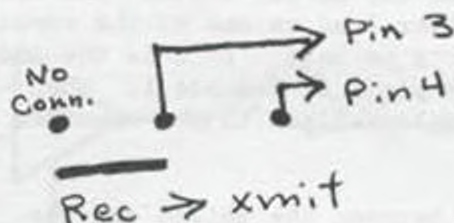

Now, let's take the case of having a radio, a mike, and no wiring book or instructions at all.

1) First, find the shielded wire, indicating your audio "hot" from the microphone. Also, ohm out the remaining wires to be sure you know if you have an electronic or relay switch on the mike. You should also be able to tell this by looking inside the microphone at the switch.

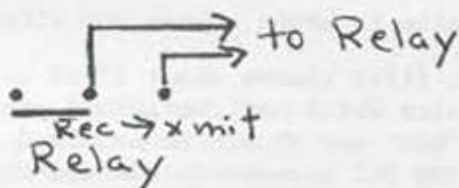
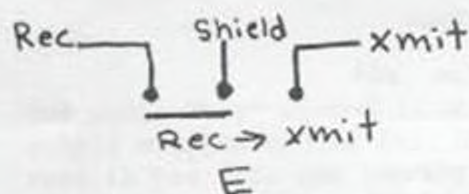

Turn on the radio, If you hear rec. audio, it is a relay switch. If you do not hear audio, it has an electronic switch.

2) Next put the negative lead of your volt/ohm meter on the black power wire on the C.B. Ohm out to the pins on the microphone jack. You should get a zero reading on one pin. This is where the shield wire goes.

3) Now, turn the radio on, if it is electronic type switching, (no rec audio heard). Take a piece of wire and jumper shield pin to the other pins of the mike jack. One pin should cause Rec audio to be heard, another pin should cause C.B. to xmit. Remaining pin will be audio "hot". If more than one pin is left, (as is the case where there are unused pins), solder shield, xmit and rec. wire and move audio "hot" wire to remaining pins until dummy load light blinks with modulation. Solder and assemble connector.

4) If the radio has relay type switch, (audio heard without mike), find the two pins that energize the relay by jumping between them. Then, with mike keyed, take the audio "hot" wire and connect it to the pin which causes the dummy load lamp to flash as you talk. Assemble connector.

* SPECIAL CURES FOR SPECIAL PROBLEMS*

If you hear a whistle in the rec audio when you plug in the mike, this usually indicates that the audio "hot" wire is grounded in rec.

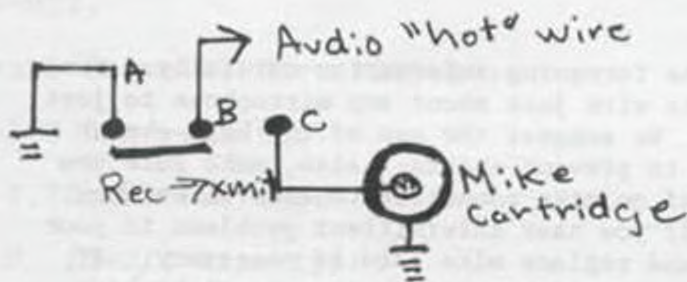

to fix this problem, unconnect ground from pin "A".

Sometimes you run across a mike that does not have switching on the audio "hot" lead. This will also cause a whistle on rec. The following is an example:

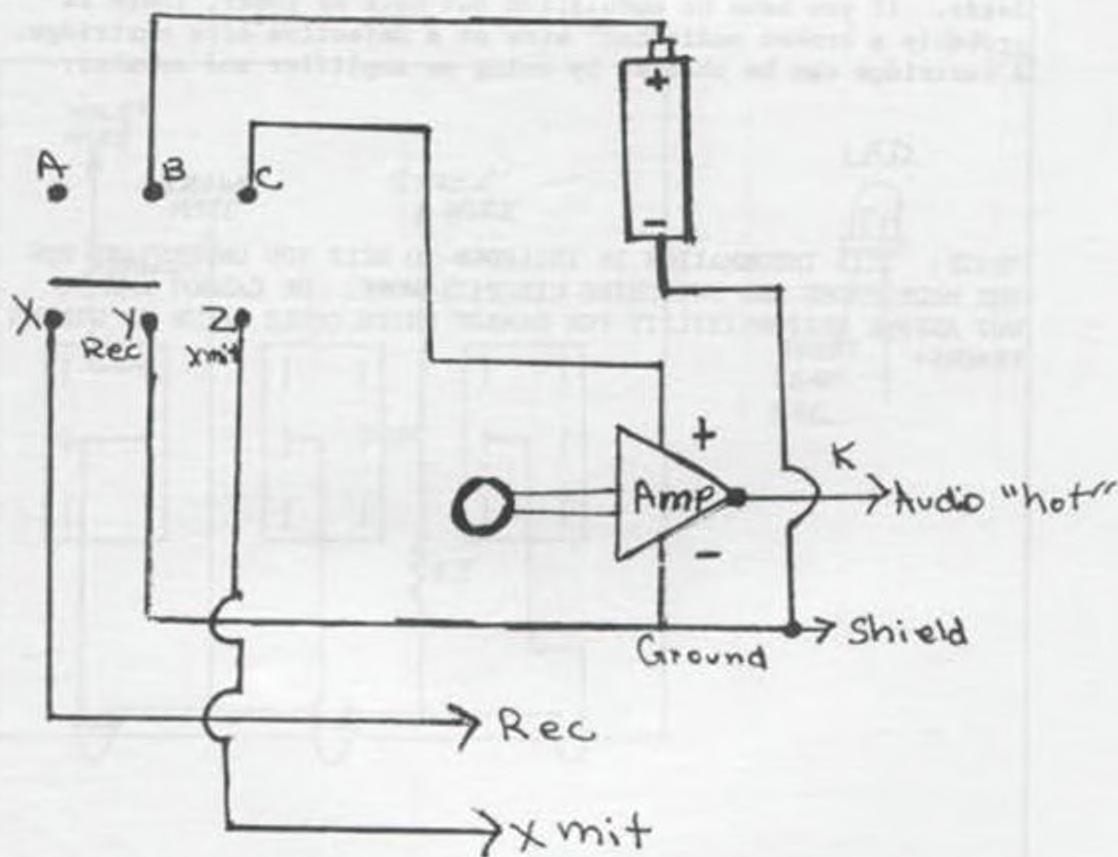

Unsolder negative lead from battery to shield wire. Solder the wire to pin 2 on switch. Make sure that your mike is wired like the diagram before any modifications are made. Pin Y must be connected to ground common. Now, remove Positive wire from battery at pin B. Also, remove wire from pin C. Connect the two wires together. Cut audio "hot" wire and solder one end to pin B. Solder other end to pin C. When the mike is keyed, pins B and C will be connected together so audio will pass thru while still being "open circuit" on rec.

Start by studying the foregoing information carefully. You should now be able to wire just about any microphone to just about any receiver. We suggest the use of the heat shrink tubing on the wires to prevent shorts. Also, make sure you tighten strain relief on mike connector to keep wires from being pulled out. If you have intermittent problems in your mike, clean switch and replace mike cord if necessary. If you have a squeal on xmit with a power mike you might have to insert a 45-55 uh RF choke or 3-20k ohm resistor in series with audio "hot" lead.

If you have a Turner desk mike with a squeal in rec., you must install an additional switch kit, available from Turner, 909 17th St. NE, Cedar Rapids, Iowa, 52402. These kits will also fit other desk mikes such as the GC.

If radio transmits without keying mike, reverse the Rec/ Xmit leads. If you have no modulation but have RF power, there is probably a broken audio "hot" wire or a defective mike cartridge. A cartridge can be checked by using an amplifier and speaker.

NOTE: THIS INFORMATION IS INCLUDED TO HELP YOU UNDERSTAND HOW THE MICROPHONE AND SWITCHING CIRCUITS WORK. WE CANNOT AND DO NOT ASSUME RESPONSIBILITY FOR DAMAGE WHICH COULD OCCUR BY WIRING ERRORS

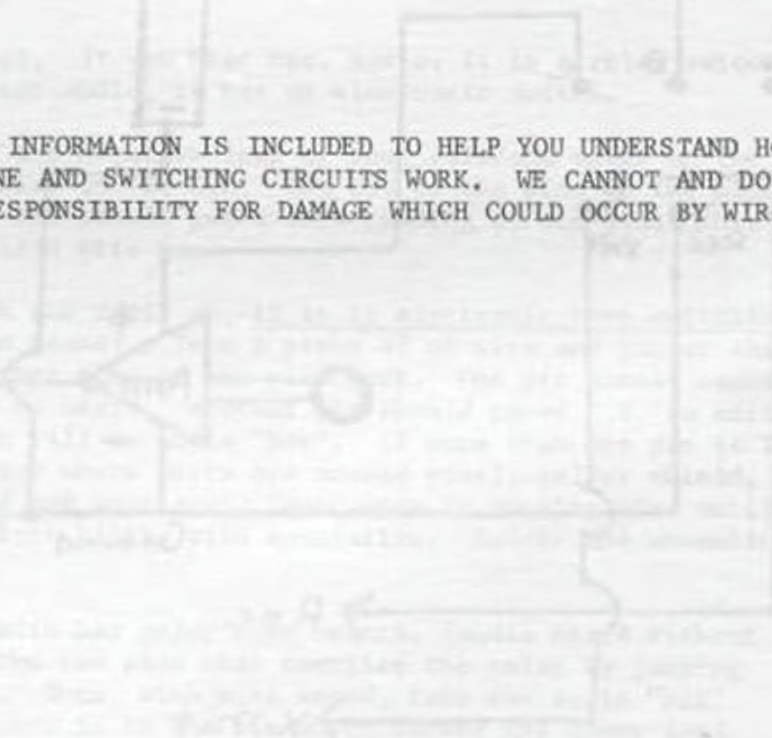

PLL CHANNELIZER
PARTS LIST & EXPANDED DIAGRAM

PARTS LIST:

1. G.C. Electronics 3 station push button switch (interlock type) part #35-922.
2. Radio Shack Chassis, Part #270-251
3. $\frac{1}{2}$ watt, 150 ohm resistor
4. $\frac{1}{2}$ watt, 4.7K ohm resistor
5. Red L.E.D. (1-3/4 size type)
6. Green L.E.D. (1-3/4 size type)
7. Yellow L.E.D. (1-3/4 size type)

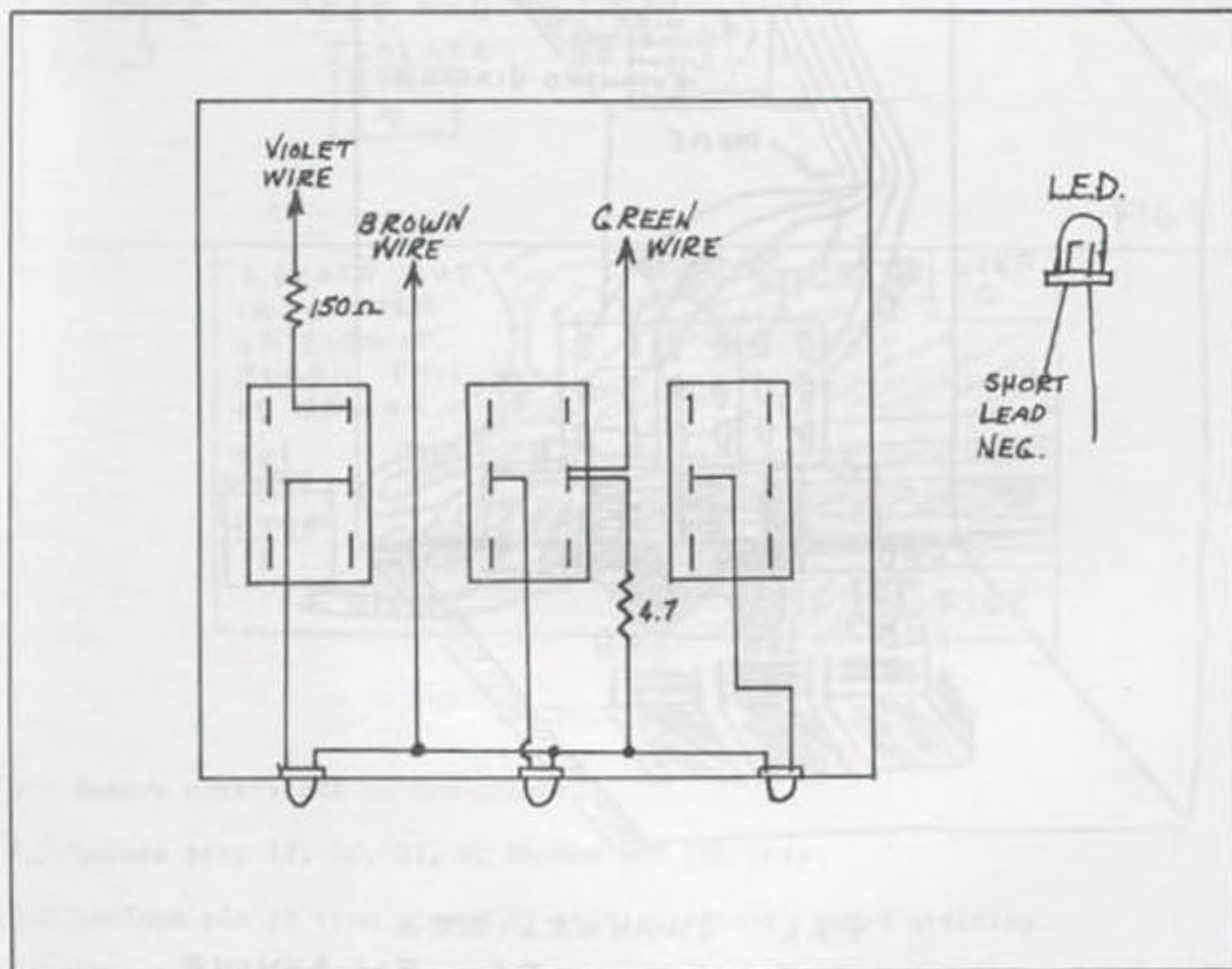

PLL CHANNELIZER DIAGRAM

* NOTE PARTIAL DIAGRAM,
SEE EXPANDED DIAGRAM
FOR MORE COMPLETE WIRING
OF LED'S.

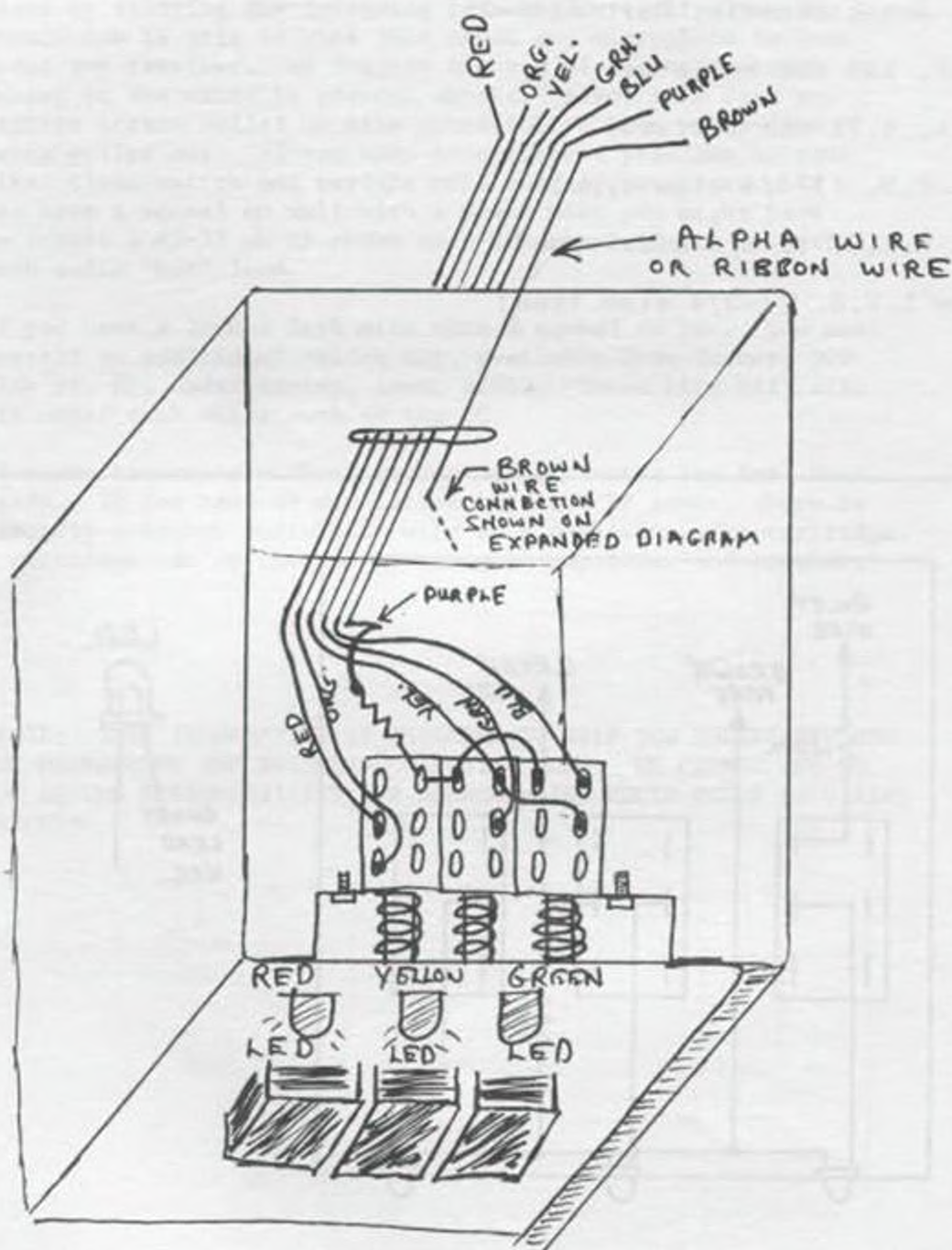

PLL CHANNELIZER
THIS UNIT IS NOT MFG. BY ANYONE
INCLUDING SECRET CB.

PLL CHANNELIZER

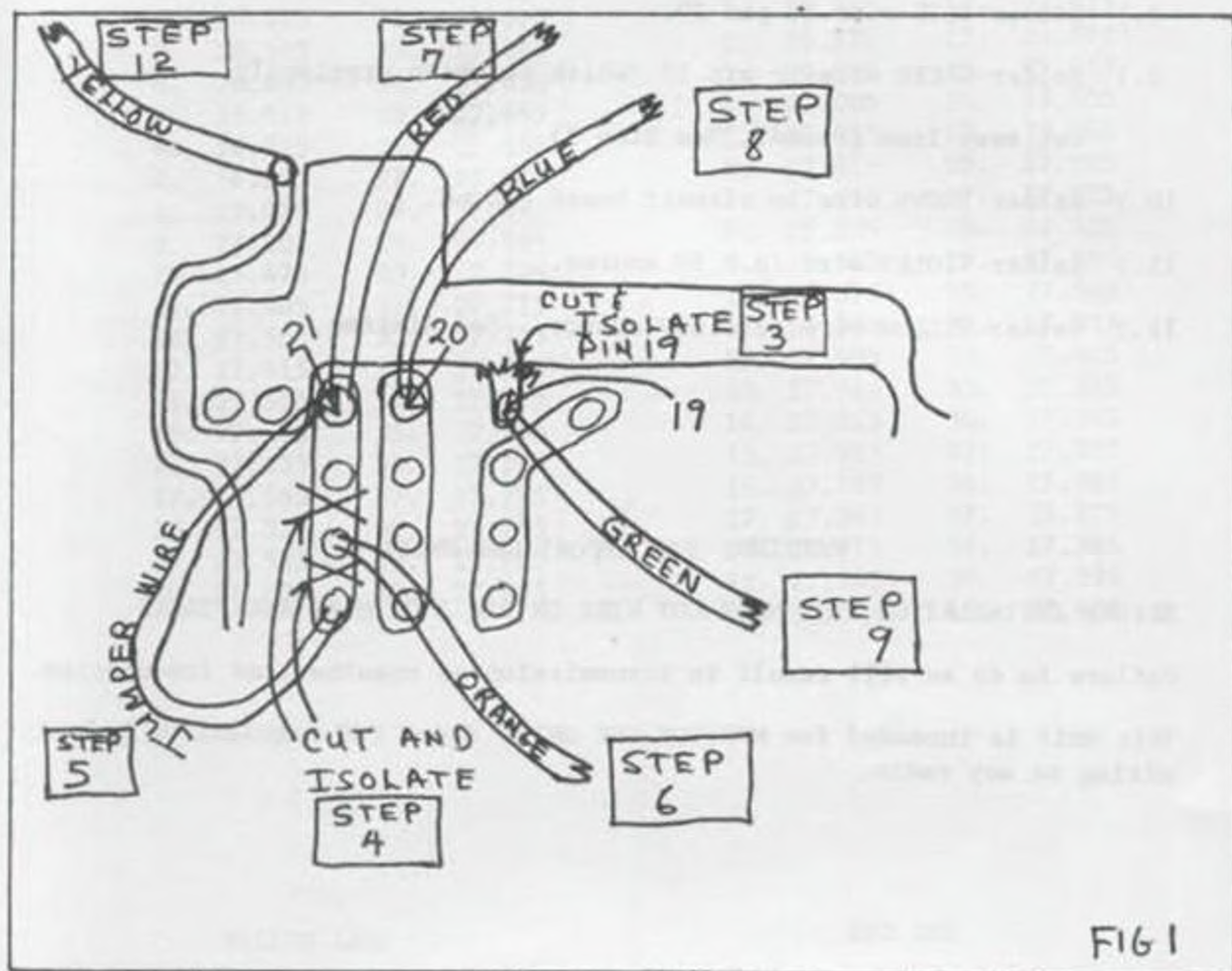

FIG 1

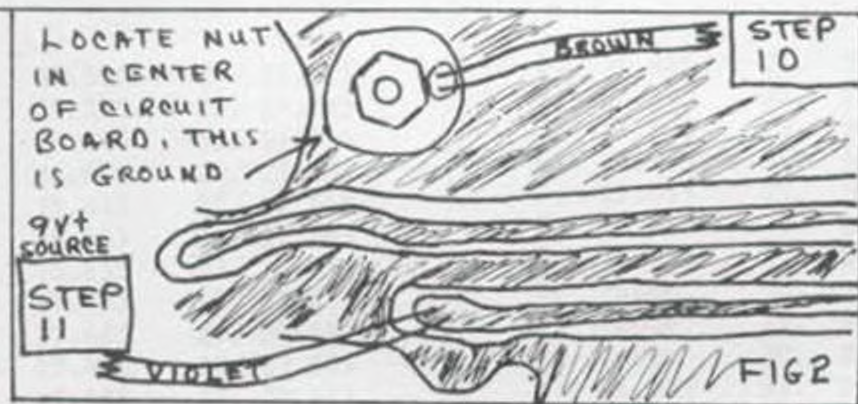

FIG 2

INSTRUCTIONS:

- 1.) Remove covers off of tranceiver.
- 2.) Locate pins 19, 20, 21, of Uniden 858 PLL chip.
- 3.) Isolate pin 19 from ground by cutting circuit board printing.
- 4.) Make 2 cuts on pin 21 as shown in diagram.
- 5.) Solder jumper wire on pin 21 as shown.

- 6.) Solder ORANGE wire to isolated pin on 21.
- 7.) Solder RED wire to pin 21.
- 8.) Solder BLUE wire to pin 20.
- 9.) Solder GREEN wire to pin 19 (which has been previously cut away from ground. See Step 3)
- 10.) Solder BROWN wire to circuit board ground.
- 11.) Solder VIOLET wire to + 9V source.
- 12.) Solder YELLOW wire to 4.68V source. See diagram.

WARNING: FOR EXPORT USE ONLY!

BEFORE INSTALLATION, YOU MUST CUT WIRE ON PIN 3 OF MIKE RECEPTACLE.

Failure to do so will result in transmission on unauthorized frequencies.

This unit is intended for MONITOR USE ONLY. Check FCC regulations before wiring to any radio.

YELLOW & GREEN LED

GREEN LED

1.	26.565	21.	27.615
2.	26.575	22.	27.625
3.	26.585	23.	27.655
4.	26.605	24.	27.635
5.	26.615	25.	27.645
6.	26.625	26.	27.665
7.	26.635	27.	27.675
8.	27.455	28.	27.685
9.	27.465	29.	27.695
10.	27.475	30.	27.705
11.	27.485	31.	27.715
12.	27.505	32.	27.725
13.	27.515	33.	27.735
14.	27.525	34.	27.745
15.	27.535	35.	27.755
16.	27.555	36.	27.765
17.	27.565	37.	27.775
18.	27.575	38.	27.785
19.	27.585	39.	27.795
20.	27.605	40.	27.805

1.	26.965	21.	28.015
2.	26.975	22.	28.025
3.	26.985	23.	27.255
4.	27.005	24.	28.035
5.	27.015	25.	28.045
6.	27.025	26.	27.265
7.	27.035	27.	27.275
8.	27.855	28.	27.285
9.	27.865	29.	27.295
10.	27.875	30.	27.305
11.	27.885	31.	27.315
12.	27.905	32.	27.325
13.	27.915	33.	27.335
14.	27.925	34.	27.345
15.	27.935	35.	27.355
16.	27.955	36.	27.365
17.	27.965	37.	27.375
18.	27.975	38.	27.385
19.	27.985	39.	27.395
20.	28.005	40.	27.405

YELLOW LED

RED LED

1.	26.565	21.	27.615
2.	26.575	22.	27.625
3.	26.585	23.	27.655
4.	26.605	24.	27.635
5.	26.615	25.	27.645
6.	26.625	26.	27.665
7.	26.635	27.	27.675
8.	27.455	28.	27.685
9.	27.465	29.	27.695
10.	27.475	30.	27.705
11.	27.485	31.	27.715
12.	27.505	32.	27.725
13.	27.515	33.	27.735
14.	27.525	34.	27.745
15.	27.535	35.	27.755
16.	27.555	36.	27.765
17.	27.565	37.	27.775
18.	27.575	38.	27.785
19.	27.585	39.	27.795
20.	27.605	40.	27.805

1.	26.965	21.	26.215
2.	26.975	22.	26.225
3.	26.985	23.	26.255
4.	27.005	24.	26.235
5.	27.015	25.	26.245
6.	27.025	26.	26.265
7.	27.035	27.	26.275
8.	none	28.	26.285
9.	none	29.	26.295
10.	none	30.	26.305
11.	26.085	31.	26.315
12.	26.105	32.	26.325
13.	26.115	33.	26.335
14.	26.125	34.	26.345
15.	26.135	35.	26.355
16.	26.155	36.	26.365
17.	26.165	37.	26.375
18.	26.175	38.	26.385
19.	26.185	39.	26.395
20.	26.205	40.	26.405

RED & GREEN LED

1.	26.965	21.	27.015
2.	26.975	22.	27.025
3.	26.985	23.	26.255
4.	27.005	24.	27.035
5.	27.015	25.	27.045
6.	27.025	26.	26.265
7.	27.035	27.	26.275
8.	26.855	28.	26.285
9.	26.865	29.	26.295
10.	26.875	30.	26.305
11.	26.885	31.	26.315
12.	26.905	32.	26.325
13.	26.915	33.	26.335
14.	26.925	34.	26.345
15.	26.935	35.	26.355
16.	26.955	36.	26.365
17.	26.965	37.	26.375
18.	26.975	38.	26.385
19.	26.985	39.	26.395
20.	27.005	40.	26.405

RED & YELLOW LED

1.	26.565	21.	26.615
2.	26.575	22.	26.625
3.	26.585	23.	26.635
4.	26.605	24.	26.635
5.	26.615	25.	26.645
6.	26.625	26.	26.665
7.	26.635	27.	26.675
8.	26.455	28.	26.685
9.	26.465	29.	26.695
10.	26.475	30.	26.705
11.	26.485	31.	26.715
12.	26.505	32.	26.725
13.	26.515	33.	26.735
14.	26.525	34.	26.745
15.	26.535	35.	26.755
16.	26.555	36.	26.765
17.	26.565	37.	26.775
18.	26.575	38.	26.785
19.	26.585	39.	26.795
20.	26.605	40.	26.805

The frequencies will be the same as above if all three buttons are depressed simultaneously.

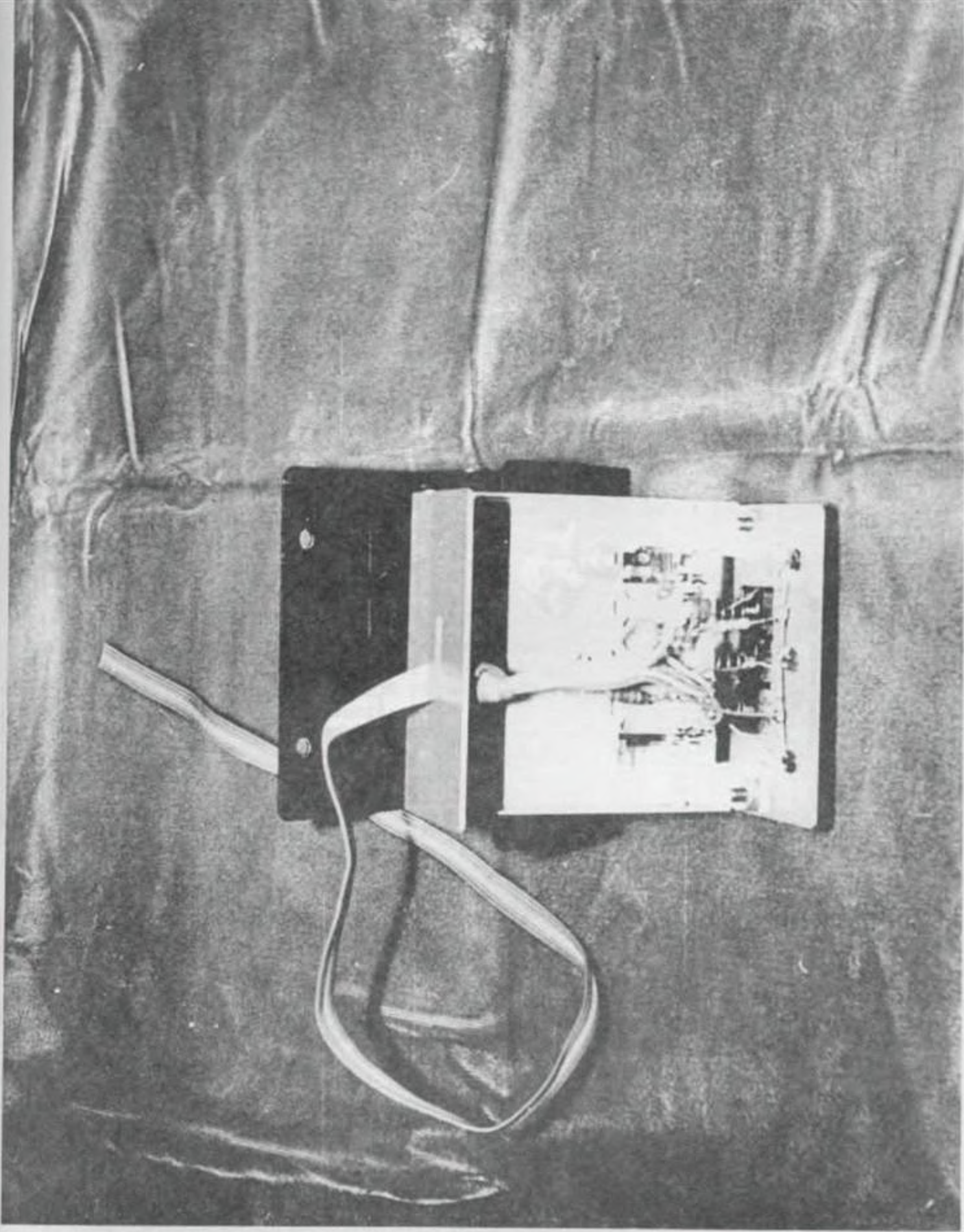

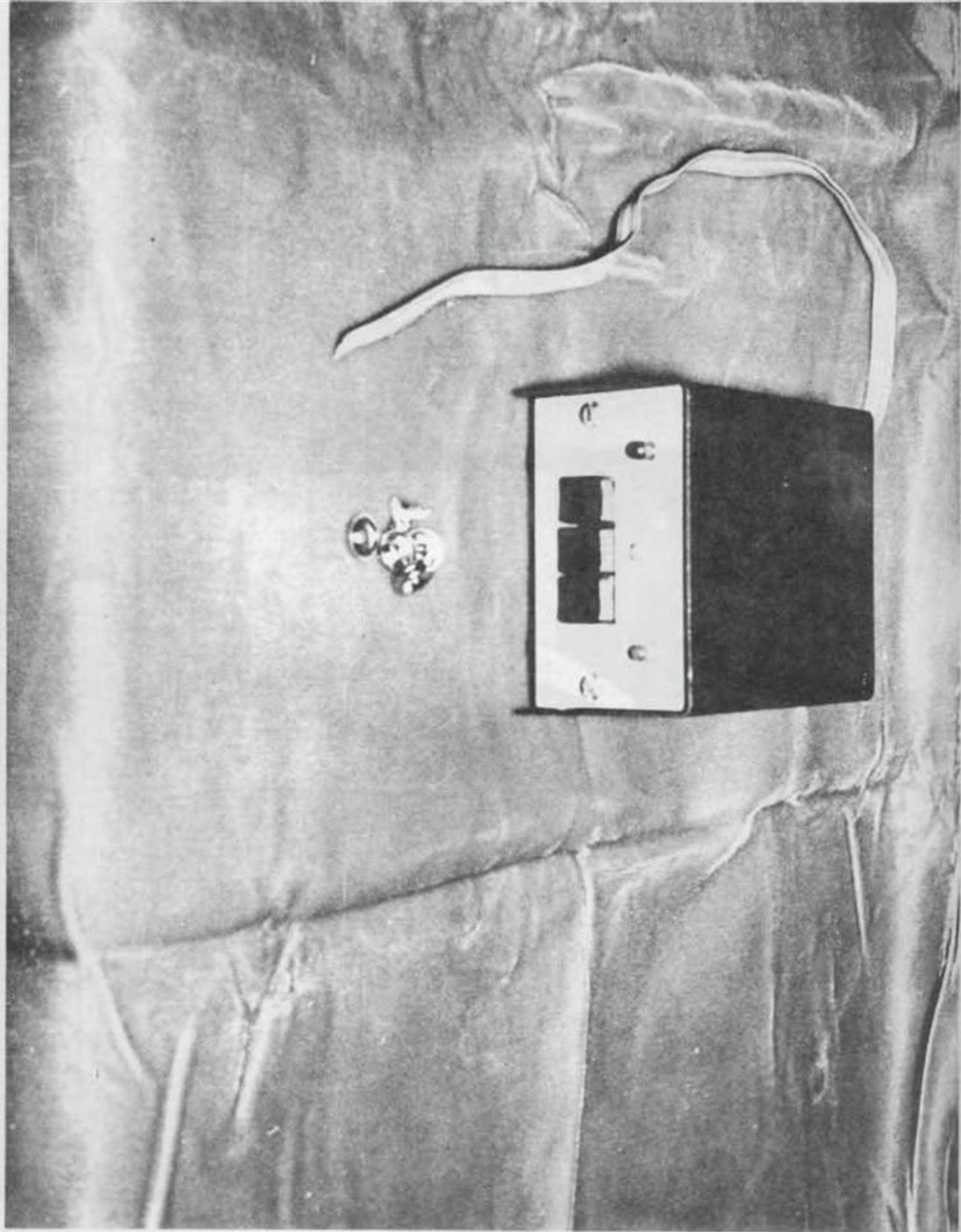

AUTOMATIC MODEL CBH2265

Adjust L202 and L205 for maximum AM power.
Adjust R207 for 100% modulation or clip D201.
R227: RF meter adjustment
R153: S meter adjustment
Connect pins P6 and P7 off PLL for new frequencies.

BOMAN CBR9600

Adjust L111 and L113 for maximum RF power.
Adjust RV105 for 100% modulation.
RV104: RF panel meter adjustment
RV102: S meter adjustment
Connect pins 18 and 19 of IC101(UPD858c)
together and jump both to pin 21 for new
frequencies.

ALARON B-5200

Adjust L5, L8, and L9 for maximum RF power.
Adjust VR4 for 100% modulation.
VR6: RF meter adjustment
VR5: S meter adjustment
L10: TVI trap adjustment

AUDIOVOX MCB750

Adjust T7, L3, and L4 for maximum RF power.
Adjust VR3 for 100% modulation or clip D9.
Connect pins 9 and 10 of M20 PLL OSC unit
together for new frequencies.

COBRA 21 GTL/ 25GTL

Adjust L10 for maximum RF power.
Adjust VR5 for 100% modulation.
VR3: TX power meter adjustment
VR1: S meter adjustment

FANON FANFARE 182F

Adjust T13, L9 for maximum RF output.
Adjust VR9 for 100% modulation.
VR6: TX power meter adjustment
Connect pin 8 to pin 10 of Rec86345 PLL for
new frequencies. Connect pins 10 and 11 of PLL
together for new frequencies.

GEMTRONICS GTX5000

Adjust L702 (top) , VC901, and VC902 for maximum RF power.
Adjust VR4 for 100% modulation.
VR7B: RF meter adjustment
VR1: S meter adjustment
Connect pin 3 of Q13 MSM5907 IC chip to pin
5 of same chip for more frequencies. Also
connect pin 2 to pin 5 for more frequencies.

GENERAL ELECTRIC 3-5830

Adjust L6, L4, L1, and L3 for maximum RF power.
Adjust VR2 for 100% modulation.
VR1 ; RF meter adjustment
VR102: S meter adjustment

KRACO KCB4003

Adjust T206, L203, L204, L205, and L206 for maximum
power.
Adjust VR202 for 100% modulation.
VR203: RF panel meter adjustment
VR102: S meter adjustment
Connect pins 9 and 10 together of IC1 NIS 7264B
for new frequencies.

MIDLAND 77-821

Adjust L4, L8, and L9 for maximum power on AM
Adjust RV2 for 100% modulation.
RV4: Power meter adjustment
Connect pins 9 and 10 of IC1 PLL03A together
for more frequencies.

MIDLAND 77-963

Adjust L7, L11, and L12 for maximum RF power.
Adjust RV2 for 100% modulation.
RV4 : Power meter adjustment
RV3 : S meter adjustment
RV501: SWR meter adjustment.
Connect pins 9 and 10 of IC1 PLL02A
together for more frequencies.

ALARON

Adjust VR402 for RF power meter adjustment.
Adjust L403 and L406 for maximum power.
Cut D207 for 100% modulation.
Connect pin 2 of IC1 to 6.24V source for more frequencies.

BOMAN CB950

Adjust VR4 for maximum AM power.
Adjust RV 2 for maximum SSB power.
Adjust RV 12 for 100% modulation.
RV3: RF panel meter adjustment.

COURIER CLASSIC PLL40

Adjust L903, and L906 for maximum power.
Adjust VR6 for 100% modulation.
VR7: RF panel meter adjustment.

COBRA 46XLR

Adjust L109 for maximum power.
Adjust VR105 for 100% modulation.
VR104; RF panel meter adjustment.

COBRA 50XLR

Adjust VR5 for 100% modulation.

COBRA 55XLR

Adjust VR5 for 100% modulation.

COURIER FANON ROGUE 40 and FANFARE 125F

Adjust T14, T13, and L9 for maximum power.
Adjust VR5 for 100% modulation.
Adjust T12 for minimum interference to TV to 54 mhz harmonic.
VR6: RF panel meter adjustment.
Connect pin 10 of U1 to 4.83V source and connect pin 11 of U1 to 4.83V source for more frequencies.

Specific Radio Tune-ups

BOMAN CB 555

VR 481: Adjust for 100% modulation
VR 491: RF meter adjustment
Adjust I451 and I464 for maximum RF power
VR 151: S meter adjustment

BOMAN CBH 900

Adjust L7, L11, L12 for maximum RF power
RV1a: Adjust to obtain 13.8 volts power
RV2 : Adjust for 100% modulation
RV3 : S meter adjustment
RV4 : RF meter adjustment
Connect pins 9 and 10 of IC1 together for more frequencies.

BOMAN CB 910

Adjust L7, L11, and L12 for maximum RF power
RV2: Adjust for 100% modulation
RV4: RF meter adjustment **SEE MASTER COPY B & C.**

Connect pin 9 to pin 7 of IC1 for more frequencies (channels 10-40) or connect pins 9 and 10 together for more frequencies.

BOMAN CB930

Adjust L7, L11, and L12 for maximum RF power
RV2: Adjust for 100% modulation
RV4: RF meter adjustment
RV3: S meter adjustment
SEE MASTER COPY B & C

BOMAN CBR 9940

VR 903: Adjust for 100% modulation
VR 902: Adjust in addition to VR 903 for maximum modulation
VR 901: Adjust for maximum power

COBRA 29GTL

VR4: Adjust for 100% modulation

COBRA 47XLR

Adjust L109 for maximum RF power

VR 105: Adjust for 100% modulation

VR 104: RF meter adjustment

Connect pin 11 of IC101(MB8719) to pin 9

COBRA 86XLR

Adjust L6 and L3 for maximum RF power

R4: RF meter adjustment

R17: S meter adjustment

Take pin 8 low by cutting print and adding a 4.7k resistor across cut. Add a switch, one side to ground, other side to pin 8 of IC10.

COBRA 132XLR

Adjust L7 and L3 for maximum RF power

R134: Adjust for 100% modulation

R9 : RF meter adjustment

R130: SSB automatic level control maximum adjustment

R93 : modulation meter adjustment

Connect pins 7 and 8 of IC304 together for more frequencies.

COBRA 135XLR

Adjust L7 and L3 for maximum power

Adjust T7 for maximum RF output on SSB

R130: Adjust for maximum power SSB automatic level control

R134: Adjust for 100% modulation

R9 : RF panel meter adjustment

CLARION DMA066, JC202E, RCJ003

Adjust L205, L204, L203, L201 for maximum power

VR201: Adjust for 100% modulation

COURIER RENEGADE 40

Adjust T13 and L9 for maximum RF power output

Adjust VR9 for 100% modulation or cut D12

VR6- TX power meter adjustment

Take pin 11 of U1 divider chip to 4.69v for more frequencies, (channels 1-27)

COURIER NIGHTRIDER 40DR

Adjust L116, L118, L119, L120 for maximum power

VR103: RF panel meter adjustment

VR301: Mike gain adjustment for 100% modulation

Connect pin 11 of IC202 to pin 9 of IC202 for more frequencies

FANON FANFARE 185PLL

Adjust L116, L118, L119, L120 for maximum RF power

VR 301: Adjust for 100% modulation

VR 103: RF panel meter adjustment

Isolate pin 11 of IC202 from ground

Add a 4.7k ohm resistor from pin 11 to ground

Connect pin 11 to pin 9

GM 4175

CR 14: Clip for 100% modulation

T 18 : Adjust for maximum AM power

Connect pin 6 of U201 to pin 13 of U201 more frequencies- channels 1-34

GENERAL ELECTRIC 3-5871B

VR 12: Adjust for 13.8V DC

VR 11: Adjust for 100% modulation

VR 10: RF meter adjustment

VR 9 : S meter adjustment

VR 6 : RF gain adjustment

Adjust L903, L905 for maximum RF power

Connect pin 14 of IC801 (LC7110PLL) to pin 13 and/ or connect pin 15 to pin 13

GM 4120

Adjust T8, L3, L4, L6 for maximum RF power

Cut CR12 for 100% modulation

Take pin 13 of U101 high (10-30V) for more frequencies

FANON FANFARE 184DF

Adjust T14, T13, and T9 for maximum AM power.
Adjust VR9 for 100% modulation.
Adjust T12 for minimum interference on TV to 54mhz.
Adjust VR6 for RF panel meter.
Connect pin 10 of U1PLL to 4.82 volt source and connect pin 11 to 4.82V source for more channels.

FANON FANFARE 190DF

Adjust L116, L118, L119, and L120 for maximum power.
Adjust VR301 for 100% modulation.

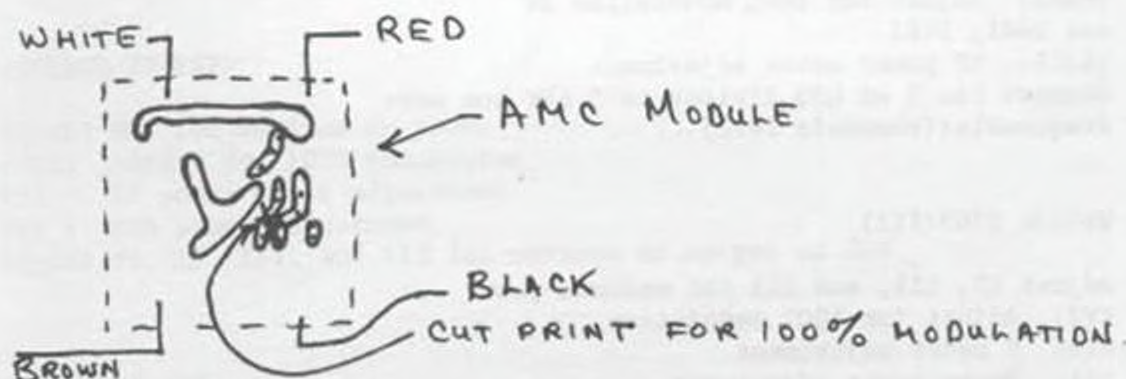

FANON FANFARE 350F

Adjust VR6 for maximum AM power.
Adjust VR7 for maximum SSB power.
Adjust VR8 for 100% modulation.
Adjust VR3 for local/DX adjustment.
Adjust VR9 for RF panel meter adjustment.
Connect pin 20 of IC2 PLL to pin 21 for more frequencies(channels 8-40).

JOHNSON MESSENGER 4120

Adjust T8, L3, L4, and L6 for maximum power.
Clip CR12 for 100% modulation.
Connect pin 13 of U101 to 10.30V source for more frequencies.

JOHNSON MESSENGER 4170/75

Adjust T17, T18, L5, L6, and L7 for maximum power.
Cut CR14 for 100% modulation.
Connect pin 13 of U201 to 10.21V source for more frequencies.

GENERAL MOTORS CBD-203 (CB module to AM/FM/8 track radio)

RV2: Adjust for modulation
Adjust L5, L8, and L9 for maximum power

GEMTRONICS GT 55

RV2: Adjust for 100% modulation
RV4: RF panel meter adjustment
RV3: S meter adjustment
Adjust L7, L11, L12 for maximum RF power
See conversion for Boman 930 for additional frequencies

GEMTRONICS GTX 4040

ADJUST L451 and 463 for maximum RF power
VR481: Adjust for 100% modulation or
cut D481, D482
VR511: RF power meter adjustment
Connect Pin 3 of Q35 divider to 5.68V for more
frequencies(channels 1-27)

HYGAIN 2703(III)

Adjust L7, L11, and L12 for maximum power
RV2: Adjust for 100% modulation
RV3: S meter adjustment
RV4: Power meter adjustment
* See conversion for Boman 930 for additional
frequencies

JOHNSON MESSENGER 4135

Adjust T8, L3, and L4 for maximum RF power
R202: S meter adjustment
Connect pin 13 of U101 (3001-201) to pin 12
Clip CR12 for 100% modulation

HYGAIN 2702

Adjust L7, L11, and L12 for maximum RF power
RV2: Adjust for 100% modulation
RV3: S meter adjustment
RV4: RF panel meter adjustment
* See Boman CB930 for adding more frequencies

JOHNSON MESSENGER 4250

Clip CR12 for 100% modulation
Adjust T8, L3, L4, L6 for maximum power
Connect pin 6 and pin 13 of U101 divider for
more frequencies (channels 1-34)

Adjust L7, L11, and L12 for maximum AM power
 RV2: Adjust for 100% modulation
 RV3: S meter adjustment
 RV4: RF panel meter adjustment
 * See conversion for Bowman CB930 for more frequencies

JOHNSON VIKING 260/270

Adjust L84 for maximum RF power
 Adjust R49 for 100% modulation +T84 +T85
 for cleanest RF envelope
 Connect pins 13 and 14 of U131 together for more frequencies

MIDLAND 79-892

ADJUST VR4 for maximum AM power
 RV12: Adjust for 100% modulation
 RV3: RF power meter adjustment
 RV2: SSB power adjustment
 Adjust T6, L7, L11, and L13 for maximum RF output of USB

MIDLAND76-858

Adjust L7, L11, and L12 for maximum RF power
 RV2: Adjust for 100% modulation
 RV4: Adjustment for RF power meter
 RV3: S meter adjustment
 * See conversion for Boman CB930 for high frequencies

PIERCE SIMPSON LEOPARD B

VR901: Adjust for maximum RF power
 VR903: Adjust for 100% modulation
 VR902: Also adjust for modulation

MOPAR 4094177

Adjust L7, L11, and L12 for maximum RF power output
 RV4: TX meter adjustment
 RV3: S meter adjustment
 Connect pins 9 and 10 of IC1 together for more frequencies

MIDLAND 77-849

Adjust L7, L11, and L12 for maximum power.
Adjust RV2 for 100% modulation.
RV4: RF panel adjustment.
Connect pins 9 and 10 of IC1 together for more frequencies.

MIDLAND 76-863

Adjust L7, L11, and L12 for maximum power.
Adjust RV2 for 100% modulation.
RV521: Antenna warning light adjustment.
Connect pin 9 of IC1 to pin 10 of IC1 for more frequencies.

MOTOROLA T4000A/05A/10A/20A

Cut VR305 and CR206 for 100% modulation.

MIDLAND 77-861

Adjust T5, L4, L5, and L13 for maximum power.
Adjust VR1 for lo power set.
Cut D2 for 100% modulation.
VR2: RF panel adjustment.
Connect pin 10 of IC101 to 4.70V source for more frequencies.

KRACO KCB 4088

Adjust VR104 for 100% modulation.

MEDALLION 63-240

Adjust VR2 for 100% modulation.
Tune L6, L4, L3, and L1 for maximum power.
Adjust VR1 for RF panel meter adjustment.
Connect pin 6 of PLL to 7.45V source and connect pin 7 of PLL to 7.45v source for more frequencies.

GENERAL ELECTRIC 3-5800A

Adjust VR5 for maximum modulation.

Adjust L311, L310, L319, and L317 for maximum RF output

VR401: Adjust to obtain 9 volts
 VR402: Adjust for 100% modulation
 VR301: RF panel meter adjustment
 VR303: S meter adjustment

Connect pins 9 and 10 of M7 pins (green+blue wires) together

REALISTIC TRC448

VR203: RF meter adjustment
 VR210: AM power adjustment
 VR202: SSB power adjustment
 VR5 : Adjust for 100% modulation
 VR205: Adjustment for receiving meter

REALISTIC TRC466

Adjust L104, L106 for maximum RF power output
 Cut D110 and D111 for 100% modulation

REALISTIC TRC461

Adjust L11, L14, and L15 for maximum RF output
 Adjust VR5 for AM power
 Adjust VR2 for 100% modulation or cut D11
 Take pin 7 and 8 of IC2 high (5V) for more frequencies

Adjust L7, L11, and L12 for maximum RF power
 RV2: Adjust for 100% modulation
 RV4: RF power meter adjustment
 Connect pins 9 and 10 of IC1 divider together for more frequencies

REALISTIC TRC449

Adjust L32, L30 for maximum power
 CT7: Maximum SSB power
 VR8: AM power adjustment
 VR6: Micgain adjustment
 VR7: Adjustment for 100% modulation
 VR12: TX power meter adjustment
 Isolate pin 19 of IC7 from ground. Connect pin 19 to pin 21 for more channels (8-40).
 Change R162 from a 4.7K to a 1K ohm resistor.
 Clip D30 and R119 and D32. Make a jump from + of C135 to + C110. Move violet/white wire from clarifier to ground. Adjust L37 to accommodate new high frequency.

ROBYN LB120

Adjust L13, L12, L11, L10 for maximum RF output
Adjust VR6 for 100% modulation
VR4: RF meter adjustment

ROBYN 007-140

Adjust L15, L13, L12, L11, and L10 for maximum power
Adjust VR6 or clip D15 for 100% modulation
VR4: RF meter adjustment
VR5: S meter adjustment

ROBYN AM500D

Adjust L15, L12 for maximum RF output
Adjust VR5 for 100% modulation
VR4: RF meter adjustment
VR1: S meter adjustment
Connect pin 19 of IC3 to pin 7 of IC3

REALISTIC TRC452

Adjust L212 and L214 for maximum RF power
Adjust VR207 for 100% modulation or cut D213
VR206: RF panel meter adjustment
VR205: RX panel meter adjustment
Connect pin 22 of IC4 uPD858C to pin 12
Connect pin 18 of IC4 to pin 12

ROYCE 1-680

Adjust T402 for maximum RF output
Cut D301 for 100% modulation
Take pins 6 and 5 of PLL1 high (7.27V) for more frequencies

ROYCE 1-617

Adjust L311, L310, L319, and L317 for maximum RF output
Adjust VR401 for RF panel meter adjustment
Connect Blue and Green on PLL plug J5 together for more frequencies

ROYCE 1-673

Adjust T402, L403, L404 for maximum RF power
Clip D301 for 100% modulation
Connect pins 5 and 6 to pin 17 of PLL1

ROYCE 1-675

Adjust T402, L403, and L404 for maximum RF output
Cut D301 for 100% modulation
Connect pin 5 of PLL1 to pin 21 for more frequencies

RCA 14T302

Adjust T6, L7, L13 for maximum RF power output
Adjust VR4 for AM power adjustment
RV2: SSB power adjustment
RV12: Adjust for modulation
RV3: Power meter adjustment
RV501: SWR adjustment

SBE 47CB

Adjust L11, L14, and L15 for maximum RF output
VR3: Mike gain adjustment
VR4: Adjust for 100% modulation or cut D17
VR6: RF meter adjustment
Connect pins 5 and 6 together on IC5

SBE 43 CB

Adjust L6, L8, L9 for maximum RF power
Adjust R4 and R12 for 100% modulation
VR6: RF panel meter adjustment
VR7: S meter adjustment

SBE 49CB Tahoe 40

Adjust L34 and L37 for maximum RF power
Adjust R121 for 100% modulation
R180 S meter adjustment

SHAKESPEARE GBS 240

Adjust L451, L463 for maximum RF power
Adjust VR487 for 100% modulation
VR511: RF panel meter adjustment
VR151: S meter adjustment
Connect pin 1 of Q35 to pin 4 of Q35 MSM5907 IC chip
Connect pin 2 of Q35 to pin 4

PALOMAR 4100

Adjust L7, L11, and L12 for maximum power.
Adjust RV2 for 100% modulation.
Adjust RV4 for RF meter adjustment.
Connect pin 9 of IC101 PLL to pin 10 of IC101
for more frequencies.

GENERAL ELECTRIC 3-5821B

Adjust L905, L903, L901 for maximum power.
Adjust VR10 for 100% modulation.
VR11: TX power meter adjustment.
Connect pin 14 of IC801 to 6.44V source
for more frequencies.

JOHNSON MESSENGER 4140/4145

Clip CR12 for 100% modulation.
Adjust T8, L3, L4, and L6 for maximum power.
Connect pin 13 of U101 to 10.30V source for
more frequencies.

SPARKOMATIC SR42/CBM

Cut D107 for 100% modulation.

SEARS 370.38050700

Adjust R218 for 100% modulation.
Adjust T302, T303, and C436 for maximum RF power.

SURVEYOR 2610

Adjust R207 for maximum modulation.
Adjust T204, L202, L205 for maximum power output.
R227: RF panel meter adjustment.
Connect pin 9 of PLL to 4.94V source and connect
pin 9 to 6 for more frequencies.

TRAM D12

Adjust L6 and L3 for maximum power.
Adjust R61 for maximum modulation
R4; RF panel meter adjustment.
Connect pin 7 and 8 of IC10 together for more
frequencies.

Adjust L302 and L306 for maximum RF output

Adjust RV401 for 100% modulation

RV301: RF meter adjustment

Take pin 7 high (4.92V) of IC101

TEABERRY MODEL T COMMAND

Adjust L15, and L12 for maximum RF power

Adjust VR5 for 100% modulation or cut D14

VR6: Modulation meter adjustment

VR4: RF meter adjustment

Connect pin 19 of IC3 to 4.84V source for new frequencies (channels 1-26)

SEARS 562.38200700

Adjust L5, L3, and C301 for maximum AM power

Clip CD11 for 100% modulation

R3: RF power meter adjustment

R121: Alert lamp adjustment

Connect pin 7 of IC10 divider to pin 5 for more frequencies (channels 1-26)

TEABERRY MODEL "T"

Adjust L801, VC901, VC902, L702 for maximum RF power

VR1: S meter adjustment

VR4: Adjust for 100% modulation

VR7B: RF meter adjustment

TEABERRY RACER "T"

Adjust L903 and L905 for maximum AM power

Cut D505 and D504 or adjust VR6 for 100% modulation

VR4: S meter adjustment

VR7: RF meter adjustment

Connect pin 3 to pin 12 of IC802 (M58472P)

TEABERRY "T" DISPATCH

Adjust L13 and L15 for maximum RF power

VR1: S meter adjustment

VR3: Mike gain adjustment

VR6: RF power meter adjustment

Connect pin 19 of IC3 (uPD858) to pin 21 and/or

Connect pin 18 of IC3 to pin 21

UTAC TRX-500

Adjust L15, and L17 for maximum RF power output
Adjust VR7 for 100% modulation
VR8: RF panel meter adjustment
Take pin 10 of IC501 high (4.30V) for more frequencies

ROYCE 604

Adjust VR202 or clip D202 for 100% modulation
Adjust T302 and L303 for maximum power

ROYCE 619

For AM modulation cut out diode 202 located under meter lamp.

ROYCE 1-625

Adjust VR1602 for maximum modulation
Connect pin 6 of PLL to 5.93 volt source;
Connect pin 5 of PLL to 5.93 volt source;
Connect pin 7 of PLL to 5.93 volt source:
For adding more frequencies

ROBYN DG130D

Adjust L13, L12, L11, L10 for maximum power
Adjust VR6 for 100% modulation
VR4: RF power meter adjustment

ROBYN T-240D

Adjust VR4 for 100% modulation
Adjust L801, VC901, VC902, and L702(top)
for maximum power
VR6: RF panel meter adjustment

ROBYN WV110

Adjust L15, L13, L12, L11, and L10 for maximum power
Adjust VR6 for 100% modulation
VR4: RF power meter adjustment

ROBYN SX 401

Adjust L12, L15, L16, L17, and L18 for maximum power.
Adjust VR7 for 100% modulation.
VR3: RF panel meter adjustment.
Connect pin 10 of IC1 to 5.46V and connect
pin 11 of IC1 to 5.46V for adding more frequencies.

ROBYN GT410D

Adjust VR13 and VR12 for maximum modulation.
Connect pin 10 to a switch with the other end
of switch to 5.46V. Connect also pin 11 to
pin 10 for adding more frequencies.

ROBYN SX402D

Adjust L15, L18, L19, L20, and L21 for maximum power.
Adjust VR13 and VR12 for maximum modulation.
Adjust L22 for minimum interference on TV at 54mhz harmonic.
Connect pin 10 of IC1 to 5.46V for new frequencies.

ROYCE 1-621

Adjust L4 for maximum power.
VR3: Adjust for 100% modulation.

REALISTIC TRC424

Adjust L906, L909, and L910 for maximum power.
Adjust VR9 for 100% modulation.
Adjust F901 for minimum interference on TV set at
54mhz harmonic.
Connect pin 6 of IC801 to 5.93V source and connect
pin 5 of IC801 to 5.93V source for more frequencies.

REALISTIC TRC468

Adjust T14 and T15 for maximum power.
Cut D7 for 100% modulation.

ROYCE 604

Tune T302 and L303 for maximum power.
Cut D202 for 100% modulation.

Adjust L34 for maximum power.
 Adjust R116 for 100% modulation.
 Connect pin 5 of IC1 to 4.70V source and connect
 pin 6 of IC1 to 4.70V source for adding more
 frequencies.

COURIER RANGLER 40D

Adjust L119 and L120 for maximum power.
 Adjust VR304 for 100% modulation.
 VR103: RF panel meter adjustment.

COLT 480/1000

Adjust T6, L7, L11, and L13 for maximum power.
 Adjust RV12 for 100% modulation.
 RV11: SSB mike gain adjustment.
 VR4: AM power adjustment.
 RV3: RF power meter adjustment
 RV1: Antenna warning indicator control adjustment

COURIER BLAZER 40D

Adjust T13 and L9 for maximum power adjustment.
 Adjust VR9 for 100% modulation.
 VR6: TX panel meter adjustment.

COBRA 32XLR

Clip CD11 next to 5014 XFMR for 100% modulation.

COBRA 140GTL

VR6: AM power adjustment.
 VR7: SSB power adjustment.

COBRA 21 GTL

Adjust L10 for maximum power.
 Adjust VR5 for 100% modulation.

COBRA 25GTL

Adjust L10 for maximum power.
 Adjust VR5 for 100% modulation.

Adjust T6, L7, L11, and L13 for maximum power.
Adjust RV2 for SSB power.
Adjust VR4 for maximum AM power.
Adjust RV12 for 100% modulation.
Adjust RV11 for SSB mike gain.
RV3: RF panel meter adjustment.

UTAC TRX400

Adjust L14 and L15 for maximum power.
Adjust VR7 for 100% modulation.
Adjust VR8 for RF panel meter adjustment.
Connect pin 10 of IC501 to 4.30V source and
Connect pin 11 of IC501 to 4.30V source for
more frequencies.

HYGAIN VIII

Adjust RV608 for AM power adjustment.
RV7: AM mike gain adjustment
RV8: SSB mike gain adjustment.
RV5: SSB automatic level control
adjustment

SEARS ROADTALKER 40 CM-6000LA

Clip D501 for 100% modulation.

SEARS CM6000LC

Clip D7 for 100% modulation.

Adjust RV2 for 100% modulation.
 Adjust L7, L11, and L12 for maximum AM power.
 RV4: RF panel meter adjustment
 RV3: S meter adjustment
 Connect pin 9 to pin 10 IC1 PLL02A for more frequencies. Also see modification for BOMAN CB930 for more frequencies.

PIERCE SIMPSON SUPERTIGER 40A

Adjust L12, L9, and L6 for maximum RF power.
 VR10: RF meter adjustment
 VR6 : Modulation meter adjustment
 VR7 : S meter adjustment
 Adjust VR13 for 100% modulation.
 Connect pins 10 and 11 of IC1 MM55104N together.
 Connect to pin 1 for more frequencies.

PALOMAR MODEL 49

Adjust L403, L406 for maximum RF power.
 Clip D207 for 100% modulation.
 VR402: RF meter adjustment
 VR401: S meter adjustment
 Connect pin 2 of IC1 MSM5807 to pin 3 for more frequencies.

ROYCE 1-641

Adjust T15, L6, and L1 for maximum RF output.
 Adjust VR7 for 100% modulation.
 VR8: Adjust for maximum SSB power.
 VR9: Adjust for 13.8 volts
 VR4: S meter adjustment

REALISTIC TRC455

Adjust C430, L404, and L403 for maximum RF power.
 Adjust R504 for 100% modulation.
 R404: RF meter adjustment
 R902: SWR meter adjustment
 R160: S meter adjustment
 Connect pin 10 to pin 1 of IC1 SM5104 for adding frequencies.

SBE 45CB TRINIDAD III

Adjust L305, L308, L309 for maximum AM power.
Adjust R226 for 100% modulation.
Adjust R404 for 13.8 volts.
R319: RF meter adjustment
R324: SWR meter adjustment
R128: S meter adjustment

SBE MODEL SBE42CB CORTEZ 40

Adjust L304, L306 for maximum RF power.
Adjust VR203 for 100% modulation.
VR301: RF meter adjustment
VR101: S meter adjustment
Connect pins 8 and 9 together for new frequencies IC401
(SM5107)

SBE 26CB1A

Adjust L6, L*, and L9 for maximum RF output.
Adjust VR9 for 100% modulation.
VR6: RF meter adjustment
VR7: S meter adjustment

SEARS 663.38070700

Adjust VR2 for 100% modulation.
Adjust L15, L12, and L11 for maximum RF output.
VR205: RF meter adjustment
VR204: S meter adjustment
Connect pin 19 of IC3 D858 to pin 21 for more
frequencies.

SEARS 934.38120700

Adjust T703, T704, and T705 for maximum RF power.
Clip D501 for 100% modulation.
RT2: RF meter adjustment
RT1: S meter adjustment

WARDS GEN-775A

Adjust L209, L210, and L211 for maximum RF power.
Adjust VR206 for 100% modulation.
VR205; RF power meter adjustment

ANTENNA
SECRETS

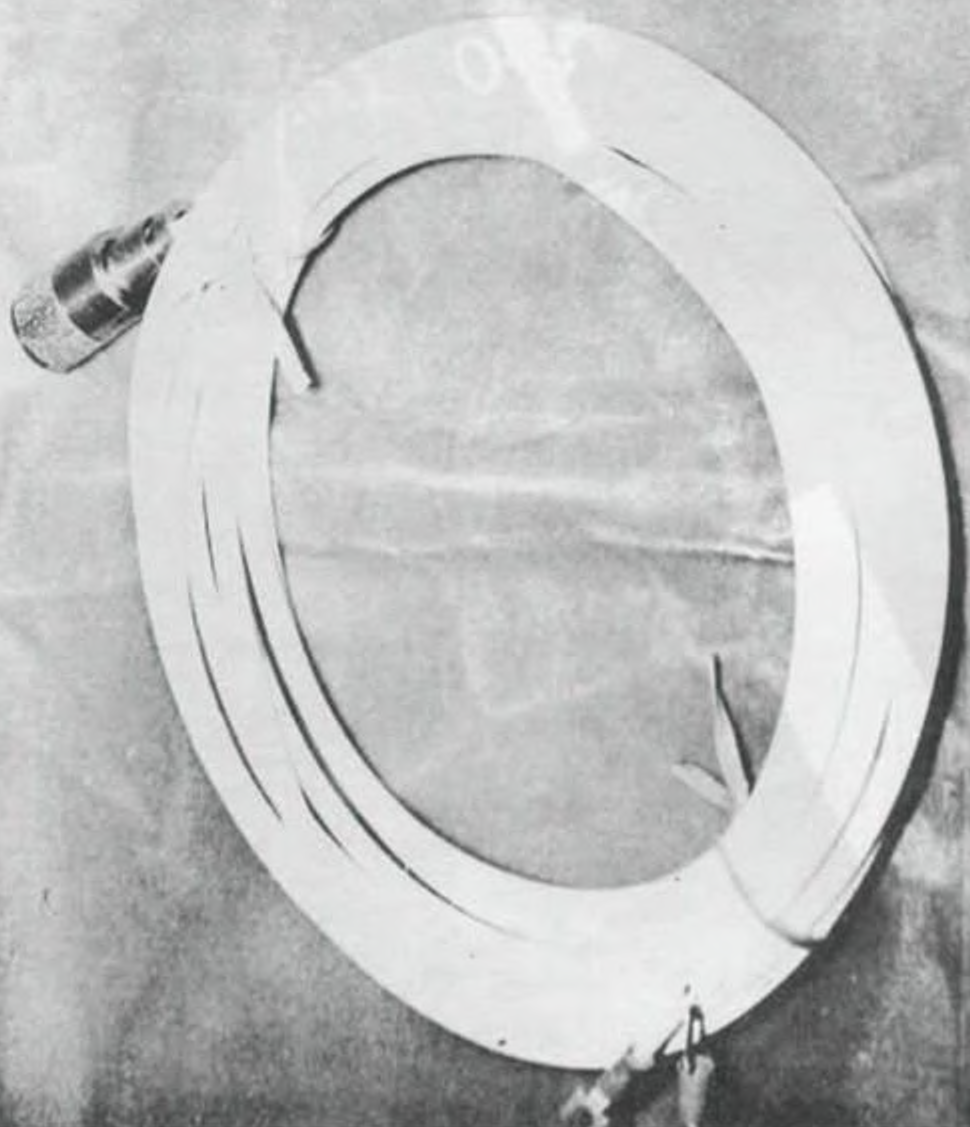

Stainless Steel
Stud Mt. Kit

Fits K-40

(For Big Stick no special coax assembly needed) For mounts with 3/8" existing mounts, use special wiring cable. See drawing 'A' on this page.

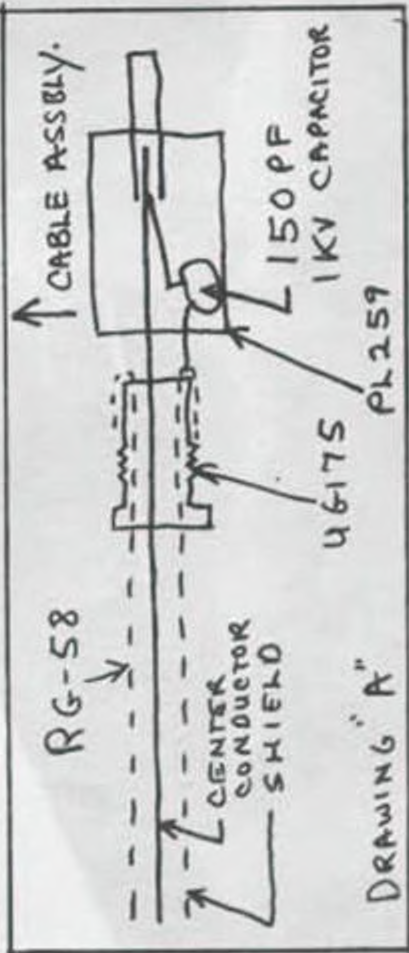



K-40 FEATURED ON TOP OF "BIG STICK"

POWER SUPPLY CIRCUIT FOR 300-400 WATT LINEAR AMP.

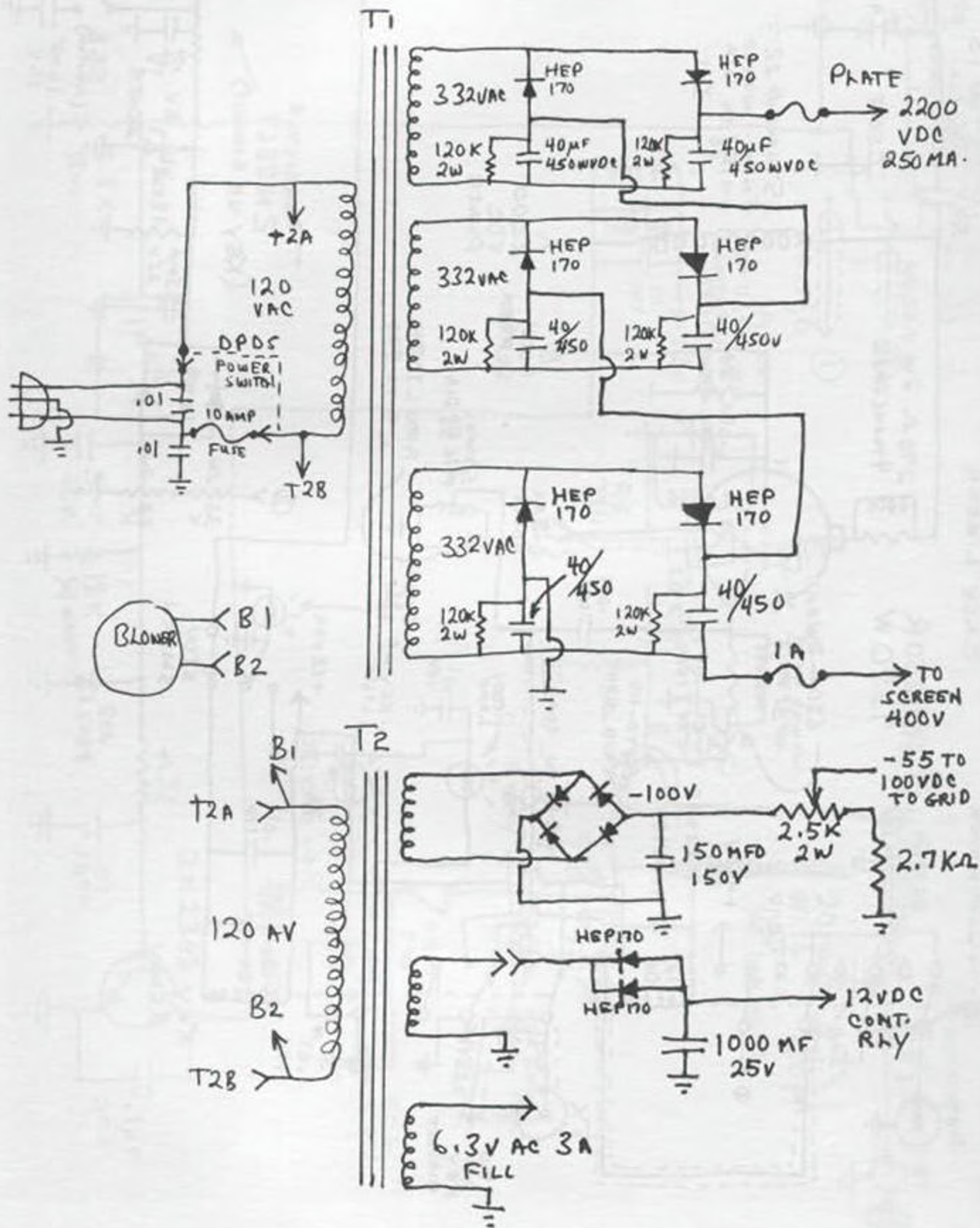

WATTMETER CIRCUIT AND LAY OUT DIAGRAM FOR 300-400 WATT BASE LINEAR

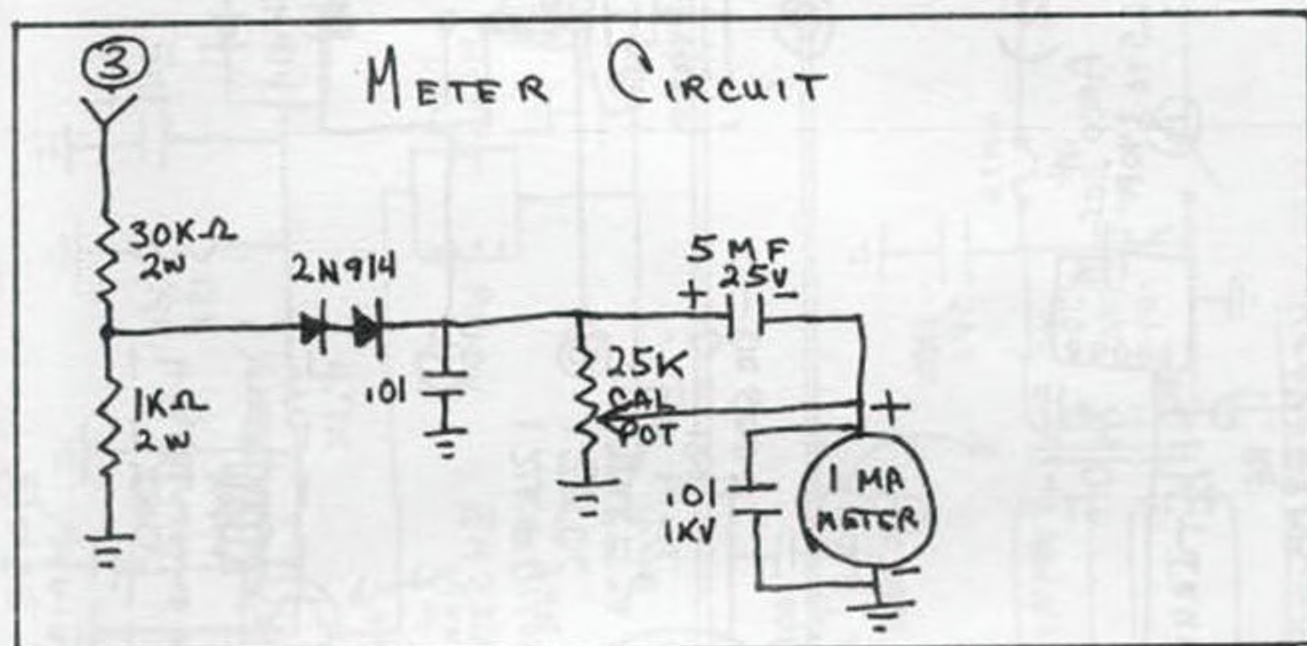

NOTES:

- ① USE CHIMNEY'S AND FORCED AIR BLOWER
- ② BOTTOM OF CHASSIS MUST BE AIR TIGHT SO AIR MUST BE FORCED THROUGH TUBE.
- ③ USE DAYTON BLOWER PART # 4C012 OR EQUIV.

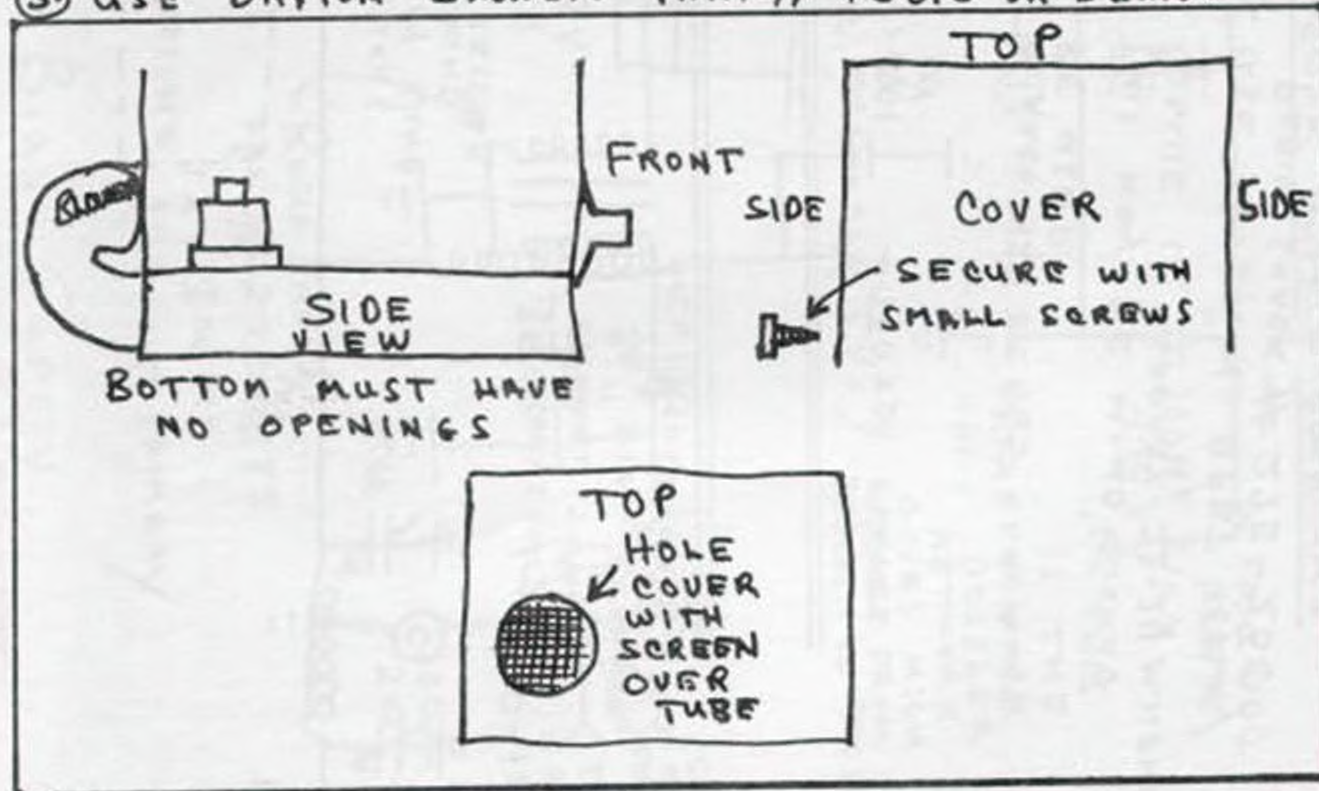

MODIFICATIONS

EAGLE - Model 200

DRIVER MODIFICATION:

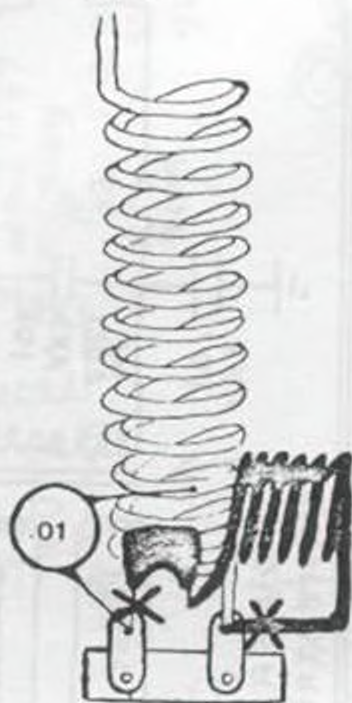

Factory Issue



After Modification

OUTPUT MODIFICATION:

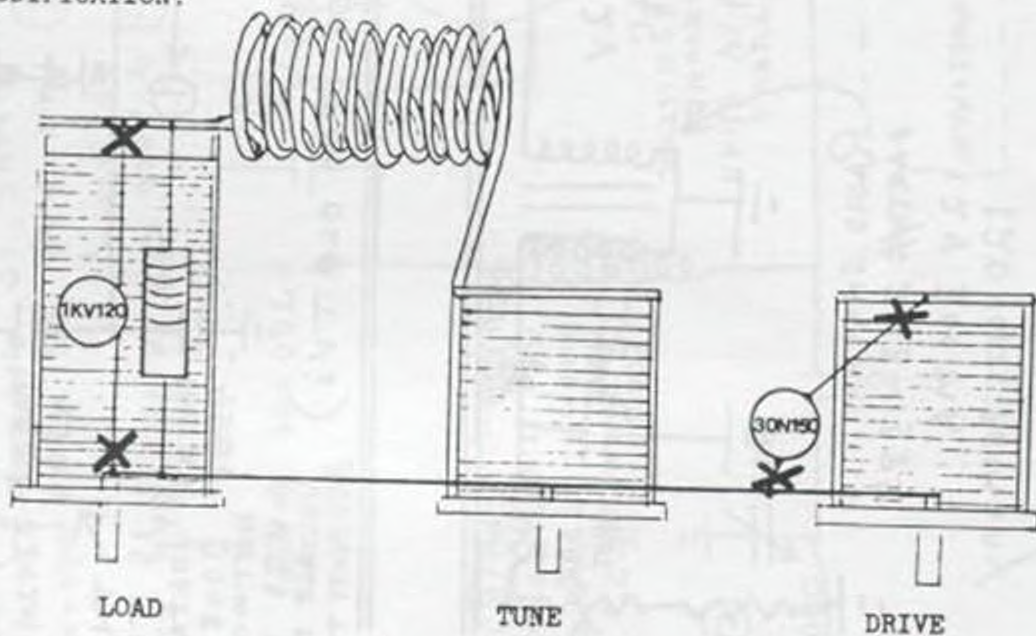

Factory Issue as depicted above. To modify, remove capacitors (1KV120 & 30N150) across "Load" and "Drive" Controls. Cut as indicated by "X's".

DRIVER MODIFICATION:

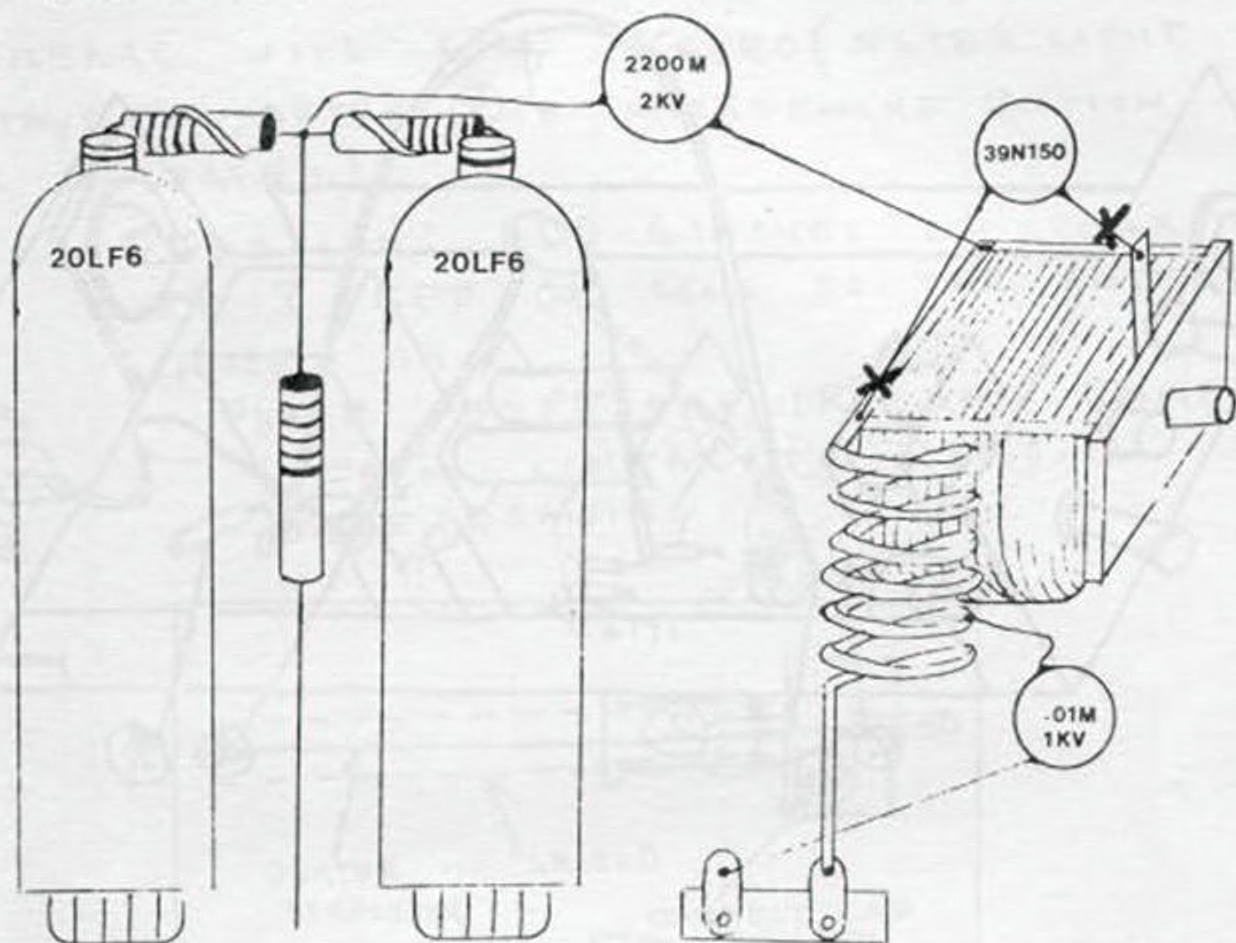

Factory Issue as depicted above. To modify, remove capacitor (39N150) across Drive Control. Cut as indicated by "X's".

OUTPUT MODIFICATION:

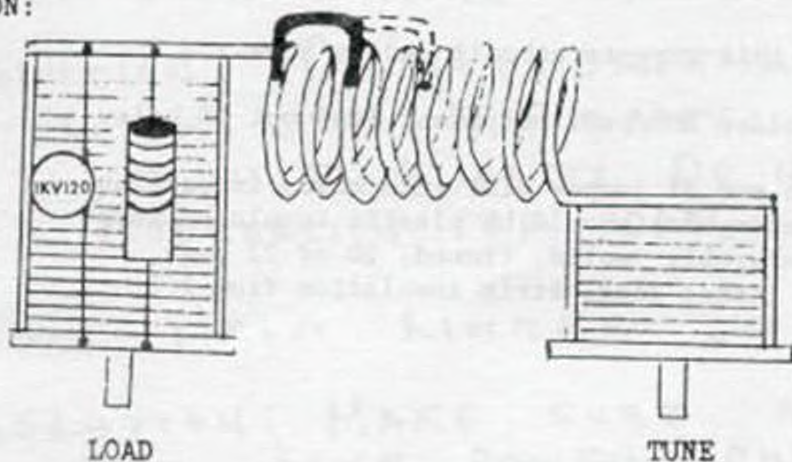

Factory Issue as depicted above. To modify, move strap on coil between "Load" and "Tune" from third turn (as per factory issue) to fifth turn (as indicated above).

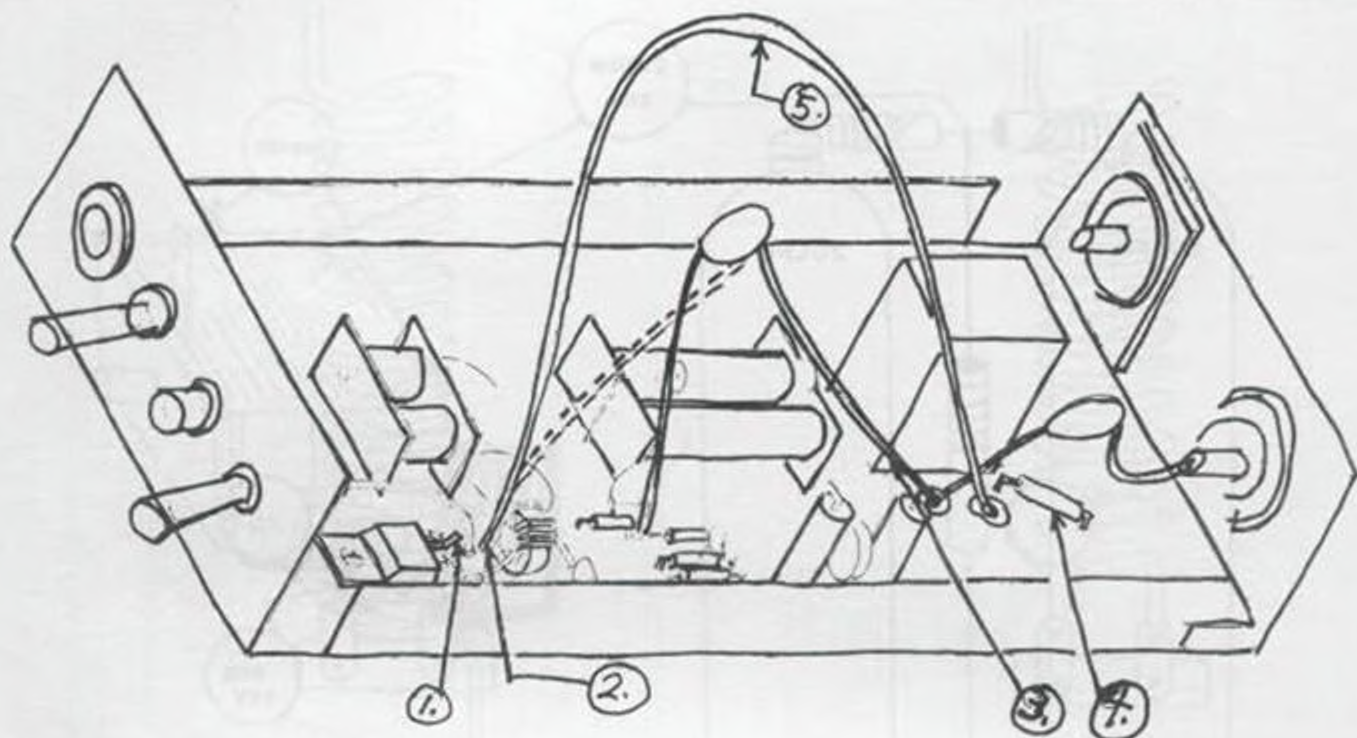

INSTRUCTIONS

- (1) Melt solder and raise center tab out of hole.
- (2) Melt solder and pull wire out of hole then-
- (3) Solder this wire to circuit pad as shown.
- (4) Melt solder and pull component lead out of hole.

Solder each end of jumper wire into holes in pads as shown. Jumper wire should be plastic insulated (such as PVC) preferably solid, tinned, 20 or 22 gage, about five inches long. Strip insulation from 1/8 inch, each end.

LINEAR AMPS PROBLEMS AND SOLUTION

- ① LINEAR WILL NOT UN-KEY. SOLID STATE LINEARS WILL STAY KEYED (METER LIGHT STAYS ON AFTER THE MICROPHONE BUTTON IS RELEASED.)

SOLUTION: ADD 6 INCHES OF COAX TO 3 FEET OF COAX TO THE ANTENNA LINE. OR,
PLACE 150 PF CAP 1KV IN JUMPER FROM LINEAR TO RADIO.
SEE DRAWING.

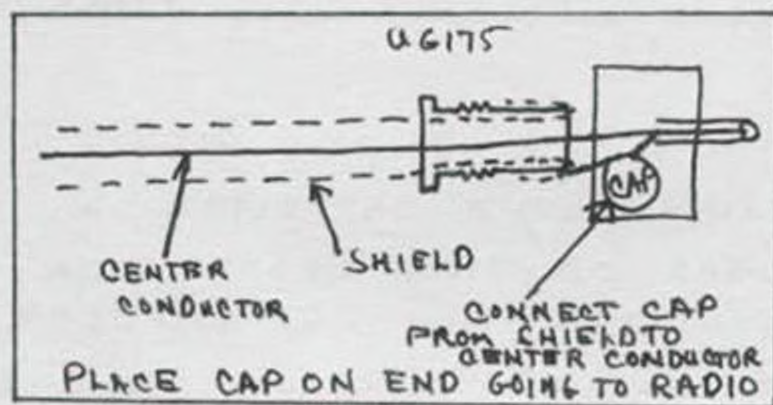

- ② DISTORTION (POOR AUDIO OR MODULATION) IN AM OPERATION. OVER DRIVING.

SOLUTION: DO NOT DRIVE LINEAR WITH OVER 7.5 WATTS OR BETTER YET USE 4 WATTS DO NOT EXCEED MODULATION OF 100%.

- ③ HIGH SWR FROM LINEAR TO ANTENNA.

SOLUTION: MAKE SURE ANTENNA WILL TAKE POWER. CHECK COAX FOR POOR CONNECTIONS.
NOTE: IN CASES WITH K40 RAISE STINGER $\frac{3}{8}$ " OFF BOTTOM OF LOAD.

- ④ TO INCREASE POWER OF LINEAR. (SEE NEXT PAGE.)

LINEAR AMPS PROBLEMS AND SOLUTION (CONTINUED)

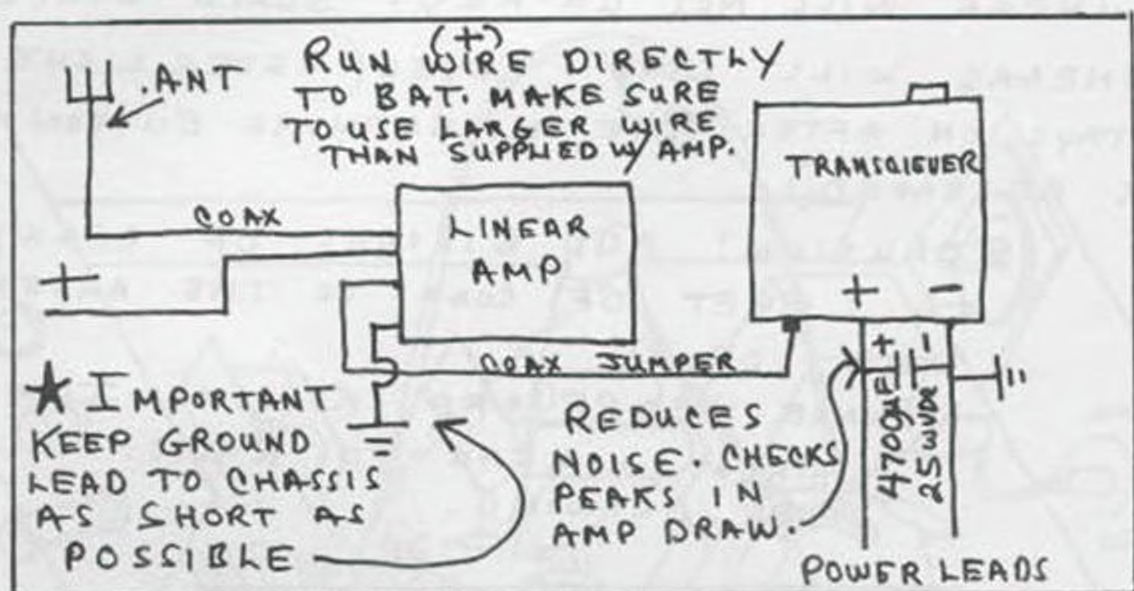

5. NOTE THE 4700µF CAPACITOR IN THE POWER LEAD OF THE TRANSCIEVER. THIS CAPACITOR CAN BE SMALLER. 2000µF IS W/DC. WILL ALSO BE SUFFICIENT.

DUE TO THE INTERNAL RESISTANCE OF SOME MOBILE BATTERIES (ESPECIALLY OLD BATTERIES) THERE MAY BE SOME CURRENT LOSS WHEN PEAKS OF MODULATION ARE INCREASED. THIS CAPACITOR WILL HELP KEEP THIS MORE CONSTANT. IN SOME CASES IT WILL ACTUALLY HELP MODULATION.

IN ANY CASE IT WILL HELP THE NOISE SO YOU MIGHT GIVE IT A TRY.