

SECRET
CB®



CONFIDENTIAL
**FACTUAL
REPORT**
SCHEMATICS ETC.

COPYRIGHTED

PRICE \$20.00 U.S. FUNDS

IMPORTANT: READ THIS FIRST

The information in this book is not to be used to exceed F.C.C. specifications, in any case, as applied to power, modulation, frequency spectrum, etc. It is illegal to do this to any CLASS D RADIO.

This book is a factual report of gathered information, and as such is intended for use on radios for EXPORT ONLY.

If you are not familiar with electronics, it is better to check for advice with your local electronics or CB center, as to restrictions, etc., concerning your radio.

More information, on other units will be forthcoming in future issues.

This book will not be found at a book store, but can be obtained through your local CB Dealer or Distributor, or direct from Selman Enterprises.

Secret CB®
Volume Eighteen
Published March 1984

© Copyright 1984, Selman Enterprises, Inc.

All rights reserved. No part of this book shall be reproduced, stored in a retrieval system, or transmitted by any means, electronic, mechanical, photocopying, recording, or otherwise, without written permission from the publisher. No patent liability is assumed with respect to the use of the information contained herein. While every precaution has been taken in the preparation of this book, the publisher assumes no responsibility for errors or omissions. Neither is any liability assumed for damages resulting from the use of the information contained herein.

PRINTED IN THE UNITED STATES OF AMERICA

New issues quarterly

Address any and all inquiries to:

Selman Enterprises, Inc.
P. O. Box 8189
Corpus Christi, Texas 78412

(512) 853-2935

ACKNOWLEDGEMENTS

SECRET CB WISHES TO GRATEFULLY ACKNOWLEDGE THE FOLLOWING PEOPLE FOR THEIR HELP AND CONTRIBUTIONS TOWARD GETTING VOLUME 18 IN PRINT. THEIR ENCOURAGEMENT AND CONTRIBUTION OF MATERIAL HAS BEEN INVALUABLE.

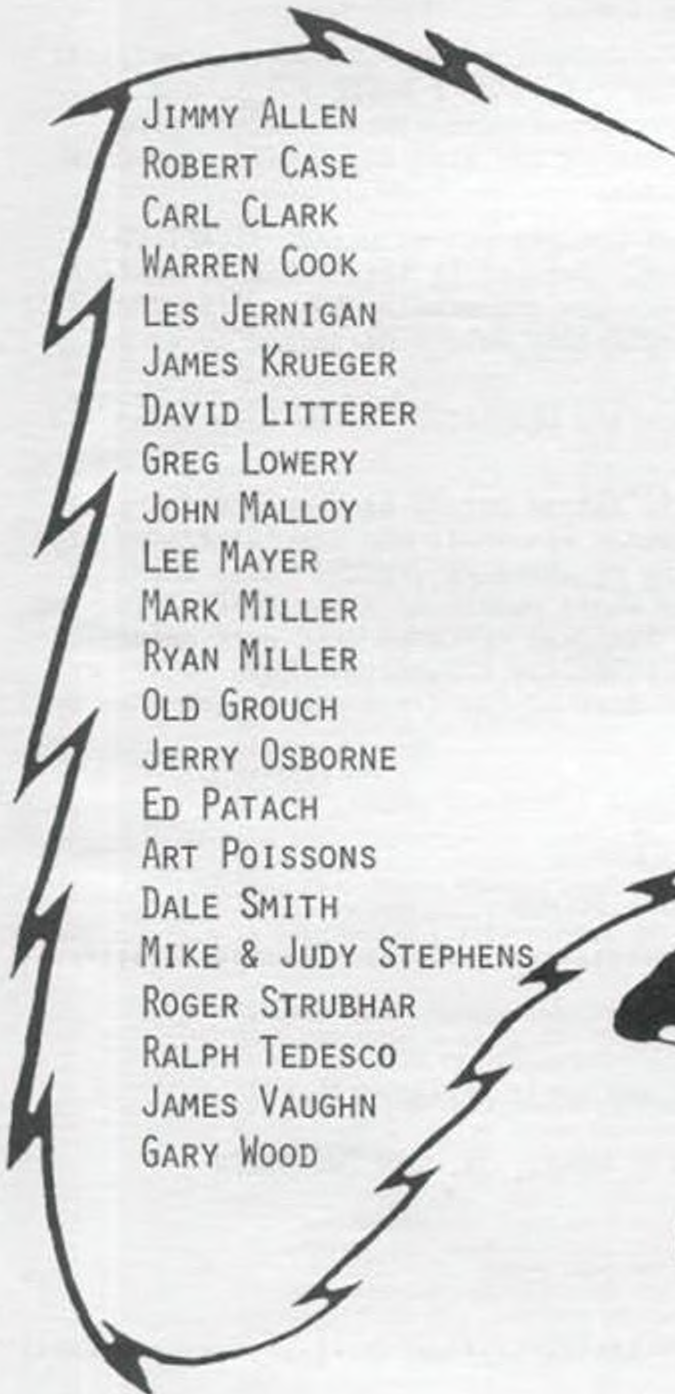

JIMMY ALLEN
ROBERT CASE
CARL CLARK
WARREN COOK
LES JERNIGAN
JAMES KRUEGER
DAVID LITTERER
GREG LOWERY
JOHN MALLOY
LEE MAYER
MARK MILLER
RYAN MILLER
OLD GROUCH
JERRY OSBORNE
ED PATACH
ART POISSONS
DALE SMITH
MIKE & JUDY STEPHENS
ROGER STRUBHAR
RALPH TEDESCO
JAMES VAUGHN
GARY WOOD

WANTED

NEW MODIFICATIONS
NEW CONVERSIONS
TECHNICAL TIPS
PROJECT PLANS
ETC. ETC. ETC.



DORIS SAYS "THANKS" AND A FREE BOOK TO THE ABOVE PEOPLE.

LETTER OF INTRODUCTION AND DEDICATION

Here is SECRET CB Volume 18 in magnificent form due to the diligent work and contributions of WILLIAM G. WENTZ, JR., editor.

Bill covered as many of the FM-DX units as we could find information on. We will continue to search for more on these and the other units. We have requests for more on ham radios, so any information along this line will be appreciated. Also, information needed on new Uniden PC models and all new models coming out. Keep your contributions coming.

Again we are asking for the following information when you send in material for possible print in SECRET CB: MANUFACTURE _____, NAME & MODEL # _____, and PLL CHIP _____. If you have owners and/or service manual please send a clear copy or send the original manual and we will return it the next day. With your tune up requests please send a good clear schematic.

I want to mention that just as SAMS has volumes out of print, SECRET CB will be going the same route sooner or later. Because of references to earlier volumes I am suggesting that you get the ones you are missing NOW, while they are still available. The volumes we are reprinting have a different cover but the contents are the same.

There was not enough interest shown for the NEWSLETTER so we have abandoned the idea.

Seems our crossword puzzle in volume 17 turned out to be a puzzle for sure, because no one has turned in a winning answer. For those who are interested here are two clues: #23 across is two words, one of which is jockey. Also there is a "trick" answer in puzzle. Hint - man who wrote puzzle is a gun collector. Two answers will fit but only one is correct. Deadline extended till next volume. Names of winners will be published, unless otherwise requested. GOOD LUCK! We have a new puzzle, but holding off until we have at least one winner for this one.

Until next volume.....

Always sincerely yours,

Doris

Doris Selman

IT IS WITH SINCERE APPRECIATION AND GREAT PLEASURE THAT I
DEDICATE THIS VOLUME TO WILLIAM G. WENTZ, JR. AND THE OTHER
TWENTY-TWO CONTRIBUTORS.

TABLE OF CONTENTS

	PAGE #
ACKNOWLEDGEMENTS.....	1
INTRODUCTION.....	2
TABLE OF CONTENTS.....	3
SUPER STAR 360 SCHEMATIC.....	4
EXPORT ROUNDUP.....	5-10
EXPORT MISCELLANEOUS INFORMATION..	11-12
COBRA148GTL-DX (Widebanding/VCO Expansion).....	13
MB CHASSIS SERVICE NOTES.....	13
CAUTION - CIRCUITS - QUICKIE.....	14
PACIFIC 800 SSB CLARIFIER MOD.....	15
PACIFIC 800 SSB LOW FREQUENCY MODIFICATION.....	16
YAESU FT-757GX CONTINUOUS TX MODIFICATION.....	16
COBRA 148GTL-DX (MORE): 10KC UP/40 ADDITIONAL CHANNELS UP.....	17
PANASONIC RJ3150.....	18
COLT 355.....	19
SM5104-PLL FREQUENCY MODIFICATION (AM CHASSIS).....	20-21
COBRA 55XLR AM/FM/TAPE/CB FREQUENCY MODIFICATION.....	22
10KC FLIP-FLOP.....	23
148GTL-DX NEW FREQUENCY MODIFICATIONS.....	23
KENWOOD TS-430S MODIFICATIONS.....	24-25
YAESU FT-102 MODIFICATION.....	25
148GTL-DX: EARLY AND LATE UPDATES.....	26
REALISTIC TRC-451 SPECIFIC TUNE-UP.....	26
MOTOROLA CM540-SYSTEM 500/ELECTROSCAN.....	27
SUPERSTAR 2000 FINE TUNE UNLOCK MODIFICATION.....	28
COBRA 148GTL & 2000GTL FINE VOICE LOCK.....	29
PALOMAR 2400 ALIGNMENT	30-33
REALISTIC PRO-22 - SPECIAL NOTES.....	33
SPECIFIC TUNE-UPS: Hygain IV 673, Kraco KB2345, GE 3-5813B...	34
PARTS INFO: LAFAYETTE, COLT, SBE, PALOMAR.....	34
TROUBLE SHOOTING TABLES: Rec86345 PLL SSB CHASSIS.....	34-35
02A 2-BOARD SSB CHASSIS.....	36
858 SSB CHASSIS.....	37
MB8734/MB8719 PLL SSB CHASSIS.....	38
uPC2824/uPC2816 PLL SSB CHASSIS.....	39
COBRA 135XLR (TC5080P Divider-NOT PLL) UPDATE.....	40-41
LINEAR TIPS FOR SQUEAL ON TX.....	41
HINTS/KINKS/GOOPS.....	42
ROBYN OWNERS - PARTS SOURCE & TECH NOTES.....	43
HELP WANTED.....	43
COLT 510 & COMMTRON XII ALIGNMENT.....	44-45
uPD861 PLL AM CHASSIS UPDATE.....	45
CONVERSION CHARTS: WAVELENGTH/FREQUENCY; FREQ. BAND DESIG....	46
MB8719 with 11.1125 crystal (Diagram Layout,w/10KC Flip-Flop).....	47
RADIO SHACK MIKE WIRING.....	48-49
\$\$\$MONEY MAKER\$\$\$.....	50
ANTENNA TUNING; EXCERPTS TO EDITOR.....	51
SPECIFIC TUNE-UPS: MIDLAND 77-806, JC PENNY 681-6241 & 981-8360.	51
HYGAIN HYRANGE V, ROYCE 1-642, COBRA 19XS..	51
KIT #137 INSTALLATION INSTRUCTIONS.....	52-53
LARK FREQUENCY CHART.....	54
SAMS CB/SCANNER MANUALS UPDATE.....	55
PLL02A AM MOD.....	56
\$\$ INDIVIDUAL I.R.A. - TUBES \$\$.....	57
SPECIFIC TUNE-UPS: SEARS 23-934.36740500, KRACO KCB 1401.....	57
SHARP 2460.....	57
"SECRET CB" - OWNER/READER/TECH SURVEY RESULTS.....	58-59
SAVE THE CHIP - MAYBE THE METER.....	60
REMOTE CONTROL OF AMPLIFIER.....	61
THINK SMALL! 1 - 2 - 3.....	62
MIDLAND 79-900 CORRECTION VOL. 5, pg. 47..	62
BASIC - DO & DON'T: VIDEO CASSETTES/MACHINES.....	63
VIDEO "DUBBING/COPYING" TECHNIQUES.....	64
VCR/TV TIPS.....	65
SPECIFIC TUNE-UPS: GE 3-5806, COURIER REBEL 23+, COURIER TRAVELLER II, COURIER CONQUEROR & CARAVELLE, COURIER COMET 23, COURIER CHIEF 23, COURIER CLASSIC II, COURIER CLASSIC III, GREAT GT-838, UNIMETRICS DOLPHONE.....	65 65 65 65
ANTENNA MOUNTING-MOBILE - MY WAY.....	66
SPECIFIC TUNE-UP: OMNIVOX CB-1000.....	66
COBRA 45XLR AM/FM/CB POWER & FREQUENCY MODIFICATION.....	67
PALOMAR SSB 500B TRANSMIT/RECEIVE BROADBANDING.....	67
MB8719 PLL CHASSIS - 5KC DROP.....	68
VOLTAGE REGULATOR DESIGN - USING ZENER DIODE.....	69
ALL ABOUT CRYSTALS.....	70
"SECRET CB" INDEX VOLUMES 1 thru 17.....	71-78
CORRECTIONS: KIT #27A; Vol. 9, pg. 12; Vol. 7, pg. 28.....	79
Vol. 10, pg. 49.....	79
WORKSHEET FORM.....	80

EXPORT ROUNDUP (Cont.)

UNIT	LINE-UP PRINTED	SCHEMATIC PRINTED	OWNER'S MAN. ON FILE.....	VOLUME INDEXED
Ham International Concorde II				
Hygain V (Export)				
NATO 2000, 200 Ch. AM/FM/SSB/CW; and U.K.-FM 26.065-27.855MHz (FM-27.60125-27.99125MHz)				X
Thunder 2000				
Intec 1200FM				
Pacific SSB 800				X
Hygain 8795				
Ham International Concorde				
Jumbo				
Lafayette 1200FM				
Multimode II				
Major 360				
Major M588				
Teaberry Stalker XX (FM), 80 Ch. AM/SSB/FM 26.965-27.855MHz, (MB8719-PLL)				X
Lafayette 2400, 240 Ch. AM/FM/SSB/CW 26.065-28.755MHz, 02A-PLL			- - - Identical to Palomar 2400 - - -	X
Super Star 360, 120 Ch. AM/SSB/CW 26.965-27.405MHz; 28.000-28.940MHz (MB8719-PLL)		V-18	X	X
Super Star 360FM, 120 Ch. AM/FM/SSB/CW 26.965-27.885MHz; 28.500-28.940MHz (MB8719-PLL)				X
Academy 501				
Academy 502				
Amstrad CB900				
Amstrad CB901				
Audioline 340				
Audioline 341				

EXPORT ROUNDUP (Cont.)

UNIT	LINE-UP PRINTED	SCHEMATIC PRINTED	OWNER'S MAN. ON FILE	VOLUME INDEXED
Audioline 345				
Barracuda GT868				
Barracuda HP940				
Binatone 5-Star				
Colt 295				
Cobra 21XFM				
Colt 320DX				
Colt Excalibur				
Commtron CB40F				
Cybernet Beta 1000				
Cybernet Beta 2000				
Cybernet Beta 3000				
Elftone ELCB6000				
Falcon 2000				
Fidelity CB1000M				
Fidelity CB300M				
Fidelity CB2000M				
Fidelity 2001FM				
Great GT858B				
Great GT868B				
Harvard 400M				
Harvard 402MPA				

EXPORT ROUNDUP (Cont.)

UNIT	LINE-UP PRINTED	SCHEMATIC PRINTED	OWNER'S MAN. ON FILE	VOLUME INDEXED
Harvard 420M				
Harvard H401				
Harrier CBX				
Harrier CBHQ				
Halycom Cheetah				
Halycom Condor				
Ham International 840				
Hygain 80				
Hygain 2795				
Hygain 2795DX				
Johnson XK2000				
Lake 850				
Lake 950				
Lafayette HB870AFS				
Maxcom 4E				
Maxcom 6E				
Maxcom 16E				
Maxcom 20E				
Maxcom 21E				
Midland 2001T				
Midland 2001				
Midland 7001(Export)				
Midland 76-200				

EXPORT ROUNDUP (Cont.)

UNIT	LINE-UP PRINTED	SCHEMATIC PRINTED	OWNER'S MAN. ON FILE	VOLUME INDEXED
Midland 3001				
Midland 4001				
Mustang CB1000				
Mustang CB2000				
Mustang CB3001				
Nato 40FM				
Oscar 1				
Petrusse Pacific 160				
Radiomobile 201				
Radiomobile 202				
Rotel RVC220				
Rotel RVC230				
Rotel RVC240				
Sapphire 2000X				
Sirtel Searcher				
Speedway				
Stalker ST-9FDX				
Steepletone SCB1FM				
Tandy TRC-2000				
Tandy TRC-2001				
Tandy TRC-2002				
Tristar 777				
Tristar 797				

EXPORT ROUNDUP (Cont.)

UNIT	LINE-UP PRINTED	SCHEMATIC PRINTED	OWNER'S MAN. ON FILE	VOLUME INDEXED
Transcom CBK2000				
Transcom CHX4000				
Transcom GBX4000				
Uniace 100				
Uniace 200				
York JCP861				
York JCP863				

These tables will give you an idea of what is out there.

Also will show just what schematics/service data is available.

I can't see purchasing anything that doesn't have a schematic in with the Owner's Manual. Just throwing your money away...

If the 'underground distributor' can't provide a schematic and Service Manual/Lineup - let him eat the units, instead of you!

If you possess any Owner's Manuals, Service Manuals, Line-up Procedures, PLEASE send to Doris. It will be returned as soon as possible. NOTE: ORIGINAL NEEDED FOR THE SCHEMATIC!

I quit counting how many units there are when I hit the 100 mark!

LAFAYETTE 1800, 200 channel-AM/FM/SSB/CW; Freq Range: 25.965-28.005MHz.
 Power Specs-MAX: SSB-12W, AM-7.5W, FM-10W, 3-settings
 RF Gain: Local-Mid-DX ?? Cheap route again!
 Fo Selection: -Here's where it shines, a 50-pos switch
 and 4 position band switch. True 10KHz
 skips-no gaps, or jumping around-the only
 exception is Band C, Pos 1-40..(Here every-
 thing is identical to reg. CB Fo's.).
 Clarifier: Split...Coarse adjusts TX/RX, \pm 5KHz.
 Fine adjusts RX ONLY, \pm 800Hz.
 PLL Chip: PLL02A, Pins 8, and 9 (Tied to Logic 1, so
 have a lot to play with, as plenty of ? sw's.)
 ? Switches: NB, ANL, CB/PA
 FINAL NOTE: El-Cheapo Final again, no SWR Mtr.
 Class shows in the 50-pos switch only with
 10KHz spacing!

(*) SUPER STAR 2000, 200 channel-AM/FM/SSB/CW; Freq Range: 26.065-28.305MHz
 Identical to above unit in all dimensions, with the
 following exceptions: 40-pos 'CB' switch, and 5-pos
 band switch; also different Fo range.

(*) SUPER STAR 2000, 200 channel-AM/FM/SSB/CW; Freq Range: 25.965-28.005MHz.
EXACTLY IDENTICAL TO THE LAFAYETTE 1800

(*)- TWO (2) different versions of this same radio exist, check first!!!

LAFAYETTE 2400FM (2400), 240 channel-AM/FM/SSB/CW; Freq Range: 26.065-
 28.755MHz.
 --- ALL SPECS IDENTICAL TO PALOMAR 2400 --- (Vol. 17)

TEAHERRY STALKER XX (FM), 80 channel, AM/FM/SSB; Freq Range: 26.965-
-Base Station- 27.885MHz. (CAUTION, as these have 220V transformers
 and power cords/plugs; you will have to change yourself;
 if not changed by the distributor!) Dealer price is
 running \$275-350 wholesale! MB8719-PLL chip, so plenty
 to play with. I counted 20 different function switches/
 buttons on front of unit-has a SWR meter and clock.
 Lo/Hi frequency switching is done by crystal switching.
 Use Pres. Madison skem. for service work on main board.

NATO 2000, 200 channel AM/FM/SSB/CW - U.K.-FM; 'with the Roger Beep'.
 O.K., this is the one that everyone is asking about-
 Particulars: 40 ch select/5 band switch (A-D, and FM);
 bands A-D are 26.065-27.855MHz in AM/FM/SSB/CW modes
 with usuall jumps/misses on 40 ch. 'CB' selector.
 When band switch is moved to FM you have 27.60125-
 27.99125MHz in 10KHz increments (No jumps-skips).
 RF power, RF gain, is controlled by switches again
 like most similar units. Clarifier is Coarse/Fine
 also. (Complete Owner's Manual wasn't provided nor
 was the schematic, so let me know if I was wrong on
 above).

EXPORTS (Cont.)

SUPER STAR 360, 120 channel AM/SSB/CW; This unit has 2 different frequency bands: 26.965-27.405MHz and 28.000-28.940MHz. PLL chip is MB8719; so no big problem getting the missing portion of the bands; as plenty of idiot switches on front. "A definite plus is SWR meter, RF gain pot., and bias is adjustable on both driver and final" But has the Bird Final-cheep! Split Clarifier. (Note-If anyone comes up with Factory Service Manual on this unit, have need of it already for proposed 360 channel mod.!) RF power specs: 12W-SSB, 5W-AM.

SUPER STAR 360FM, 120 channel AM/FM/SSB/CW; This unit has 2 different frequency bands: 26.965-27.855MHz and 28.500-28.940MHz (No definite PLL chip information or other specs, as no Owner's Manual or schematic provided-NEED. Suspect is similar to above Mil. 360 internally with FM Kit, and crystals changed only.

COBRA 148GTL-B, 60 channel AM/SSB is what is advertised! But the Fo data sheet received shows 120 channels? (Anyone knowing for sure; would appreciate knowing what gives; send the complete Owner's Manual!) Frequency range of the 60-ch unit: 26.965-27.605MHz. 120-ch unit: 26.315-27.605MHz. Schematic and Clarifier mods. have been printed in SCB. *One special note on this unit is that it has a 60 ch. selector switch. No jumping around on ch's 23-25 straight progression in frequency. PLUS for this unit is the SWR Meter, and the capability of additional Fo's up to 28.245MHz with no hassle (Re: Vol 17).

HOT! There is supposed to be a hand-held SSB unit coming into the U.S. from ??? Have been promised a peek at it as soon as it gets IN. If it materializes will have the full story on it for Vol. 19.

Now, to the unit everyone is driving Doris crazy about, calling day and night. The Cobra 2000GTL-DX SE LIMITED ? ? I have been told by trusted individuals that no such unit exists! Even went so far as to write letter to Corporate President of Dynascan Corporation; which has been unanswered as of Feb. 19, '84. DOUBLE-CHECK YOUR SOURCES...

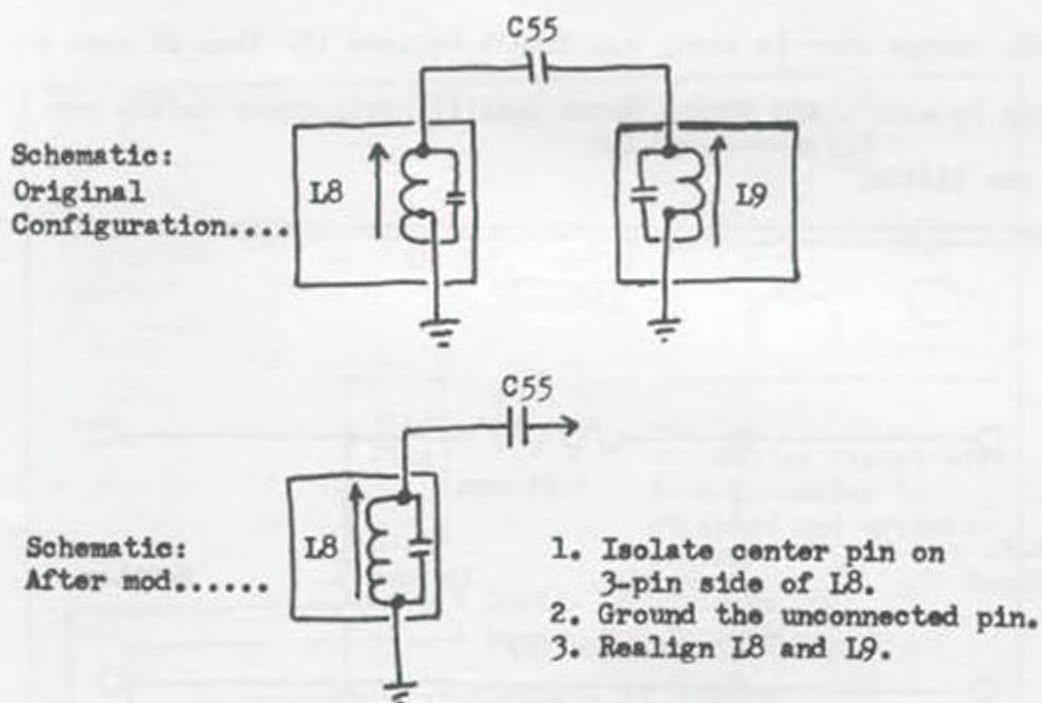
Receive WidebandingVCO Expansion

Simple: Replace R-136 (1M ohm), with a 10M ohm $\frac{1}{4}$ W 5%...

MB CHASSIS - SERVICE NOTES

1. Voltage Regulator (usually numbered IC-5; MB3756) going bad?
Especially in mobile units...

Recommended additional parts should be added to circuitry as shown:
Zener Diode and rectifier diode.....

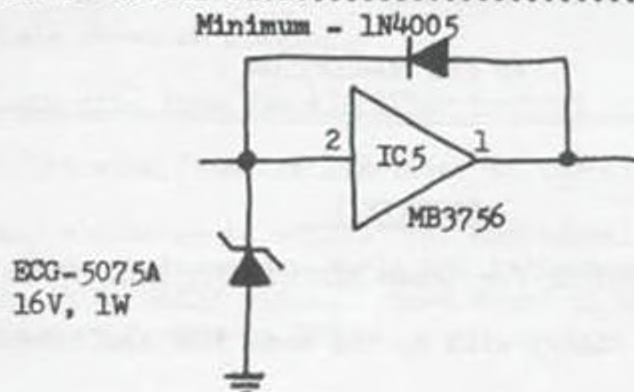

CAUTION - WATCH OUT

I didn't believe it but - it's true, the MB chassis does have a new production run with the uPD2824 PLL Chip on board! I guess 'Big Brother' is clamping down... I was told that the Cobra 142GTL had chip change over in some; but didn't believe it; then in came a unit for Fo mod. - SHO NUFF! Watch Out!!!! Pull cover before you spend the \$\$\$\$\$\$.

CIRCUITS

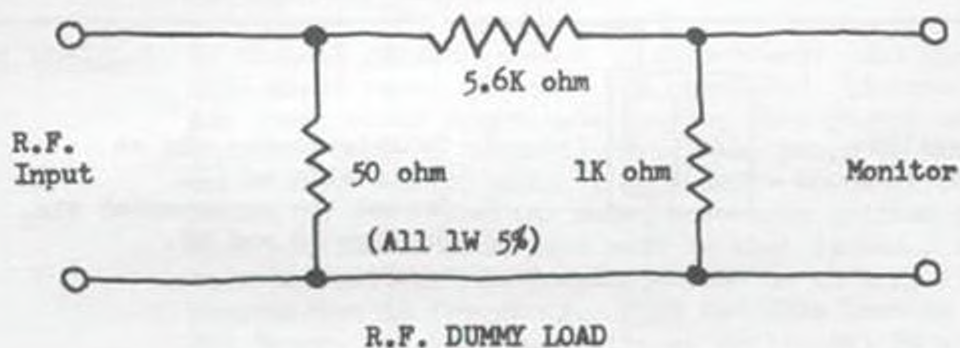

Build above circuit in Aluminum Mini-box for shielding.

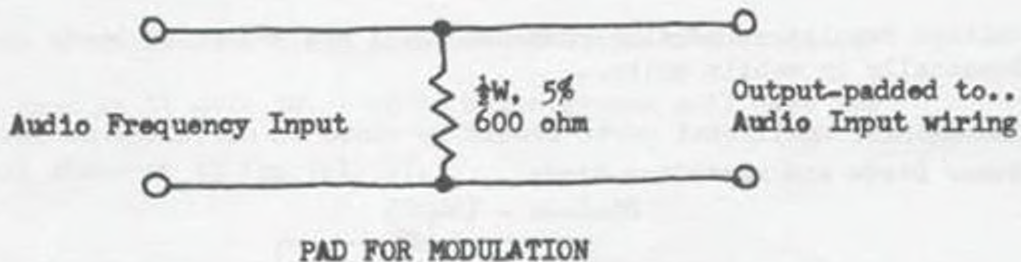

QUICKIE 1

HARD TO FIND: 2SA1012 for those EXPORTS.... ECG-378 is the equivalent; but 2SA473 will do the same job; and cheaper!

CLARIFIER MODIFICATION

by J.O.

"This is an exceptional radio for the money!" SCB NEEDS: Schematic, Owner's Manual, Service Data - anything....

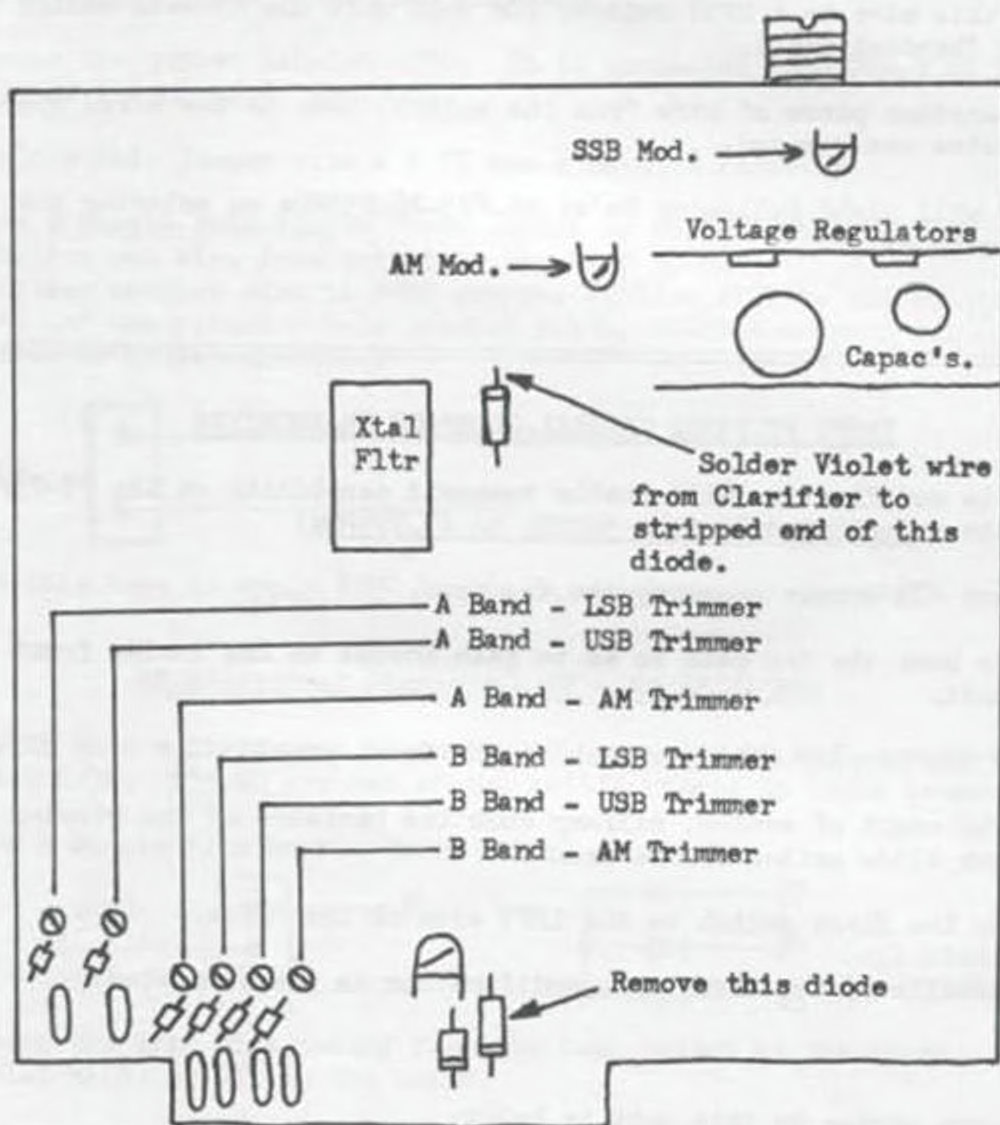

1. Remove resistor on back of clarifier control.
2. Remove the diode shown on drawing.
3. Solder the Black wire from the clarifier control to DC ground.
4. Solder the Violet wire from the clarifier to the diode as shown, +8VDC.
5. Unit should now slide; -4 to +2KHz. For additional slide lift the banded end of diodes between the Xtals and trimmer-add 5.6mH choke in series...Yields -8 to +6KHz slide. Have found it best to do only on the AM, as gets very touchy on SSB.

LOW FREQUENCY MODIFICATION

1. Remove the Blue wire from the top of the board that is attached to the side of the channel selector.
2. Run this wire to a SPST switch. (In this unit the RF Gain switch was used, after 'hard-wiring').
3. Run another piece of wire from the switch, back to the board where the Blue wire was removed.
4. This will yield following Fo's: 26.695-26.955MHz on selector positions 4 through 27.

ENJOY....

YAESU FT-757GX GENERAL COVERAGE TRANSCEIVER

This modification will enable transmit capability on the FT-757GX transceiver continuously from 500KHz to 29,999MHz!

1. Remove all screws securing the top case.
2. Slide back the top case so as to gain access to the inside front of the unit.
3. Note the Display Unit just behind the front panel.
4. To the right of center, halfway down the backside of the Display Unit a Black slide switch can be seen.
5. Slide the Black switch to the LEFT side of the radio.
6. Reinstall the top cover, - - modification is now completed!

Microphone wiring to this unit is below:

SHURE 444: White-6, Shield-7, Black-8.

SHURE 444D: Red-6, Black/Shield-7,
White-8.

ASTATIC D104 (6-wire): Red-6,
Blue/Shield-7, White-8.

ASTATIC 1104C (6-wire): Red-6,
Blue/Shield-7, White-8.

SHURE 526T: Red-6, Black/Shield-7,
White-8.

10KC Switch

This 10KC switch is unique in that it causes all the frequencies to go up 10KC's. ALL BANDS, ALL CHANNELS....

1. Locate the jumper labeled JP54. It is connected from Pin 9 of IC-6 to board ground (D.C. gnd.)...
2. Replace this jumper with a 4.7K ohm $\frac{1}{2}$ watt 5% resistor.
3. Wire a Single Pole Single Throw switch as follows/shown.
 - A. Solder one wire from switch to Pin 9 of IC-6.
 - B. Solder another wire to 8VDC source. (follow JP57 to the outside end and use resistor hole labeled R-146, CAUTION-measure voltage first to double-check!...

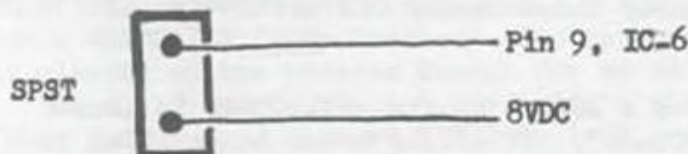

What this does is apply 8VDC to Pin 9, which causes the shift.

40 Additional Channels - UP - to 28,245MHz

With this modification the unit will go up to 28.245 on selector position 1-34. (35-40 are out of the unit's range, in 25MHz range.)

1. Wire a Single Pole Double Throw switch as shown.



2. Remove the Gray wire coming from the band switch at the board, labeled MX(3) or HI, on the board.
 3. Connect this wire to Wire #1 on the switch you just wired up.
 4. Connect wire #2 to the hole labeled MX(3) or HI, vacated by the Gray wire removed in Step 2.
 - * 5. Connect wire #3 to Pin 2 of IC-7.
 - * 6. Connect wire #4 to Pin 15 of IC-6.
 - * 7. Connect wire #5 to Pin 4 of IC-6.
- (* CAUTION: Pay attention to layout of IC-6 and IC-7; pins are opposite of one another and easy to get confused.....

PANASONIC RJ3150

26.325-26.955MHz Modification

Follow steps below exactly! (*)-See drawing for amplification....

1. Change X2 to a 28.875MHz crystal.
2. Change X3 to a 18.18MHz crystal.
3. Change D10 to a 'Super Diode', this will increase the VCO's range.
- * 4. Cut run between pin 10 and the channel selector.
- * 5. Bridge cut with 1K $\frac{1}{4}$ watt 5% resistor.
- * 6. Isolate Pin 9 completely from the 5VDC buss line, don't forget to install the jumper.
- * 7. Wire up the Double Pole-Double Throw-Center Off switch exactly as shown.

CAUTION: Some units might have a squeal on transmit; this is caused by changing D10 to a 'Super Diode'. If adding a lpf in parallel to the diode doesn't cure the problem; you will have to go back to the original varactor; and settle for less bandwidth!

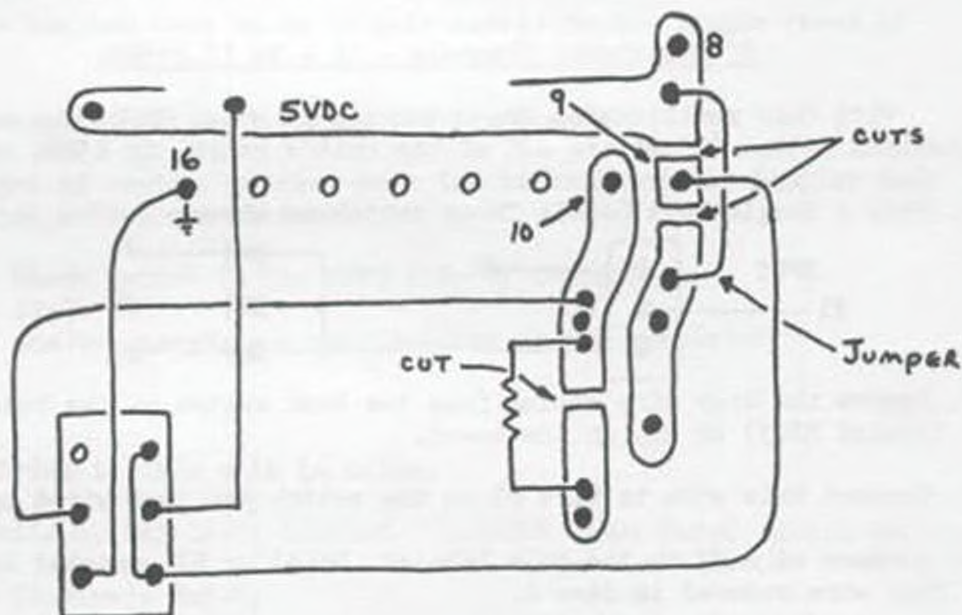

If switch is wired exactly as shown will have the following:

- Switch DOWN: Selector Position 1-40; 26.325 - 26.765MHz
Switch UP: Selector Position 1-27; 26.645 - 26.955MHz
Switch CENTER: Normal Operation..

Have been wanting to get a look at one of these since I saw the picture of it being held in one hand (palm). Well, that was a bigger hand than mine! But is still the perfect little AM rig for all those small cars with no room - after a few adjustments!

Obtained this one direct from the Factory. (Had to pay for it; so don't owe any favors; and still wouldn't lie about it - a buck is a buck!) Checked it over to see if had been set-up at the factory prior to shipping. The person who puts the screws in case, means for them to stay!

Out-of-box performance; RF Power was: Ch 1 - 3.4W, Ch 20 - 3.5W, Ch 40 - 3.6W; with modulation at 40% maximum just talking into microphone. One nice thing is that the Owner's Manual contains: Schematic, PCB Layout, 'Line-up Procedure', Block Diagram, and VCO/Mixer Fo's.

Modulation and RF adjustments are no problem. Turn RV201-max CW, for 85% + modulation (Don't defeat); adjust L205, L206, L207 for peak power at ch. 20, will bring up to about 4.6W across band. Don't change the Final to 2SC1307 as the present final in unit is rated at 20W.

Receive is another story, too noisy for me. Changed C125 to a 3.3Mfd/50VDC electrolytic (+ to gnd.), this got rid of a lot. I also added a 40MFD/25V 'NONpolarized' electrolytic across the speaker terminals. This cleared up the receive enough for my use. (Grandma's, excuse me!)

But still had to fix the idiot light circuit, as no control over on Tx when peaked up - changed RV202 to 100K.. Adjust for 2 lights on when dead keying, 3 lights on when talking into mike, and this way will let you know that something is wrong with antenna system-is all 4 lights come on when transmitting!

For those that don't have the Owner's Manual have put adjustments below as the RV's are under the pots??

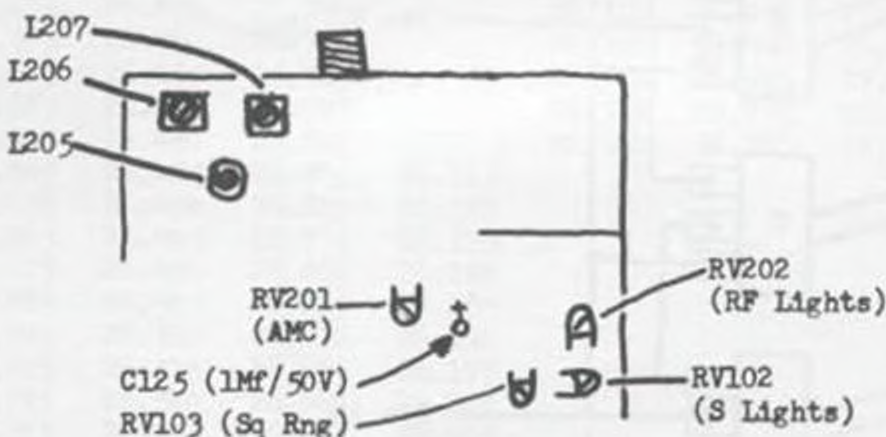

OVERALL: After some 'slight', touch-up hard to beat for the price!

SPECIAL NOTE: Vol. 17, pg. 6-7 of SCB; featured the 'B' Kit by Card Kit Electronics... additional coverage from 26.510 to 26.950KHz, and 5KHz offset. 5KHz Offset will be no problem, if the Ch 9 sw. is utilized, but have a shoehorn ready for the rest. Dimensions on outside of this unit are 4.6" wide, 6.3" deep, and 1.4" high!

Have had 4 offers to buy this unit from me already due to its size and performance.

SM5104-PLL FREQUENCY MODIFICATION (AM CHASSIS)

This modification is for the SM5104 AM Chassis. Units most commonly found are the Courier: Caravelle 40D, Conqueror 40D, FanFare 880DF.

The chip has more coverage than the unit can utilize; 24.775 to 28.355MHz in these chassis - but realignment of the PLL circuitry is necessary for extended coverage.

Switching arrangement below and chart is for a 'stock' VCO in a Courier Caravelle 40D.. as this unit only covered from 26.165 to 27.825MHz.

Consult SAMS 157, pg. 56 for normal pin conditions - and mount all switches so that when in down position, the unit is regular 40 ch 'C.B.'...

Switch wiring is below, all are Single Pole, Double Throw.

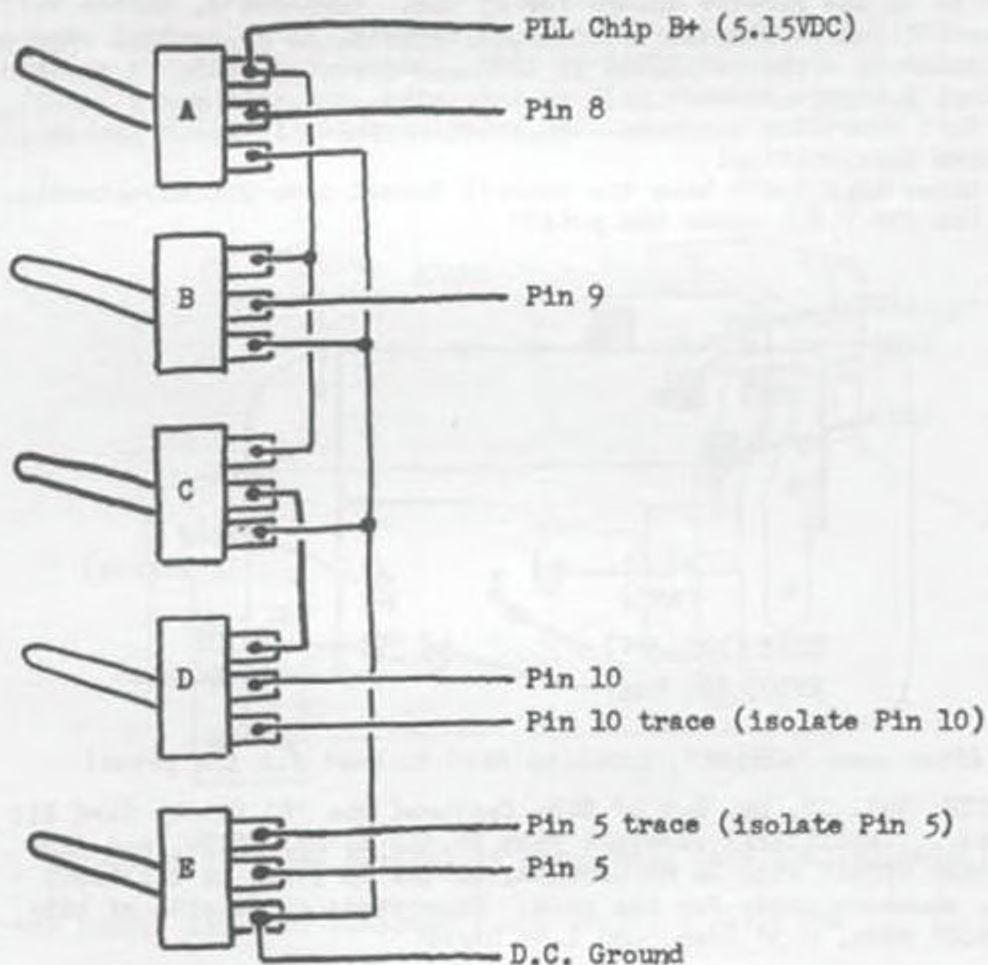

SM5104-PLL Fo. Mod. (Cont.)

If you have mounted the sw's correctly all down should be normal Fo's...

Following chart is what you will get with sw/sws in the up position...

Selector	A-B	E	B-E	A-B-E	ALL	B-C-D-E	C-D	C-D-E
1	26.325	26.325	26.645		26.165	26.805	27.285	26.485
2	26.335	26.330	26.650		26.170	26.810	27.295	26.490
3	26.345	26.335	26.655		26.175	26.815	27.305	26.495
4	26.365	26.345	26.665		26.185	26.825	27.325	26.505
5	26.375	26.350	26.670		26.190	26.830	27.335	26.510
6	26.385	26.355	26.675		26.195	26.835	27.345	26.515
7	26.395	26.360	26.680		26.200	26.840	27.355	26.520
8	26.415	26.370	26.690		26.210	26.850	27.375	26.530
9	26.425	26.375	26.695		26.215	26.855	27.385	26.535
10	26.435	26.380	26.700		26.220	26.860	27.395	26.540
11	26.445	26.385	26.705		26.225	26.865	27.405	26.545
12	26.465	26.395	26.715		26.235	26.875	27.425	26.555
13	26.475	26.400	26.720		26.240	26.880	27.435	26.560
14	26.485	26.405	26.725		26.245	26.885	27.445	26.565
15	26.495	26.410	26.730		26.250	26.890	27.455	26.570
16	26.515	26.420	26.740		26.260	26.900	27.475	26.580
17	26.525	26.425	26.745		26.265	26.905	27.485	26.585
18	26.535	26.430	26.750		26.270	26.910	27.495	26.590
19	26.545	26.435	26.755		26.275	26.915	27.505	26.595
20	26.565	26.445	26.765		26.285	26.925	27.525	26.605
21	26.575	26.450	26.770		26.290	26.930	27.535	26.610
22	26.585	26.455	26.775		26.295	26.935	27.545	26.615
23	26.615	26.470	26.790		26.310	26.950	27.575	26.630
24	26.595	26.460	26.780		26.300	26.940	27.555	26.620
25	26.605	26.465	26.785		26.305	26.945	27.565	26.625
26	26.625	26.475	26.795		26.315	26.955	27.585	26.635
27	26.635	26.480	26.800		26.320	26.960	27.595	26.640
28	26.645	26.485	26.805	26.165				
29	26.655	26.490	26.810	26.170				
30	26.665	26.495	26.815	26.175				
31	26.675	26.500	26.820	26.180				
32	26.685	26.505	26.825	26.185				
33	26.695	26.510	26.830	26.190				
34	26.705	26.515	26.835	26.195				
35	26.715	26.520	26.840	26.200				
36	26.725	26.525	26.845	26.205				
37	26.735	26.530	26.850	26.210				
38	26.745	26.535	26.855	26.215				
39	26.755	26.540	26.860	26.220				
40	26.765	26.545	26.865	26.225				

Switch B: Selector 1-19, will give 27.605 to 27.825MHz.

VCO unlocks below 26.165 and above 27.825MHz. Other positions not marked are repeats...

COBRA 55XLR AM/FM/TAPE/CB, Indash
Frequency Modification

This modification will allow frequency coverage between 26.515 and 27.725MHz. It is advised you obtain the SAMS on this unit for VCO alignment, as will be necessary to do a realignment.

Wire up the two SPDT CENTER-OFF sw's as shown, and isolate/bridge pins 10 and 11 of the PLL chip (MB8719), with 5.1K resistors.

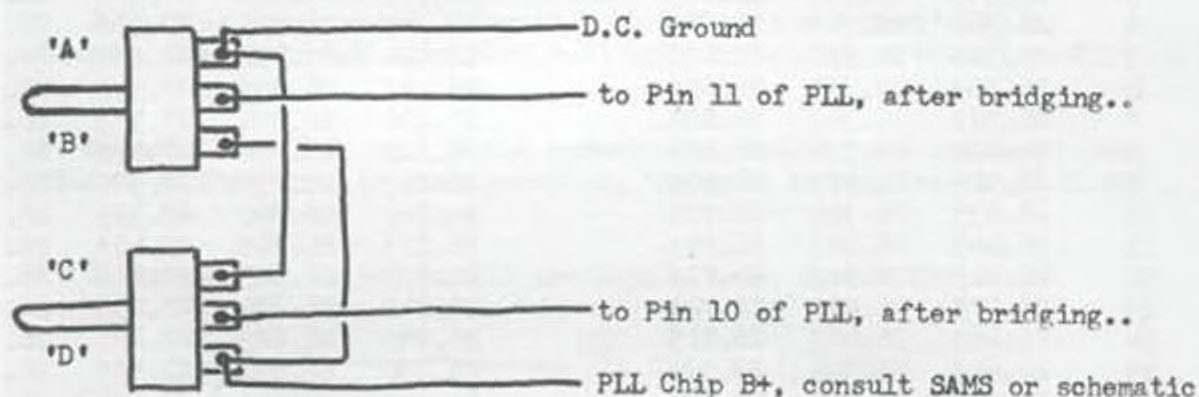

Both sw's in OFF position, normal 40 ch. operation..

Follow charts below for additional Fo's/selector; and switch positions:

<u>'D'</u>	<u>'A' & 'D'</u>	<u>'B'</u>
16 - 26.515	12 - 26.785	16 - 27.475
17 - 26.525	13 - 26.795	17 - 27.485
18 - 26.535	14 - 26.805	18 - 27.495
19 - 26.545	15 - 26.815	19 - 27.505
20 - 26.565	<u>'B' & 'D'</u>	20 - 27.525
21 - 26.575	16 - 26.835	21 - 27.535
22 - 26.585	17 - 26.845	22 - 27.545
24 - 26.595	18 - 26.855	24 - 27.555
25 - 26.605	19 - 26.865	25 - 27.565
23 - 26.615	20 - 26.885	23 - 27.575
26 - 26.625	21 - 26.895	26 - 27.585
27 - 26.635	22 - 26.905	27 - 27.595
28 - 26.645	24 - 26.915	28 - 27.605
29 - 26.655	25 - 26.925	29 - 27.615
30 - 26.665	23 - 26.935	30 - 27.625
31 - 26.675	26 - 26.945	31 - 27.635
32 - 26.685	27 - 26.955	32 - 27.645
33 - 26.695	(Normal Fo's)	33 - 27.655
34 - 26.705	(on ch 1-40.)	34 - 27.665
35 - 26.715	<u>'A' or 'C'</u>	35 - 27.675
36 - 26.725	12 - 27.425	36 - 27.685
37 - 26.735	13 - 27.435	37 - 27.695
38 - 26.745	14 - 27.445	38 - 27.705
39 - 26.755	15 - 27.455	39 - 27.715
40 - 26.765		40 - 27.725

('B' and 'C'; will give 27.745-27.775; on selector pos. 12-15.)

10KC FLIP-FLOP

Conversion
Vol 19
Page 54

Chasing those missing 10KC gaps in some units? This is how to get them.. (Can be used on any PLL, IF NOT A R.O.M. TYPE.).....

.....This switches the LSB to enable you to pick up the skipped code.

Diagram below is for the MB8719PLL chip but will work on any.

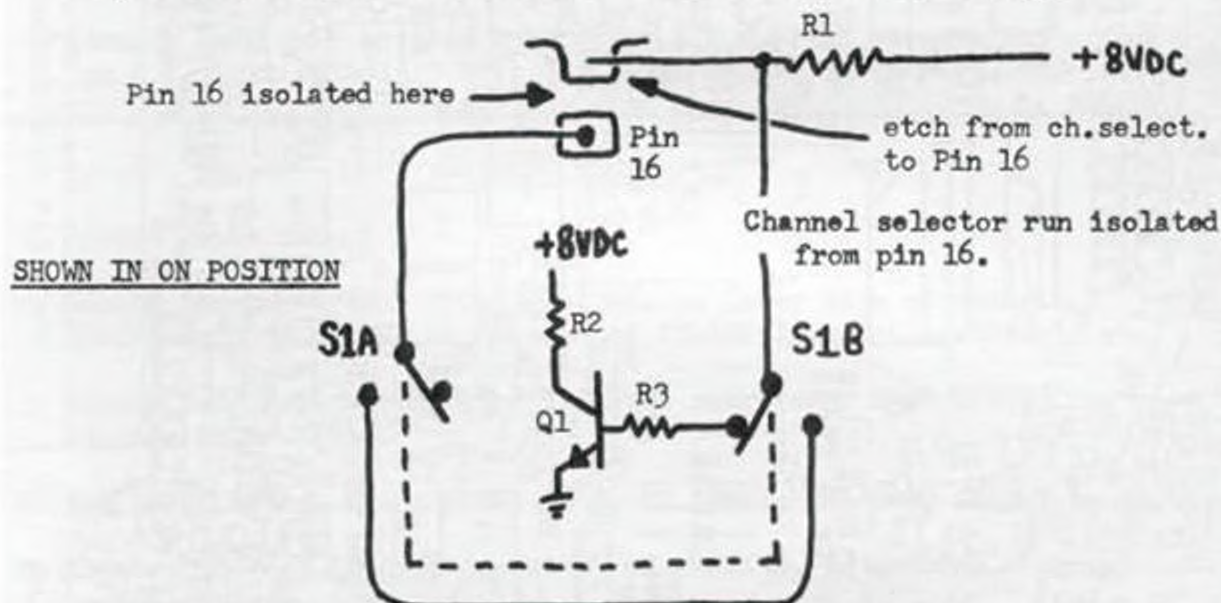

Parts: all resistors are 10K for MB8719, 5K for an 858 at 5V logic.
Q1 is either a 2N3904 or 2N2222.
Switch is DPDT.

148GTL-DX New Frequency Modifications

Here are additional Fo Mods, actually the easiest ones yet.

Instead of using 2 switches to open Pins 11 and 12 of IC-5; as in Vol. 15 page 22; to obtain extra frequencies:

Try the following by opening up the trace to Pin 2 of IC-7.

Will give the following with pin 2 open:

Bandswitch Low : 25.875 - 26.315MHz
Mid : 26.325 - 26.765MHz
High: No change

Also try setting the CH-9 switch to the mid-position for higher frequencies, (27.895). Have no further info on this-but easier to open the off pos of switch, and then close the off pos by eliminating wire at the switch-simple!

TS-430S PC BOARD VIEW

RF UNIT (X44-1510-11) Component side view

2-15-84

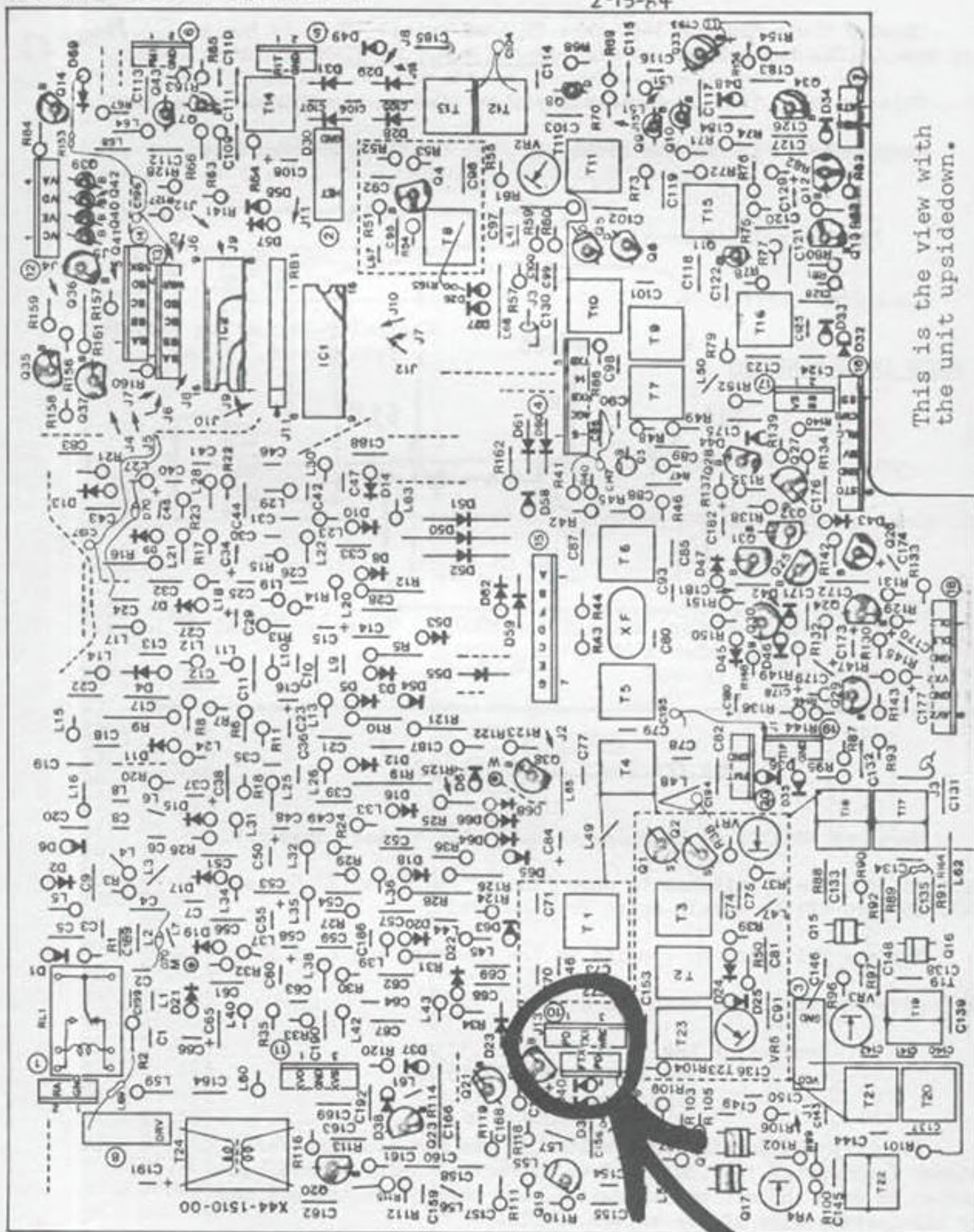

This is the view with the unit upsidedown.

FRONT

Pull the plug with three wires to unlock transmit frequency (#10).

- 25A1015
- 25C460
- 25A562
- 25K125
- 35K73
- 35K74
- MV-13
- 25C1815
-
-
-
-
-
- 25C1959
- 25C2538
- 25C2603
- 25K192A
-
-
- 25C2703
-
-
-
-
- GREEN

To get on the 11 Meter band: (Two different mods., suggest you try #1 first).

- #1. Remove J-10 on the RF Board. (That's it, no re-alignment needed)...
- #2. Remove D39 on RF Board, remove R148 on Control Board-near TXE. (No re-alignment either).

**I don't know what this is but for: W.A.R.C. Band, remove White jumper on R.F. unit #X44-1510-00...??? Input wanted as to what WARC is...???

YAESU FT-102

1. Remove lower case.
2. Locate the Local Unit (PCB) PB-2345, on lower side of radio. (Refer to BOTTOM VIEW on page 38 of FT-102 Instruction Manual).
3. Remove D-18 from circuit for 11 Meter operation, 29.0 - 29.5 now becomes 27.0 - 27.5.
4. Set PRESELECT on front panel to 8, RF AMP to ON, BAND SELECT on 29.0 ...
5. Locate T1009 on RF Unit (page 44, of manual), adjust for maximum noise level.

* An alternate modification to enable full 27.0 - 30.0MHz operation is shown below:

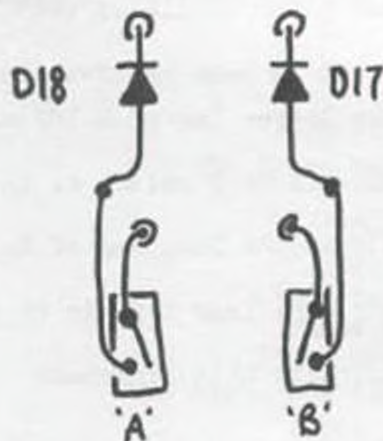

*Remove Anode side from PCB on both D17 and D18. Solder wires to diodes and to where removed as shown. Wire switches accordingly. Fo Table below:

	SWITCH	BAND	FREQUENCY
A*#1	A - closed B - closed	Any	Normal
A*#2	A - open B - closed	29.0	27.0-27.5
A*#3	A - closed B - open	28.5	27.5-28.0

A* Same modification using SCB switch Item #145, Fo's are (A* reference above).

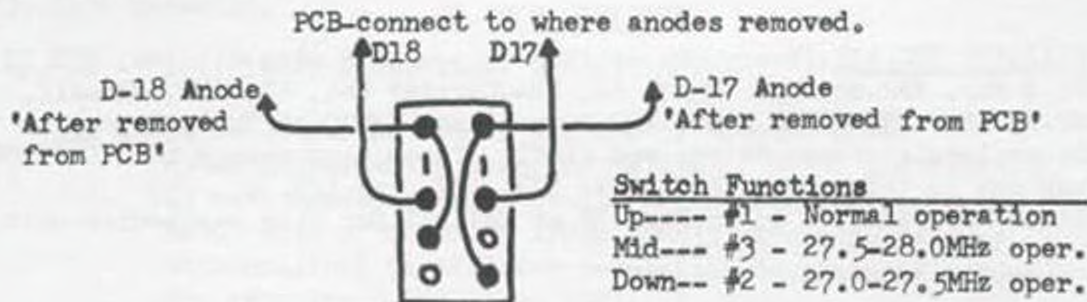

Switch Functions	
Up----	#1 - Normal operation
Mid---	#3 - 27.5-28.0MHz oper.
Down--	#2 - 27.0-27.5MHz oper.

Correction
Vol 19
Page 61

148GTL-DX: LATE (UPDATE)

I didn't want to hear this;.....two different circuit boards exist!
Slightly different, and have different numbers: pb-010AB (S/N 130187xx);
pb-010AA (S/N 130030xx). Major circuitry appears to be the same, but
discrepancy has been found in the BEEP wire.

To de-beep the newer board (pb-010AB): locate C-162 (2.2mf/25VDC)
and remove it!

To de-beep/mod. the older board (pb-010AA): locate the holes marked
C-162 (C-162 not in circuit), instead an Orange wire is coming from one
of the holes. That's the Beep wire; now do the standard mod in Vol. 15,
page 20.

(Ed. Note: IF any additional variances are found, H-E-L-P...!)

148GTL-DX: EARLY (UPDATE)

DX-Early Model (S/N 030027xx), unit does have the three xtals as
noted in Vol. 17 (X2-15.03MHz, X3-15.48MHz, X4-15.93MHz)..of 5 early
units checked all had these same crystals.

To "DE-BEEP" the early version: Lift the longer leg of R-187 off
PCB,—(located near the microphone jack). Disable Ch-9 switch as in
Vol. 15, Pg. 20 steps 1-6. Run a new wire from the long leg of R-187
lifted to the center of Ch-9 sw., run another wire from top pin of sw.
to where leg of resistor was lifted off PCB. With this finished:
Ch-9 to OFF, Beep is OFF; Ch-9 to CH-9, B-E-E-E-P.....

SPECIFIC TUNE-UP

REALISTIC TRC-451: (Everybody wanting it - was in with Kit 106, SCB 17, 36-37.)
VR1-S Mtr, VR2-Sq Rng, VR3-Tx Fo, VR4-Carrier Bal, VR5-AMC, VR6-AIC,
VR7-RF Mtr, VR8-Final Bias, VR9-Driver Bias, VR10-AM Tx Power.
Change insulators on driver and final! If you want change both to 1306/1307.
Peak out in this order: L40, L39, L38, L37, and L27....
Slider Modification is on Page 37 of Vol. 17 for this particular unit.

MOTOROLA CM540-SYSTEM 500/ELECTROSCAN (00S09 -PLL Chip)
40 Ch./10 Ch. Scan - Microprocessor Controlled C.B. Xcvr.

This unit isn't readily found on the 'junk' sales. Top quality and well designed, the Microprocessor is very good. Was bought in '78 for \$285 and only in shop twice since then - (1st time for being hooked up backwards; this time for RF Amp transistor - got zapped by a Linear up close).

A Factory Service Manual is necessity for working on this unit in depth - also the parts are not lettered on PCB - and if you don't really know electronics when you hit the microprocessor circuitry TROUBLE.....

Customer didn't want any modification done to this particular as is in wife's car. But have noticed an odd thing about the PLL chip - 00S09 (Pin out is similar to the following: MCL45104, MM55104/114/124, MN6040A, and SM5104 PLL chips).. Logic level of the 00S09 is 9.1VDC being the only difference - so theory wise should convert the same as SM5104. Pin-out function of unit is as follows:

9.1 VDC (chip B+)Vdd-1	16-D.C. Ground
Fin-2	15-PO, Logic Input-LSB
Osc in-3	14-P1, " "
Osc out-4	13-P2, " "
(*-no conn.)-5	12-P3, " "
Phase Det.-6	11-P4, " "
(*-no conn.)-7	10-P5, " "
Tied high, Vdd logic)-8	9-(Tied High, Vdd logic level, P7)
	(level, P6....

*(5)..Frequency select, 10KHz and 5KHz steps.

*(7)..Lock Detector,

Tune-up: RX - L101, L102, L103, T104, T105, T106..

TX - you've either got it or you don't, however power may be increased by changing values of R-307 and R-305. (If both resistors in circuit remove, and replace only R-305 with a 30 ohm 5% 1/2W. Don't exceed 5W deadkey with original final...for modulation increase if needed try removing R-205, then Q201...)

SUPERSTAR 2000 FINE TUNE UNLOCK MODIFICATION

- - 50 CH. SELECTOR VERSION - -

1. Follow the Blue and White wire from the clockwise rear section of Fine Tune potentiometer. It should connect to the emitter of Q-34, remove at that point. Note the point by cleaning out hole!
2. Follow the Pink and White wire from the Coarse Tune to the PCB. Connect the Blue and White wire removed in last step to this point in series with a 100 ohm $\frac{1}{2}$ W 5% resistor. Connect the cathode of a 1N4730 (ECG-5006A), to the junction of wire and resistor; connect the anode of zener to DC Ground. (3.6VDC power source created for fine tune).

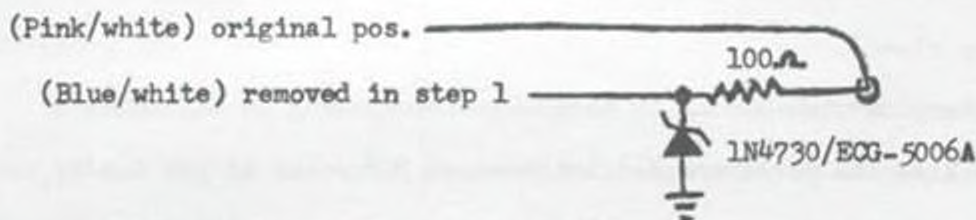

3. Remove the Green wire coming from the Mode switch to the Fine Tune pot, at the Fine Tune pot. Reconnect it to the emitter of Q-34 where hole was cleaned out.
4. Remove R15, (located next to X-5).
5. Disconnect the junction of D8 and R16 from the CL line at the cathode of D7, by unsoldering the junction ends from the run. Lift the ends and solder together. (Be careful to leave the path between D7 and R11 connected.) D8 and R16 are located toward the outside between X5 and the mic connector.
6. Solder, a 39K ohm resistor to where D8 and R16 have been soldered together. Solder the other end to where Green wire was soldered in step 3. (Emitter of Q-34.)
7. Bridge a 47K ohm resistor from D6's anode to DC Ground, on the bottom of PCB. (D6 located under mic socket) - This makes the Fine Tune slide up faster. Without this it sort of 'lingers', also decreases the Fine Tune slide range to about 1.3KHz; and makes it easier to handle.
8. Center up both the Coarse and Fine Tune Knobs, realign all the band crystals to put each of the bands back on center slot...

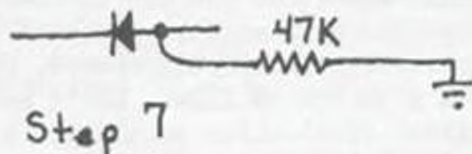
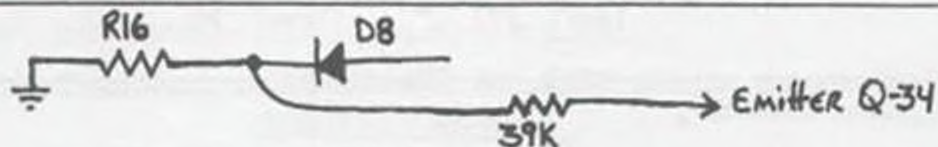

This modification gives: fine tune to the 148GTL and improves the usefulness of the 2000's fine tune. If you have converted your 2000; you probably noticed that at the extreme CCW position of the coarse tune; the fine tune has no effect on frequency-period. That is because the coarse tune is now at ground potential on it's swing, and fine tune has no voltage to add or subtract from.

This procedure will eliminate that problem. In my unit at the max CCW position of coarse tune: the fine tune moves the Fo 1.3KHz at max CW position, overall tuning range of fine tune is 2.5KHz.

For the 148GTL you will need a coarse and fine tune dual pot, with concentric shafts: front portion should be 20K and rear portion 1K, inner shaft should control rear pot. NOTE: Be aware, the shafts for the control used in 2000GTL will not fit the 148GTL, as the shafts are too short. Control will work however-but rubs the face plate of unit. Don't order it unless you just have to have as the cost is \$7.50 + shipping. (UPDATE: ON COST! - Try \$12.50 +, UPS collect; without knobs and knob collets!).

The right size control dimensions are: Outer shaft length from the top of bushing - 5/8", inner shaft length from the top of outer shaft is 3/8", bushing size is 1/4". As of this writing neither Uniden or Dynascan can provide this correct potentiometer. The Cobra 148GTL-DX has the ideal part, but no part # available. One note however: Dual Potentiometer Manufacturer is ALPS - if anyone can get ahold of their catalog - BINGO! Let SCB know immediately and will pass on information to all readers.

Parts required for modification of Fine Tune:

- 1 - 1K ohm resistor
- 1 - 4.7K ohm resistor
- 1 - 220 ohm resistor
- 1 - 10-turn 5K ohm trimmer
- 1 - Dual Pot as described above if going to do 148GTL.

Remove the following components: R-174, R-175, R-44, VR-5, R-187, R-188, D-51, D-52, and D-75. Wire up the potentiometer as shown below..

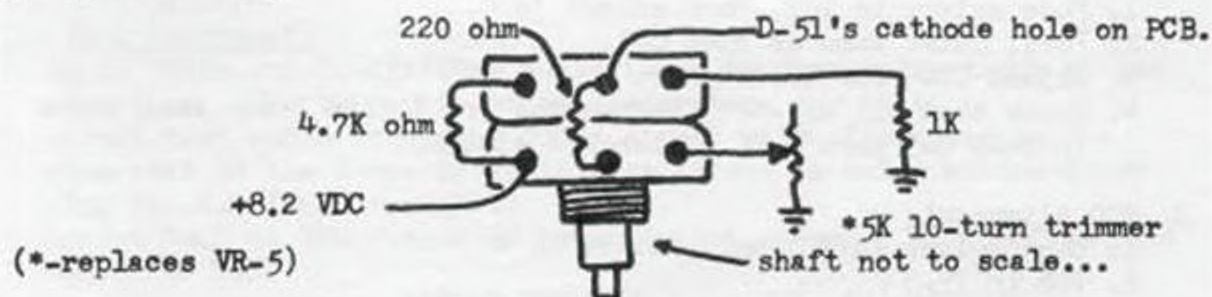

To align the frequency, center up the knobs and adjust all three modes for center slot. Now, decide how much slide you will need. The slide is adjustable from 5KHz to 20KHz, but only in the down portion. Upwards amount of slide will remain the same. Reason: Voltage is remaining constant at the top of control; but can adjust resistance to ground with the 10-turn trimmer; thus can control the amount of voltage drop. In most cases the slide up will be about 7KHz and down about 13KHz.

Remember the 5K trimmer will control the down slide, so if it doesn't go down that far - don't panic! Adjust the 5K trimmer, for the desired range. If you want maximum slide; the 5K 10-turn trimmer may be omitted; but insert a 100 ohm resistor in its place. This is a safety measure to prevent shorting out the 8.2VDC source, - *Murphy's Law!

This is Palomar 2400; Factory Alignment Proceedure; re-written slightly for the experienced technician.

Equipment Suggested: Audio Generator; RF VTVM; DC Power Supply (13.8VDC, 4A); Freq. Counter; Oscilloscope; RF Wattmeter & Dummy Load (over 15W desired); Sig. Gen. (capable of 1KHz at 100% mod and FM); Speaker Dummy Load (Resistive 8 ohm, 5W); VOM-20K ohm/V min.; Pulse Gen. (0-500Hz, 0-1V).

PLL ALIGNMENT

A. Reference Frequency Alignment:

1. Connect freq. cntr. to Pin 3, IC-1; should read 10.24000MHz. Tolerance ± 200 Hz; replace xtal if off; X-1 (10.24MHz).

B. 10.695MHz Alignment:

1. Mode Selector to USB
2. Freq. cntr. to TP-4
3. Adjust CT-11 to 10.695MHz; ± 0 Hz, -100 Hz
4. Mode Selector to LSB
5. Adjust CT-10 to 10.692MHz; ± 0 Hz, -100 Hz

C. Off-set Frequency Alignment:

1. Freq. cntr. to TP-1 (Pin 4, IC-2).
2. Mode select to USB - CLARIFIERS CENTERED, BOTH
3. Band select to A; adjust CT-2 for 19.655MHz, ± 50 Hz.
4. Band select to B; adjust CT-2 for 19.655MHz, ± 50 Hz.
5. Band select to C; adjust CT-3 for 19.880MHz, ± 50 Hz.
6. Band select to D; adjust CT-3 for 19.880MHz, ± 50 Hz.
7. Band select to E; adjust CT-4 for 20.555MHz, ± 50 Hz.
8. Band select to F; adjust CT-4 for 20.555MHz, ± 50 Hz.

D. LSB Off-set Frequency Alignment:

1. Mode select to LSB, Band select to C.
2. Freq. cntr: same as Step C-1.
3. Adjust CT-5 for 20.1035MHz.
4. Check that all off-set frequencies are 1.5KHz lower than those in Step C-3 thru C-8. Tolerance ± 300 Hz.

E. VCO Alignment:

1. Band select to F, Chnl. select to 40
2. VOM to TP-3
3. Adjust core of VCO-unit, cased - to 0.6V, ± 0.1 V
4. Band select to A, Chnl. select to 1
5. VOM should read less than 5.5V

TRANSMITTER ALIGNMENT

Adjust RV-6 (SSB Power Output) down to about 3W for easier alignment.

Also you might want to make a dummy plug wired for transmit mode, and separate audio input...diagram below:

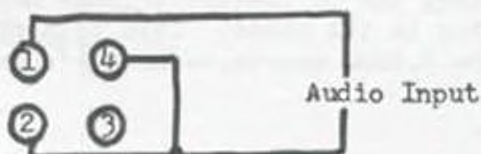

Dummy Microphone Plug wired to Transmit Mode..

TRANSMITTER ALIGNMENTA. RF Power Amplifier Alignment:

1. Set Mode selector to USB.
2. Apply 2.4KHz/20mV audio to mike input.
3. Set the Band select to F, Ch. select to 40.
4. Adjust T-1 and T-3 for maximum RF output.
5. Set the Band select to D, Ch. select to 1.
6. Adjust T-2 and T-4 for maximum RF output.
7. Repeat steps 3-6 until no further improvement can be made.
8. Set the Band select to C, Ch. select to 40.
9. Adjust T-5 and CT-8 for maximum RF output.
10. Set the Band select to A, Ch. select to 1.
11. Adjust CT-9 for maximum RF output.
12. Repeat steps 8-11 until no further improvement can be made.

B. Carrier Leakage Alignment:

1. Set Mode select to LSB.
2. Remove audio signal at dummy microphone plug.
3. Adjust RV-5 for minimum (Ideal condition is none) RF Output - any amount is carrier leakage!
4. Apply 2.4KHz/10mV audio to dummy mike plug. RF power output should be 40 db greater than the carrier-leak output.
5. Check step 4 in USB mode, same spec's with tone on/off.

C. RF Power Stage Alignment:

1. After finishing Step B above: change audio level to 2.4KHz/20mV input to dummy plug input.
2. Mode select to USB
3. Rotate RV-3 and RV-6, FULLY COUNTERCLOCKWISE.
4. Band select to E, Ch. select to 40.
5. Adjust T-5 and L-16 for Maximum RF output.

D. Two-Tone Alignment:

1. Apply 500Hz and 2.4KHz/20mV audio tones to dummy plug input at the same time. Use two audio signal generators for this.
2. Adjust test audio levels of 500Hz signal with attenuator on the generator so the scope presents wave figure as below at the dummy plug input. (Wave Form D-1)
3. Adjust RV-6 to 12W P-to-P RF Power Output. Scoped RF Output should look like D-1.

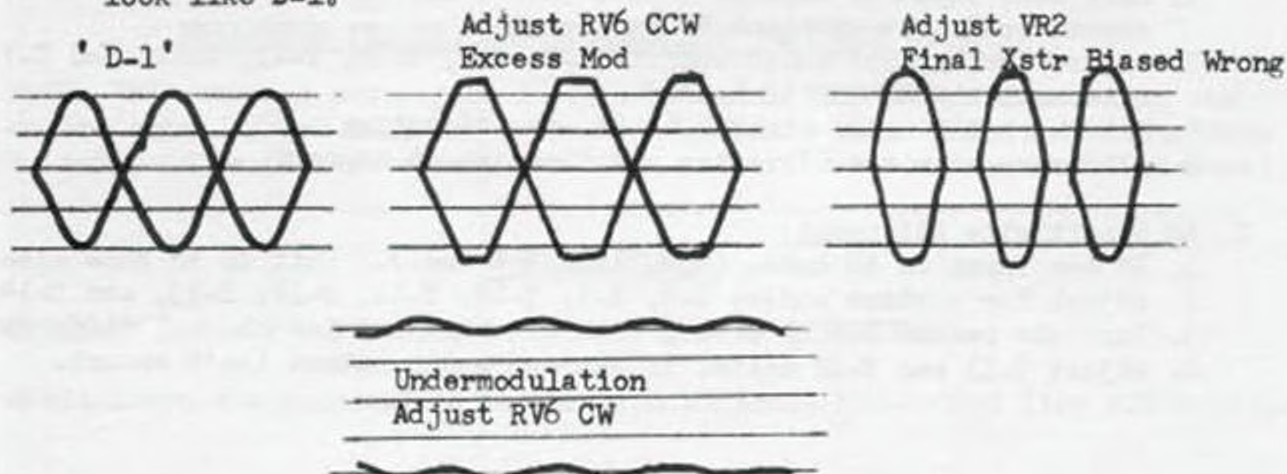

PALOMAR 2400, ALIGNMENT (Cont.)

TRANSMITTER ALIGNMENT (Cont.)

E. AM RF Power Output Alignment:

1. Set mode select to AM.
2. Band select to C.
3. Ch. select to 20.
4. Adjust RV-11 for 7.5W RF power output.

F. AM Modulation Alignment:

1. Apply 2.4KHz/7mV audio signal to dummy plug.
2. Adjust RV-12 for modulation depth of greater than 90%....

G. FM RF Power Output Alignment:

1. Set mode select to FM.
2. Adjust RV-3 for 10W RF power output.
CHECK RF POWER ON ALL CHANNELS - SHOULD BE IN EXCESS OF 9W.

H. FM Deviation Alignment:

1. Mode selector should still be at FM.
2. Apply 1,250Hz/20mV audio to dummy plug.
3. Check RF output with Deviation Meter for 2-3KHz of deviation, adjust RV-1 if needed.

I. RF Power Meter Alignment:

1. Set Mode select to AM.
2. Compare the external RF power reading against the built-in meter.
Adjust RV-4 for equal indication.
3. REMOVE DUMMY PLUG.....

RECEIVER ALIGNMENT

A. SSB AGC Alignment:

1. Set mode select to USB.
2. RF gain to maximum, (DX/Loc to DX).
3. Adjust RV-7 for 2VDC, at terminal #28.
4. Mode select to AM, make sure the voltage in vicinity of 1.8-2.3VDC.

B. SSB Sensitivity Alignment:

1. R.F. Gen. input to antenna input, output in: USB 26.965MHz; attenuate signal as to not overload RF Amp in unit.
2. Adjust for maximum audio output: T-8, T-9, T-10, T-11, T-12, and T-7.
Attenuate the RF Gen if needed.
3. Make sure the noise blanker is ON when adjusting.
4. Also make sure the Clarifier and Fine are at center!

C. AM Sensitivity Alignment:

1. RF Gen input to AM mode, (1_mV, 1KHz/30% mod.). Unit to AM Mode also.
2. Adjust for maximum audio: T-8, T-9, T-10, T-11, T-12, T-13, and T-14.
3. Turn the peaked T-9 by $\frac{1}{4}$ to $\frac{1}{2}$ clockwise to minimize channel difference.
4. Adjust T-11 and T-12 again, if maximum audio output isn't enough.

PALOMAR 2400, ALIGNMENT (Cont.)

RECEIVER ALIGNMENT (Cont.)

D. FM Sensitivity Alignment:

1. RF Gen to FM Mode, (1_mV , 1KHz mod., 1.5KHz deviation.) Disconnect from antenna connector.
2. Mode select to FM on unit.
3. Adjust T-16 for maximum noise.
4. Connect RF Gen to unit, adjust T-15 and T-16 for maximum audio output. (Note: T-16 has three peak points, choose the one with maximum)

E. Sensitivity Specifications-Check:

- AM - less than 1 micro volt, S/N 10db.
FM - less than 1 micro volt, S/N 20db.
SSB - less than 0.5 micro volt, S/N 10db.

F. S-Meter Alignment:

1. Adjust SSB mode first... 100_mV input (40db) at the antenna jack.
2. Adjust RV-9 for needle swing to 'S-9'
3. Adjust RV-8 for needle swing to 'S-9' in the AM mode.

G. Squelch Alignment:

1. Change generator output to 200_mV (46db) in AM mode.
2. Set Squelch to maximum in unit, then adjust RV-10 for no audio output.
3. Check that squelch functions in all modes, within the range of 40-56db.

H. RF Gain (Dx/Loc) Check:

1. Set Sig Gen at sensitivity of S/N 10db on AM mode. Unit to AM and DX.
2. Adjust Volume for audio output of 2V (500mW), radio's volume control!
3. Dx/Loc to Loc, readjust the Sig Gen in output until the audio output of radio is 2V (500mW) again.
4. Difference in Sig Gen output should be between 15db-35db.

I. N.B. Check:

1. Connect 2-input pad to antenna connector.
2. Signal #1 to be 100Hz 1_mV ; Signal #2 to be 100Hz, 1_m Sec Pulse Width, 500mV P-P.
3. Should be at least 7db S/N ratio between NB OFF and NB ON.

END OF PALOMAR 2400 ALIGNMENT..

REALISTIC PRO-22, VHF-H/U, AIR, UHF PORTABLE SCANNER

NOTE: The external power jack is wired for tip NEGATIVE! If you find one on the outs - check Q-15 and R-80.. - might have been lucky! If not, there is going to be plenty to keep you busy...(Cuss, that high-priced Engineer!)

SPECIAL NOTES:

Citizens Radio ? - supposed to be the same as Colt 1200..

Orbit-Sonic ? - supposed to be the same as Kraco KCB-40003? (try KCB-4003 1st)!

SPECIFIC TUNE-UPS

Hygain IV Md1. 673, Base: RV103-AMC, RV101-Sq Rng, RV104-Tx Mtr, RV102-Rx Mtr.
Tune L-111, L-109, L-108 for max RF forward output. (*)

Kraco KB2345, Base: RV2-AMC, RV1-Sq Rng, RV3-Rx Mtr, RV4-Tx Mtr.
Tune L-7, L-8, L-9 for max RF forward output: 12W final push it! (*)

(*) Xtals for extra Fo's - Vol. 1; Low Fo conversion Vol. 11, pg. 36;
Xtal switching Vol. 15, pg. 64. --both units...

G.E. 3-5813B PLL02A: RV1-Sq Rng; RV2-AMC (Don't defeat); RV3-Rx Mtr; RV4-Tx Mtr;
RV501-AWI adjust. Tune L12, L11, and L7 for max forward.
12W Final, change insulator to mica type.

LAFAYETTE OWNERS

As most of you know by now Lafayette is no longer in the C.B. business.
But...have found the source for parts, manuals, service...(U.S. MODELS ONLY)

Terryville Electronics, Inc.; 693 Old Town Road; Terryville, New York 11776
Ph. No. 516-473-0192 Re: Ellen at TEL.

COLT OWNERS

People have been writing to find the source of parts for Colts:
Had a time finding it, but was pleasantly surprised! CO-OPERATION in
capitol letters! (U.S. MODELS ONLY)

Cibcos; 625 Academy Drive; Northbrook, Illinois 60062-2472
.... Re: John Malloy...(Suggest you write as are also a LARGE electronics
wholesale ONLY distributor) Mark letter ATTN: John Malloy...

SBE OWNERS

All I received was a change of address, no particulars!

SBE, Inc.; 4700 San Pablo Ave.; Emeryville, Calif. 94608 Ph. No. 415-652-1805

PALOMAR OWNERS

All I received was address, no particulars!

Palomar Electronics Repair Service; 1320 Grand Ave.; San Marcos, Calif. 92069
Ph. No. 619-744-0720

TROUBLE-SHOOTING TABLES

The following 5 pages are re-written/modified trouble-shooting charts
for use by the technician; use in correlation with original schematic if
needed. In most cases the chassis are identical.

This is Rec86345 PLL SSB Chassis Trouble-Shooting Chart
Use in correllation with appropriate SAMS, Reference Radio Shack TRC-448.

Acc; will be used instead of; associated circuitry components in text!

NOTE: Check PLL first, with Ch. Sel at CH-19.

Frequency Counter at TP4, ck for following: 1. 34.985MHz, AM-Rx
2. 19.3825MHz, LSB-Rx/Tx

If both frequencies OK, PLL is functional. If not see below..

- F_o wrong in AM - ck Q5, D6, L2, Q9, X2, Q11, IC1, Acc.
- F_o wrong in LSB - ck Q4, D5, L1, Q1, T1, Q10, X3, Q11, Acc.
- Both wrong - ck IC2, X4, Q3, Q4, Q6, Q7, Q8, Q13, Ch. Sel. Sw., Acc.

General Trouble-Shooting

- Meter lamp out, set dead - ck power cord, Q229, meter lamp, fuse
- Fuse blows - ck for reversed polarity hook-up, D2104, Q299, D244.
Collector short to chassis-Q204, Q205, Q234, Q235. Acc.
- Meter lamp out in Rx - ck D229, lamp
- Meter lamp out in MON/PA - ck D230, lamp
- Mod. Indicator, no flash in AM - ck Q218, D226, D227, lamp

Receive-Transmit Trouble-Shooting

- No Rx in SSB; OK in AM-Rx, AM/SSB-Tx: ck Q215, Q216, Q217, Acc
- No Rx/Tx in SSB; OK in AM-Rx/Tx: ck Q1, Acc
- No Rx-AM/SSB, No Tx-SSB; OK in AM-Tx: ck XF201, Q207, Q208, T207,
T208, Acc.
- No Rx in both AM/SSB: ck Q223, Q224, Q235, and Acc.
- No audio; OK in Tx-AM/SSB: ck speaker, Ext. Spkr. Jack, Squelch
Control, Relay, Acc.
- No Tx-AM/SSB: ck Q201, Q202, Q203, Q204, Q205, Relay, D251, Mode
Sw., Mike Cable/Plug/Sw., Acc.
- No Tx-AM; OK in SSB Tx: Q236, D228, Mode Sw., Acc
- No Tx-SSB; OK in Tx-AM and Rx-AM/SSB: ck IC3, Q15, Q17, Q18, D19,
D20, D21, D22, T9, D211, D249,
D250, Acc.
- No function on Squelch control: ck VR209, VR302, VR206, Q230, Q231, Acc
- Rx oscillates in AM; OK in Rx-SSB: ck D1, Mode Switch, Acc
- Low sensitivity Rx-SSB; OK in Tx-SSB: ck Q219, Q220, Q221, Q228,
Q223, Q224, Q225, Acc
- No modulation in AM; OK in Rx-AM, Tx-SSB: ck IC3, Q15, Q17, Q18,
T216, Acc
- Rx AGC and SSB ALC inoperative: ck Q214, Acc
- Noise Blanker/ANL inoperative: ck IC201, Q226, Q228, D236, D237,
D238, D239, D216, NB Switch, Acc
- PA inoperative; CB operation OK: ck PA/CB Sw., PA Jack
- RF Gain inoperative: ck Q220, D253, VR302, Acc
- Clarifier inoperative (As is clarifier, not modified!): ck D12,
D13, D14, VR304, VR2, Acc

Remember this unit has separate VCO's for AM/USB and LSB...

The above should help out those persons who have been trying to repair the TRC-448's, since the Custom Conversion appeared in Vol. 16..

NOTE: When doing full-blown modification it has been necessary to change D5 and D6 to "Super Diodes" in about 1 of 10 units for full frequency coverage..

.....This is the O2A 2-Board SSB chassis Trouble-shooting Chart.....
 Use in correlation with appropriate SAMS, Reference GE: 3-5875A

NOTE: No attempt has been made to cover all eventualities. However, known trouble areas have been included to reinforce standard troubleshooting techniques.	
Dead unit (CB)	Blown DC input fuses, F & F1. 13.8 volt DC supply line open, S9 On/Off switch defective; D24 shorted; CH or LB open.
No sound from speaker - external speaker works normally	External speaker jack (J4) open or defective. Open or defective speaker.
No sound in Receive mode; no modulation in Transmit mode.	Check voltage for proper operation of IC2 (AF Amp) and Q13 (AF Amp). Using a scope check for presence of audio input at pin 6. Check for audio output at pin 10. IC2 is used as a Power Amp in AM, a Mic Amp in SSB.
No modulation in Transmit; Sound normal in Receive mode.	AM: Defective microphone. Check for proper operating voltages of Q13, Q19, Q18, Q20. SSB: Defective microphone. Check for proper operating voltages of Q13, Q20. Check IC1 for proper operation with SPEECH COMPRESSOR on.
No sound in Receive mode, modulation normal in Transmit mode.	Check VR2 volume control for open or intermittent wiper contacts. Check squelch circuit Q15, Q16 & Q17 and associated components.
Squelch control will not squelch background noise.	AM: Improper adjustment of trim pot. RV7 (check Alignment Instructions for proper adjustment). Q15, Q16, Q17 defective. SSB: Improper adjustment of trim pots. RV7 or RV8 (check Alignment Instructions for proper adjustments). Q15, Q16, Q17 defective. Note: Squelch circuits receive signal from AGC line.
RF/IF section of Receiver dead.	Check for proper voltage on Q209 & Q210. Using frequency counter, check output of T203, if no output check PLL circuits.
AM IF section of Receiver dead.	Using frequency counter, check for output from Q202. Check Q5, Q6, Q8 & Q9 for proper operating voltages.
SSB IF section of Receiver dead.	Check for proper operating voltages of Q7, Q8, Q9 & Q10. Using a frequency counter, check for output of TP5.
Receiver off frequency.	Check synthesizer alignment. Check for proper operation of clarifier VR3. Check D204 and D205.
No RF output from transmitter.	AM: Check D202, Q206, Q207, Q208 and Q20 for proper voltages. SSB: Check IC202, IC1, Q206, Q207, & Q208 for proper voltages. Check for proper adjustment of RV201 (See Alignment Instructions).
Weak RF output from transmitter.	Check transmitter alignment; operating of transmitter stages IC202, Q206, Q207, Q208 and associated output components.
High VSWR reading, (AWI indicator lights).	Check antenna connections, must be clean and tight. Check coax cable for open, shorts, or weather deterioration. Note: AWI not used in SSB mode.
Transmitter off frequency.	Check D204 & D205 for open. Check synthesizer and transmitter alignment. (See Alignment for proper adjustment).
Can not transmit or intermittent transmit.	Check microphone for intermittent or open leads.
Transmit modulation distorted.	AM: Check Q13 & Q20 operating voltages, RV9 adjustment. (See Alignment Instructions). SSB: Check Q13, Q20, Q18 & Q19 operating voltages.
Noise blanker does not operate	Check for proper voltages on Q211, Q212, & Q213. Check for defective switch S3.
Incorrect S/RF meter reading.	Check Alignment Instructions for correct adjustment of RV5 & RV203 (AM) and RV4 (SSB). Check for defective meter rectifiers D8, D9 & D227.
PA function not operating.	Check S7, Jack (J3) and PA speaker.
Clarifier inoperative	Check VR3 for intermittent or open wiper contacts. Check for open D204 or R221.
Set works in DC but not AC	Check Q1, Q2, and Q501 for proper voltages. Check for proper adjustment of RV1 (See Alignment Instructions).

This is 858 SSB Chassis Trouble-Shooting Chart

Use in correlation with appropriate SAMS, Reference Radio Shack: TRC-449

- General: Unit will not turn on: Broken Power cable, Fuse Blown (Check cause),
Bad Power Switch, wiring to power supply okts.
No RX: Defective RF ckt, Noise Blanker, AGC, PLL ckts. Also Ant. Conn.
No Sound: RX Power, RX Audio, PLL ckts. Channel Switch, PA/CB switch,
Ext. Sp. jack, and SQ ckts.
No TX: Microphone, Relay, Power supply ckts., PLL ckts, Mike Amp/Bal.
Mod. ckts, TX Amp.
No Mod: Mike/connector, TR20 or IC4 (AM Mode), Mike amplifier.

Amplification:

- No Rx Sound: 1. Check for short ckt or broken wire in output Xfmr (T1) also
cold solder joints on PCB. Pri-0.2 ohm, Sec.-0.5 ohm.
2. Audio Chip-IC4, Pin 10 should be approx 7VDC.
3. Squelch always on: TR12, TR13, TR14, TR21, also check for
cold solder on Sq cntrl ground.
4. Sig. Mtr deflects: D10, D11, D12, TR15.
5. No Audio even in SSB mode: FET-1, TR9, TR8, TR6, TR5, TR4.
No TX-AM: 1. TR43, TR44, TR25, TR26, TR27, TR28, FET6, FET7, D7, D35 and
related circuits.
No TX-SSB: 1. If AM TX and Modulation O.K., TR6, IC2, TR16, FET7 and related
circuits.
No AM Modulation: Signal flow is IC3, D22, D21, TR20, TR22, IC4; also check
TR18, TR19.
No Noise Blanker Operation: Mis-alignment of L1 and L2, TR1, TR2, TR3.
No LED Channel indicator Lights: TR36, TR37, if unit has sockets to these
check also for corrosion build-up.

* * * * *

PLL Chip Trouble-shooting:

Should be RF at TP8; if not—check for 9.2VDC approx at Pin 1 IC5; if so
IC5 bad, L17 open, poor soldering. No voltage
D44 bad, L16 open, soldering again.

- Should be 2.2VDC at.....—1. Check for 0.5V P-P RF at TP6; if not
TP7; if not..... ck TR40, L24, TR34, TR38, TR39, X3, X4,
X6, selector switch, and poor soldering.
2. If RF present, ck Pin 5/6 IC7 for 10KHz
Sawtooth waveshape. If not there, Ck for
5VDC Pin 2 IC6, X5, IC7, poor soldering,
also 5VDC P/S line.
3. Ck Pin 13-21 IC7, logic per truth table
vs selector. If not, ck at switch and
cable, for bad sw or cable.
4. Ck Pin 11 IC7 for readable MHz signal,
also at base TR30. If not, Ck FET4, L19,
TR30, TR31, TR35, defective soldering pins
2, 3, 4 of IC7.

TP7, Check that the Ch.....—Recheck Step 3 above, double check the cable
F6 matches truth table;.... contact with socket..
if not.....

TP7, Ch. 1 on selector;....— Realign L-17...
Check for 2VDC, if not.....

IF AFTER ALL ABOVE CAN'T GET PLL TO WORK CORRECTLY! - BAD CHIP!

This is MB8734/MB8719 PLL SSB Chassis Trouble-Shooting Chart
Use in correllation with appropriate SAMS, Reference: Radio Shack TRC-450

- General: Unit will not turn on: Broken power cable, blown fuse (check cause),
bad pwr sw., defective wires/poor soldering.
No Rx: Defective-RF, Noise Blanker, AGC, PLL ckts. Ant. conn.
No Audio: Bad-mike/conn., Rx pwr source, Rx audio ckt., PLL ckt.,
Ch. Sel. sw., Sq. ckt., PA/CB/MON sw., Ext/Both/Int sw.,
Ext Spkr jack.
No Tx: Bad-mike/conn., Ant. conn., Tx power source, PLL/Carrier
Osc ckts (bad or out of alignment), mike amp/bal. mod in
SSB mode, Tx Amp-(between mixer and final stage).
No Modu: Bad mike/conn., TR20, IC4, mike amp.

Amplification:

- No Rx Sound: 1. IC4 pin 9 should be 6VDC approx.
2. Sq. always on-TR14, TR15.
3. Meter deflects - thru IF stages O.K.
No AM-D21, D22, D24, TR13, VR403, TR36, IC4
No SSB, AM-O.K.; ck F_o and level TP3-none, ck Xtals,
TR22, TR21, TR20.
No SSB-check Detector, TR13; AF stage, VR403, TR36, IC4.
4. Meter doesn't deflect-TR9, TR10, TR17, TR18, TR42, TR16,
FET1, TR8, D13, D14. Check TP1 F_o
for possible PLL being bad.
Noise Blanker In-op: TR1 thru TR8, D1, D2; mis-alignment L1 and L2.
Ch. LED doesn't light: Bad LED segment or contact, all segments TR23.
No Tx: Ck IC5-13.8VDC on Rx, 0VDC on Tx; if not TR37, mike/conn.
Ck IC5-8VDC on Tx; if not Tx B+ line shorted or bad IC.
Ck F_o at TP3 for carrier oscillation; if not ck TR22, TR21, TR20,
D26 thru D31, X1 and X2.
Carrier OK, No Tx; ck F_o at TP1 against F_o Table. If not
the same PLL Ckt defective. OK-ck IC3, IC6,
TR38, TR39, and TR41.
No Tx-SSB mode and no mod. AM mode; Mike amp, ALC/AMC ckts bad,
ck TR31, TR33, TR29, TR28.

* * * * *
PLL Chip Trouble-shooting:

- Should be RF at TP1; if not—check IC1 Pin 1 for 8VDC, if there ck
IC2, L13 open/poor soldering. If not,
ck IC5, L16 open/poor soldering.
Should be 2-5VDC at TP1; if not—1. TP10 should be 1-2V P/P RF,
if not-ck emitter TR24 for 11.3258MHz
(F_o depends on Xtal in unit) if there
ck for bad TR23, TR14, L18 or poor
soldering. If not ck for bad Xtal,
Sw. Ckts, TR24.
2. If 1-2V P/P RF at TP10, ck Pins
11-16 of IC2 program logic. If not
ck the Ch. Sw./cable-Program OK-
then chip bad.
Check each Ch's F_o at TP1 per Logic Chart: If good, check TP9 for 3.5VDC
when Ch. Selector at Ch. 40. If not
readjust L13...If this all checks out
then PLL Chip is GOOD...

This is uPC2824C/uPC2816C PLL SSB Chassis Trouble-Shooting Chart
Use in correlation with appropriate SAMS, Reference: Radio Shack TRC-451

Will forego usual General Trouble-shooting and go straight to amplified instructions:

Unit will not turn on: Broken power cable, blown fuse (check cause), power switch, wires/soldering in power supply ckts.

No Rx Audio: 1. Bad RF, Noise Blanker, AGC, PLL ckts. Audio IC, antenna conn. Mike/Cable/connector.

2. Check IC4, Pin 5 should read 6VDC approx.

3. SQ always on - TR11 or soldering.

4. Meter deflects on Rx - antenna thru IF is OK.

No AM - check D22, D23, D24, TR18, TR10, TR11, VR401, TR36, and IC4.

No SSB, have AM - ck F ϕ and level at TP5, also Xtals and TR23.

No SSB - TR10, TR11, VR401, TR36, and IC4.

5. Meter has no deflection on Rx - ck TR12, TR13, TR14, TR15, TR16, TR17, D4, D10, D11, and IC1.

---Still no audio go to PLL ckt.

No Tx: 1. Tx power sources, Mike/cable/conn., Ant. conn.

2. PLL, Carrier Osc., adjustment off.

3. Mike amplifier, Balanced Modulator in SSB mode.

4. Check TP3, if no carrier F ϕ - TR23, D34, D35, D36, and X2

5. Carrier OK - no Tx; check PLL ckts, if OK; ck IC3, IC5, TR38, TR39, TR40, and TR41.

6. No Tx on SSB, No mod. in AM modes - Mike amp, ALC/AMC ckts. TR42, TR43, TR44, TR45, and TR46.

No Mod: check mike/cable/conn.

No Noise Blanker: check TR1, TR2, TR3, TR4, TR5, TR6, TR7, TR8, D1, D2, first check alignment of L1 and L2.

Ch. LED inop: if segment out, probably the LED itself; check selector sw. and wiring to it.

* * * * *

PLL Chip Trouble-shooting:

Should be RF at TP3; if not—check for approx. 8VDC at collector of TR21. If there, check IC2, L14 open/poor soldering. If not, check TR34, TR35, L15.

Check TP2 for 2-5V; if not—check for 1-2V P/P RF at TP4. If not, TR22 should read 10.2417MHz. If not, check Xtal, switching ckt, TR22. If there check TR23 or L18, soldering.

IF, 1-2V is at TP4, check Pins 1-6 IC2 logic programming/truth table. If not there check Ch. Sw./cable. If there and all above checks good then you have bad PLL.

Check TP2 for ea Ch. F ϕ per table—check for 3.5VDC at Ch. 40.

If not there, readjust L14. If all the above checks out then PLL Chip is GOOD.

COERA 135XLR (TC5080P Divider-NOT PLL!) - UPDATE

Found this unit at yard sale, as-is for \$20.. Decided to fix/modify and sell, have a very good Zebra which couldn't beat anyway.

After getting into unit found bad Final and Clock, (forget ordering a clock for this unit - \$!)

TROUBLE: Don't know if Vol. 10 pg. 43 is wrong or there was a production change. Anyway Pin 8 of TC5080P is tied to Pin 13 with etch under the Chip.

To modify correctly: Push/Pull Pin 8 up to the component side, or remove chip and bend pin 8 up before replacing the chip on PCB.

Following is chip, switch modification - follow to the letter.Use the drawing below for Steps 1-4, clean out all holes on push button assy board.....

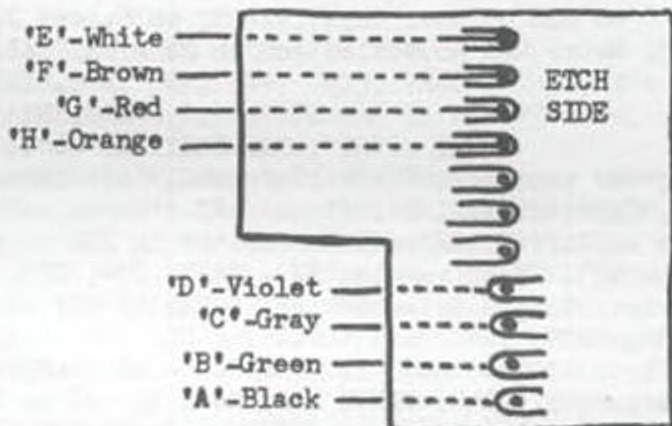

1. Remove wires: A, B, C, D, E, F, G, and H; from the push-button assy board.
2. Remove wires A, B, and C from other board, solder wire D to where wire C just removed. (Cut to length, as are 'hard-wiring' the PA/CB to permanently CB.)
3. Remove wires E, F, and G from other board, solder wire H to where wire G just removed. (Cut to length, as are 'hard-wiring' the NB/ANL permanently on.)
4. Turn unit on and double-check to see that you wired everything correctly so far.

Wire up the push-button assembly board exactly as drawn below, wires-1'. Use 4-wire ribbon cable (solid), or any solid wire.

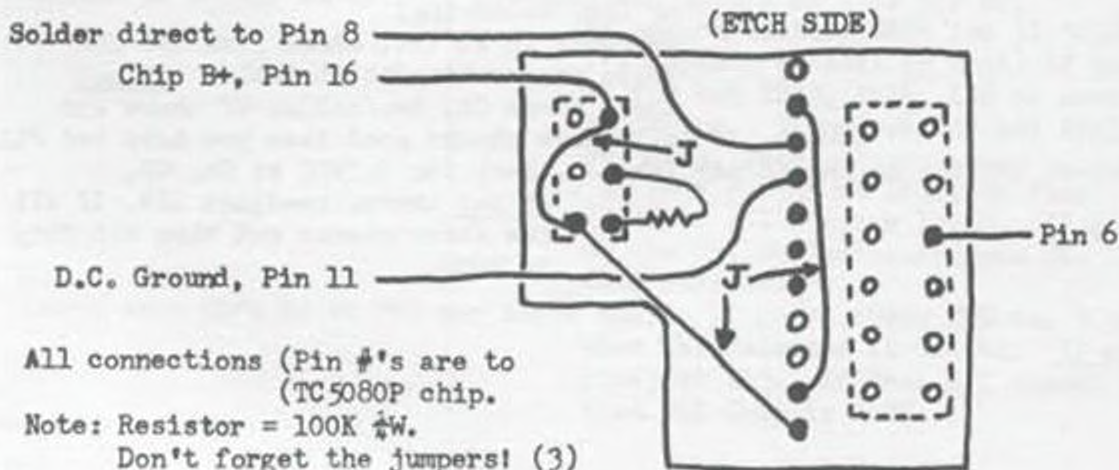

All connections (Pin #'s are to TC5080P chip.

Note: Resistor = 100K $\frac{1}{4}$ W.

Don't forget the jumpers! (3)

Do slide mod per Vol. 10, Pg. 45...Note: S/N on this unit, 40-088XX.

NB/ANL Button Down - Low Fo's. PA/CB Button Down - High Fo's.
Both down, still the same as the NB/ANL down.

Freq. Chart: <u>LOW</u>		<u>HIGH</u>	
Selector	Frequency	Selector	Frequency
27.....	26.795	3.....	27.145
28.....	26.805	7.....	27.195
29.....	26.815	27.....	27.435
30.....	26.825	28.....	27.445
31.....	26.835	29.....	27.455
32.....	26.845	30.....	27.465
33.....	26.855	31.....	27.475
34.....	26.865	32.....	27.485
35.....	26.875	33.....	27.495
36.....	26.885	34.....	27.505
37.....	26.895	35.....	27.515
38.....	26.905	36.....	27.525
39.....	26.915	37.....	27.535
40.....	26.925	38.....	27.545
		39.....	27.555
		40.....	27.565

LINEAR TIPS — Problem: SQUEAL ON TX.

Radio is good! But when hooked up to linear: SQUEAL!

Try following, as has worked with units:

1. Check grounds on Radio, Linear, and Antenna.
2. Check for NO voltage drop to either unit when keyed up. This is the main cause of squeal. Voltage/Current limiting!
3. Try different lengths of coax between the radio and linear.
4. Take case off radio, check for a small disc capacitor on the audio chip to CASE GROUND. Remove it, and try again.
- This has worked with the Uniden SSB chassis before -
5. The microphone can also be a source of problem. SQUEAL after all is nothing but RF FEEDBACK. To eliminate if microphone is the problem: Go to straight cable, instead of coiled. In difficult cases an RF filter in the transmitter audio input is needed. Try the following: Ferrite bead on audio input lead, .001MFD from audio input lead to D.C. Ground, or a filter network on the audio input. See below for two different types:

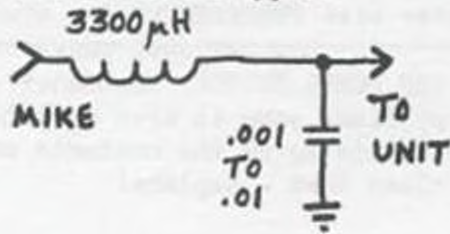
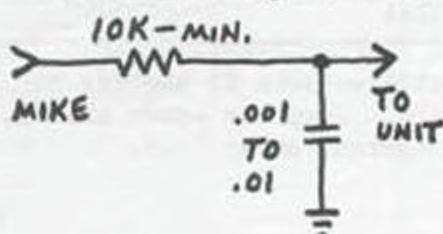

HINTS/KINKS/GOOFS

As usual all information utilized in this column does not receive a free volume. However have reviewed info sent in for use here and put it elsewhere, and many have received the Freebie! So, keep them coming.....

Goof: Drifting in PLL/Clarifier circuitry, did it to myself!
Solution: When changing capacitors in above circuitry; use NPO disc type; and won't have this problem..

AGAIN-LAST TIME: Relays for 858 SSB chassis, Sources -
Radio Shack (Special Order) Cat. No. 21-1562; Relay-RL027, Man. P/N: 2RLY027001
Uniden (Special Order) Grant-858; Item No. RLL; Part Name-Relay, P/N: 2400-001
Dynascan-Cobra (Special Order) Cobra 139XLR; Item No. RLL; Part Name-Relay;
Part No. 441-017-9-001.
Midland (Special Order) Midland 79-893; Item No. RLL; Part Name-Relay;
Part No. 79-105001.

Fact....Radio Shack is getting \$16+ for this relay. Have no input on what the others are getting. Also still have found no source for these at wholesale/reasonable price...

NOTE: A lot of people are buying new relays when it isn't necessary. Take off the plastic case and disassemble the relay to where you can get a burnishing tool inside where the center contacts are and burnish. Be careful when taking spring on/off, or will spend some time trying to find that small spring. If burnished carefully will last a long time.

Cobra 2000, Dual Clarifier Pot: If you want to order to customize unit, be advised that Dynascan is getting \$12.50+ for it! WITHOUT knobs and knob collets.... Note: Shafts are too short for putting in 148GTL-DX...

Nurd Channels? Re: SCB Vol. 11, Pg. 19...These are the left out Fo's between Ch. 1 and Ch. 40 (26.995, 27.045/.095/.145/.19 MHz)

Courier Galaxy - Problem with low modulation even after disabling AMC? Check R-90; SAMS says 15K, but have found 33K in everyone checked.. Change to 10K and plenty of it, will probably have to put the AMC in ckt.

Problem on Pres. Madison breaking up on LSB on Tx; Mod. scratchy; Low Pwr! AM and USB had everything O.K....Found LSB Voltage source erratic, cause was the AM/USB/LSB switch dirty - cleaned switch! Cleaned up problem too!

Tristar 747 - Problem scratchy sounding transmission on SSB.... Check for missing part around Q38 circuitry, C184! Should be 470Mfd/16V electrolytic there. If after replacing doesn't clear up problem, change Q38 (2SD325) to a 2SD839.....This should clear up everything...

CAUTION: GE 3-5811B, markings on the rear of chassis are correct as to plug polarization...Bass-Ackwards! if you don't have the DC power cord that came with it originally. Reverse wires inside unit, and re-mark the outer case PERMANENTLY for standard cable!

CHECK THE POWER SWITCH: On older units that have been in service for a while problems seem to crop up intermittently. Jump the power switch, carbon builds up on the contacts and loose current under load. Don't clean them - Replace!

Yes, there is a place for parts, service manuals, owner's manuals, and SERVICE.

Radio Parts/MCS Inc.; 735 28th Street, N.E.; Grand Rapids, Michigan 49508
(616-245-1276) Re: Art Poissons...

"Bought everything Robyn had when dropped out of CB business. Parts are available for most 23 and 40 channel Robyn models. Factory Service Manuals for 40 ch. units only. Owner's Manuals for most 23 ch. units, all 40 channel. Service available on all units. - Robyn's head tech (8 yrs.), went over to MCS and has been with them for almost 5 yrs now... - so if you have problems....
Re: Gary Wood...."

TECH./SERVICE NOTE: ROBYN SB540D

If the internal MIKE GAIN POTS (Not AMC or AIC) are turned to maximum.... Excessive amount of hum/noise will be heard on the AM carrier and when modulating in SSB mode...(GW).

Radio Parts/MCS Inc.

* * * H E L P - W A N T E D * * *

We at SCB want to expand service to Techs/Readers by providing addresses of parts sources for those CB companys that have gone out of business....Especially the more popular models put out by them.

If you know of sources, have THEM write to us giving the following information: On their Letterhead...

- Parts: All or partial
- Manuals: Owner's and Service
- Do they service: COD or Prepaid Cashier's Check
- Address/Zip/Phone No. (Include Area Code)
- Person to contact: Owner or Head Tech.

Parts for following Brands needed at this time:

- | | |
|------------------------------------|-----------------|
| Stoner..... | Handic..... |
| CPI..... | Lake..... |
| SBE (Note: Also the SBE Scanners!) | Palomar..... |
| Tram..... | Boman..... |
| Royce..... | Gemtronics..... |
| Browning..... | Dak..... |

Ed. Note: On above I am talking about companies with an inventory! Not the CB shop with "we service all brands", want the person/companies that bought inventory of parts.

Will publish in Vol. 19 all addresses received and update in every future volume if needed.

Complete Alignment Procedures for BOTH units (Identical)...FACTORY.....

Equipment needed for complete alignment: Oscilloscope; Dummy Load; D.C. Power Supply; VTVM; Sig. Gen. (capable of 27MHz oper. - 1KHz, 30% AM Mod., 1KHz-1.5KHz Dev. FM Mod.); Frequency Counter. (Power Supply at 13.8VDC)
RF Watt Meter.

PLL CIRCUIT

1. Check Pin 12 of PLL chip for 10.24000MHz; \pm 100Hz.
2. Set channel selectors for Channel 80 (27.855MHz); in transmit mode: check/align if necessary the following: **CAUTION**, on 50 ohm load!
 - A. Connect VTVM between TP-1 and D.C. Ground, adjust L-203 for +5.5VDC if necessary! ..Leave meter in place at this time...
3. Set channel selectors for Channel 1 (26.515MHz); in receive mode: check for voltage reading between 0.3-2.8VDC..
(If the DC level stays between 5.5VDC at Transmit (27.855MHz); and 0.3-2.8VDC at Receive (26.515MHz); the VCO is properly aligned).
NOTE: Voltage swing determined by C-211 at factory, optimum value-100pf.

TRANSMITTER CIRCUITS

RF Driver Alignment: **CAUTION:** on 50 ohm load!

1. Set channel selectors for Channel 19 (27.185MHz). AM..
2. Connect O-scope to base of Q-301.
3. Adjust L-204, L-301, L-302 for maximum amplitude on display.
4. Connect O-scope to collector of Q-302.
5. Adjust L-303 for maximum amplitude on display.

RF Power Amplifier Alignment: **CAUTION:** in-line RF Watt Meter, on 50 ohm load!

1. Channel selector should still be at 27.185MHz - AM..
2. Adjust L-304, L-305, and L-306 for maximum RF power output.
3. "Touch-up Tune" the following for peak power: L-303, L-302, and L-301.
4. When all above are peaked, RF Meter should read above 4.0W.
Turn L-306; counterclockwise until the power reading of 4.0W is obtained.
(Note: Step 4, may be omitted - ED.)

Transmit Frequency Check: **CAUTION:** in-line RF Watt Meter, on 50 ohm load!

1. Connect Frequency Counter to load, or tab on RF Watt Meter.
2. Transmit mode, no modulation; check each channel's center frequency for tolerance: should be \pm 800Hz. (Check against Owner's Manual F_o Tables!)

Modulation Sensitivity Alignment: **CAUTION:** on 50 ohm load!

1. Apply 20mV, 1KHz signal to microphone input circuit.
2. AM mode - Transmit, and adjust RV-201 for 85% modulation.
3. Decrease signal level to 6mV, modulation level should stay above 60%.
4. Leave signal level at 6mV, 1KHz; go to FM mode - TX; adjust RV-501 for 1.7KHz deviation.

RF Meter Alignment: **CAUTION:** in-line RF Watt Meter, on 50 ohm load!

1. Adjust RV-202 so that meter pointer indicates the same as RF Watt Meter.
(Note: Have found it better to adjust half scale in AM TX, and leave it!)

*If you are going to change the RF Final to 2SC1307, do it before alignment!

RECEIVER CIRCUITS

Sensitivity Alignment:

1. Channel selectors to Channel 19 (27.185MHz), AM mode, Squelch Minimum.
2. Set Sig. Gen. at 27.185MHz; 1KHz, 30% modulation - insert signal at antenna connector. (Note: 3mV signal, do not overdrive the radio AGC circuits - just enough for accurate alignment)
3. Adj.: L-204, L-101, L-102, L-103, L-104, L-105, L-106, and L-107 for maximum audio output across an 8 ohm dummy load resistor. (If you don't have one-use radio's speaker in a pinch!)
4. Set Sig. Gen. for 27.185MHz; 1KHz with 1.7KHz deviation (Note: Step 2), Unit to FM mode.
5. Adjust L-501, T-501 for maximum audio output across 8 ohm dummy load.

Squelch Alignment:

1. Sig. Gen. to 27.185MHz; 1KHz 30% modulation - 54db output.
2. Squelch control fully clockwise, radio back to AM mode.
3. Temporarily adjust RV-101 for max audio out, note the level!
Re-adjust RV-101 for level decrease of 6DB..

S-Meter adjust:

1. Reset Sig. Gen. for 40db output signal, make no other changes.
2. Adjust RV-103 for meter indication of "s-9".

END OF ALIGNMENT...

uPD861 PLL - AM CHASSIS (UPDATE)

O.K.; questions are popping up all the time on this one; regarding Freq. going up instead of down. Here it is - 2 different chassis: 2-Crystal with Pins 7 and 8 at Logic-0; 3-Crystal with Pins 7 and 8 at Logic-1.

I only know of two 3-crystal chassis myself, both Realistics: Mils. TRC-424/431 (if anyone knows of more-pass on info.). These units go UP in frequency when modified 155KHz, DOWN to 25.045MHz. But keeping the power up across more than 1.2MHz bandwidth is another story.

The 2-crystal chassis doesn't go down; but UP -(way up)- 29.5MHz; (That figure is theory-wise!). Haven't worked on any, but VCO circuitry is less cluttered up and should have a wider bandwidth also.

One identical feature in both chassis is: Semi-potted VCO module, and that is where the VCO Varactor is! By removing it and replacing with a "Super Diode" should widen bandwidth - but is not an easy job. Don't recommend doing this unless you just have to have those extra Fo's..

ERRORS - NOT IN SCBI

1. SAMS #189, Page 85; Down Oscillator F_o Output of Q-805 is marked: (11.965MHz) above CT801. Wrong, change to 11.596MHz.
2. PLL DATA BOOK (Pub. by CB City) Pg. 26 - Re: '858' PLL drawing
Correct Pin 22 to P9, not Vss.
Pg. 27 - Re: '861' PLL specs.
'Internal Code Converter; delete ROM.

CONVERSION CHARTS

WAVELENGTH/FREQUENCY CONVERSION:

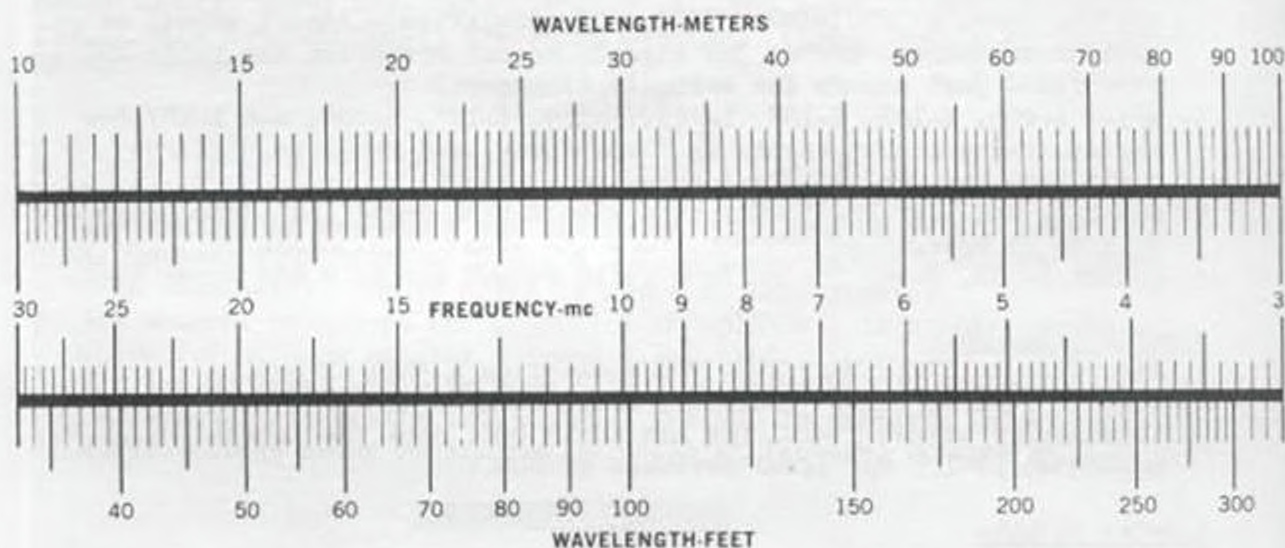

Wavelength-frequency conversion may be quickly made with chart above. Usefulness of chart is readily extended by using powers of 10 on coordinates. Example: F₀ scale (MHz) is multiplied by 10³ (for GHz), multiply wavelength scale (feet and meters) by the reciprocal of 10⁻³ (for millimeters). For Calculation: meters = 300,000/fKHz = 300/fMHz, or ft = 984,000/fKHz = 984/fMHz.

FREQUENCY BAND DESIGNATION

P-band	225-390 MHz
L-band	390-1550 MHz
S-band	1550-5200 MHz
C-band	5000-6500 MHz
X-band	5200-10,900 MHz
K-band	10,900-36,000 MHz
Q-band	36,000-46,000 MHz
V-band	46,000-56,000 MHz
VLF	to 30 kHz
LF	30-300 kHz
MF	300-3000 kHz
HF	3000-30,000 kHz
VHF	30,000 kHz-300 MHz
UHF	300-3000 MHz
SHF	3000-30,000 MHz
EHF	30,000-300,000 MHz

MB8719 with 11.1125 Crystal

Another diagram layout with: 41-44, & 10KC Flip-Flop....

Frequencies per selector chart was not sent in,

All connections are made directly to the PLL pins indicated, unless marked different.

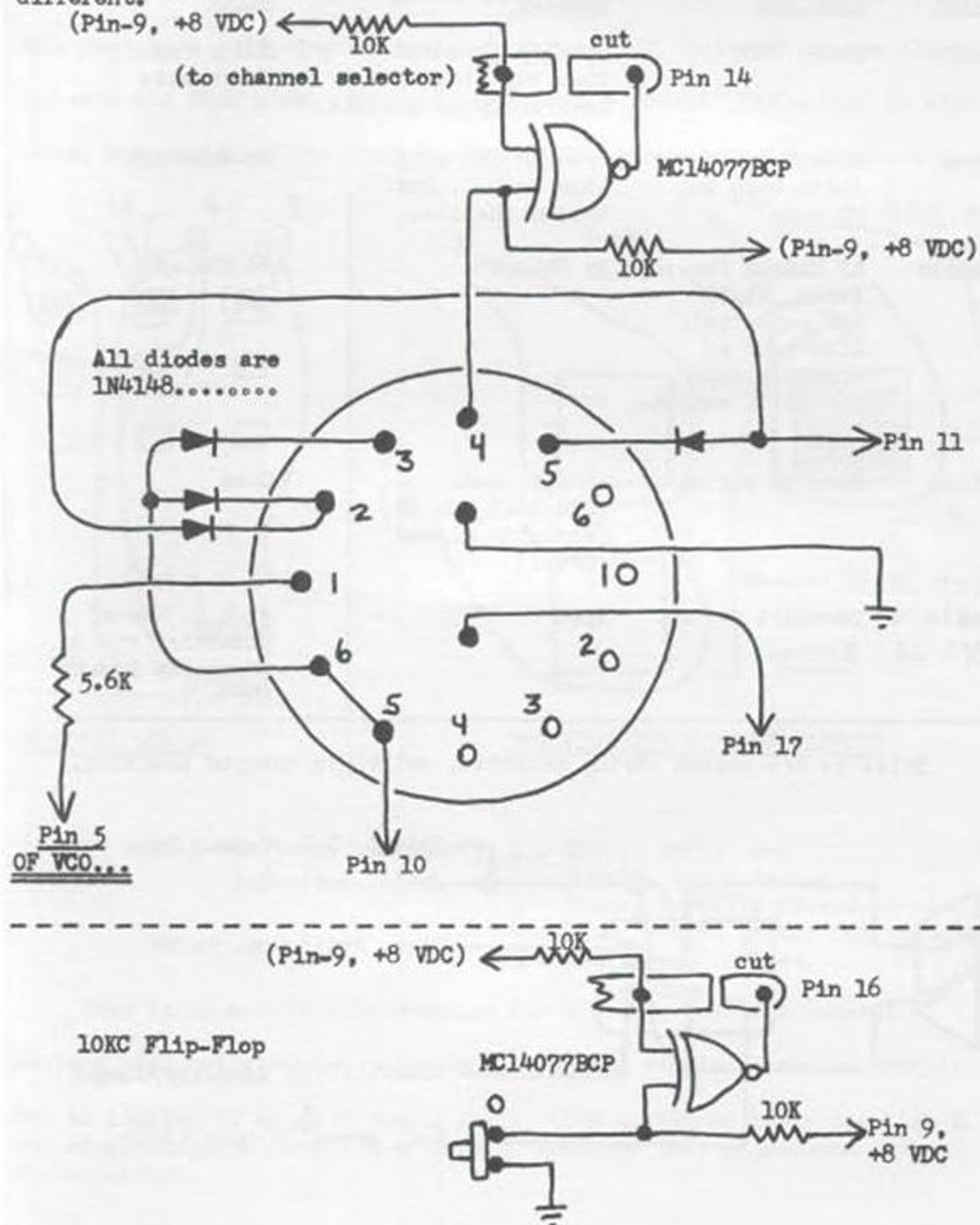

Radio Shack Mike Wiring

Converting Radio Shack hard/desk mikes is really no problem!

The 5 wires seem to throw everyone, especially their function as is:

<u>COLOR</u>	<u>FUNCTION</u>	<u>UNKEYED</u>	<u>KEYED</u>
White	Audio 'HOT'	Usually grounded thru the blue wire, internally on chassis.	Audio Input to chassis
Blue	Ground for Audio when in RX mode	Grounds the audio line to D.C. Gnd. inside chassis.	No Function
Shield	RF Shield for Audio, at DC Gnd potential. Also used as common ground for RX/TX switching.	No Change	No Change
Black	Receive Switch	At D.C. Gnd. potential via Sw. (Normally closed N/C..)	Open
Red	Transmit Switch	Open	At D.C. Ground potential via Sw. (Normally open N/O..)

Below is R/S switch wiring skematic, switch in unkeyed position.

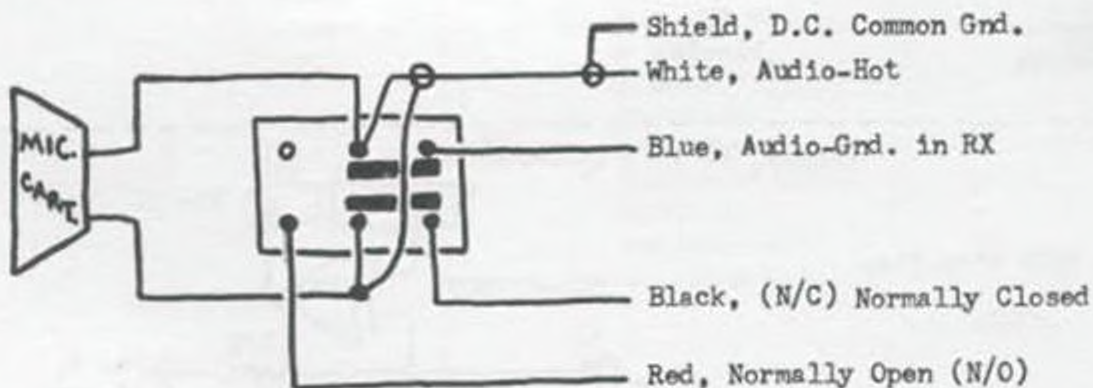

Radio Shack Mike Wiring (Cont.)

My idea of "Afternoon Delight" is not spending it on the phone; explaining how to wire a microphone! Especially R/S 21-1175 (Noise Cancelling Pre-Amp Microphone) to 5-pin President.

So, here it is: The President uses an "ungrounded" audio in receive, and shield is not a "common ground"..

Mike must have following changes made internally; cut etch in one place; and move the Blue wire. Then it works like a champ! Pin wiring is also below, with original/modified drawing of the microphone interior....

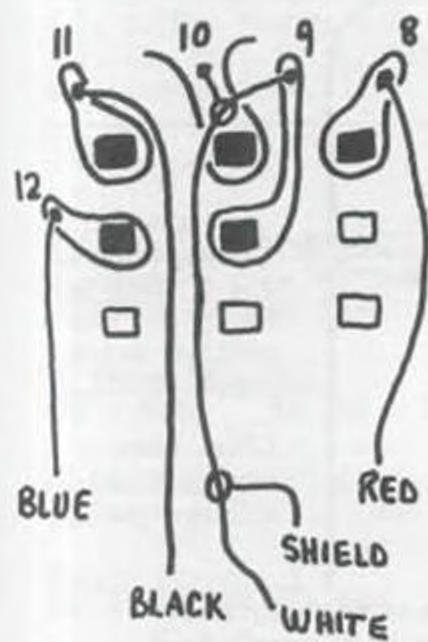

ORIGINAL WIRING

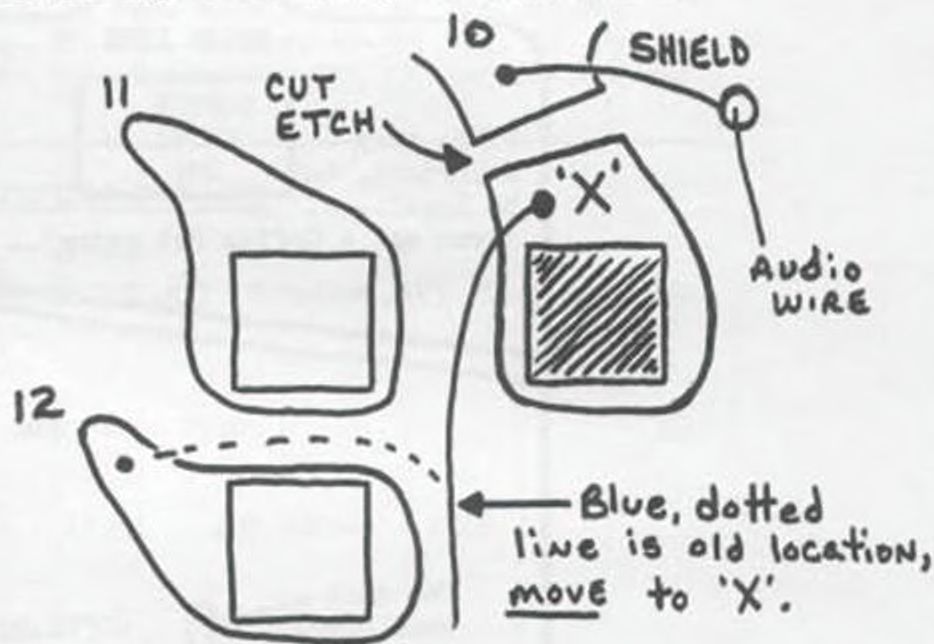

MODIFICATION WIRE CHANGE/CUT

New Pin Wiring for 5-Pin President:

- 1 - White, Audio - Hot
- 2 - Shield, Audio Ground
- 3 - Black, Normally Closed-shorted to Blue
- 4 - Blue, Common center for switching.
- 5 - Red, Normally Open..

This is an excellent microphone for SSB use, most independent dealers will not stock or recommend it for the simple reason-no profit!

Due to lagging CB sales by Radio Shack, (Due mostly to their own high \$, and discontinuance of SSB Base unit.) Look for this microphone to be dis-continued!

\$\$\$ MONEY - MAKER \$\$\$

I saw this very nice little item in North Dakota CB shop in December while on a hunting trip. Owner has it set up for quarters (25¢). Object is to drop a quarter in jar and have it land on the dowel.

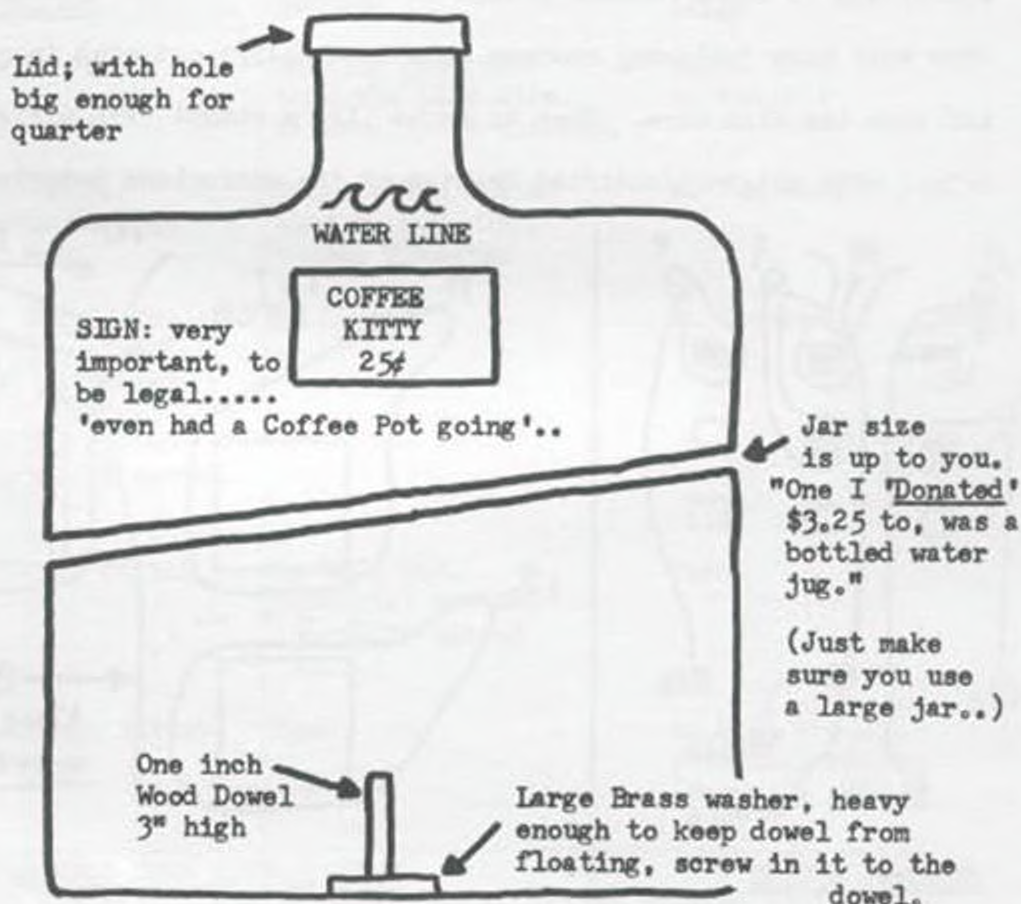

The "Coffee Kitty" in this case happens to be a new-in-box President Grant... Owner said he made 372 dollars over retail on the last unit.. Business picked up by over 100%, and the local bank has had to come to him more than once for quarters! To play it cool with the locals; sponsors 1 boy's baseball team, and girl's softball team; and does the local PD's radio work for parts.. Never could get out of him just how much he is making off the jug! I wouldn't tell either...\$\$\$\$

ANTENNA TUNING

Back to the old basics; seems people are still doing it wrong...
RULE OF THUMB (CUTTING-TUNING): If channel 1 reads high and channel 40 low - the tip is too short... If channel 40 reads high and channel 1 is low - the tip is too long...

EXCERPTS: Letters to Ed..

"Need a PLL/CRYSTAL Change for O2A AM Rig to obtain different Freq. Range"
ANS: See - Vol. 6, Pgs. 1-2; has O2A AM/SSB, 858 AM, 8719(Both Xtals), TC5080P, and more...

"Need a Power Change Mod. for DAK MK IX" ANS: See Vol. 5, Pgs. 21-23...

"Do you have any info. on Linear's, Troubleshooting?" ANS: YES-PLENTY...
See - Vol. 1, Pgs. 68-70; Vol. 3, Pgs. 66-76; Vol. 4, Pgs. 65-70;
Vol. 6, Pgs. 54-63; Vol. 7, Pg. 57; Vol. 8, Pgs. 47-50; Vol. 10, Pgs. 68-69;
Vol. 13, Pgs. 50-51. (Also see this Volume for Kit 137 information and more linear tips..)

SPECIFIC TUNE-UPS

Midland 77-808: PLL03A

TX-Peak I9, I8, I4. AMC-RV2 SQ.RNG-RV1 S-Meter..RV3 Tx-Meter..RV4
Unit has 29C1306 Final..pour it on..

JC Penry 981-6240

AMC - R212 AM PWR - I26 SSB PWR - R316

JC Penry 681-6241 & 981-8360

AM Power - RT602 SSB Power - RT701 AMC defeat - D406

Hvgain Hvrage V

AMC-RV7 SSB ALC-RV8 AM PWR-RV304 SSB PWR-I6, RV5

Royce 1-642 (Update)

Questions: What are the following adjustments, CT6 - SWR Meter Calibration.
VR9 - Transmit/RF Meter. VR13 - Driver Bias.

Cobra 19XS IC7131-PLL

New unit - has 29C2078 Final - push it; out of box units avg. 2W/40% mod.
No I.D. #'s on PCB, —see drawing below for adjustments.

Not to Scale

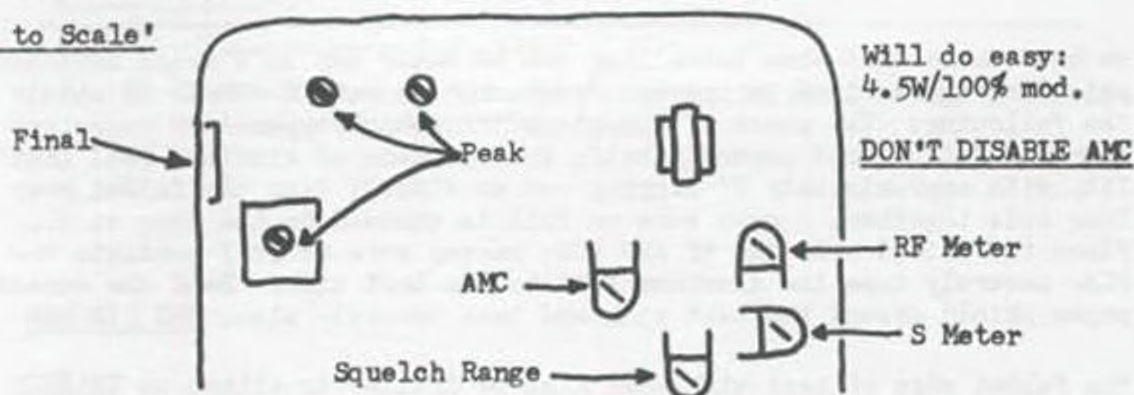

FOR USE ON 10 METER AMATEUR BAND ONLY...ILLEGAL ON 11 METER CB BAND..

Kit is furnished with Aluminum Heat Sink, and Factory Assembled/Tested RF Amplifier PCB.

Instructions:

1. Drill 2 holes in the Aluminum Heat Sink for mounting the Power Transistor. Use liberal amount of heat sink compound when mounting.
2. Connect RED wire to 13.8VDC/6 or 7 Amp source. (Note: Will probably have to use a separate switch for this; other than present ON/OFF switch; as the current required is higher than most set's capabilities.)
3. Connect BLACK wire to D.C. Ground.
4. An LED may be added for power indication. Solder the Anode to 13VDC source, Cathode to BLACK wire that goes to 330 ohm resistor.

Specifications:

A.M. - 4 Watts input; 35 Watts output, drives 55W PEP at 6 Amps.
S.S.B. - 12 Watts PEP input; 55W PEP output at 7 Amps.

————— HOOK-UP DRAWING —————

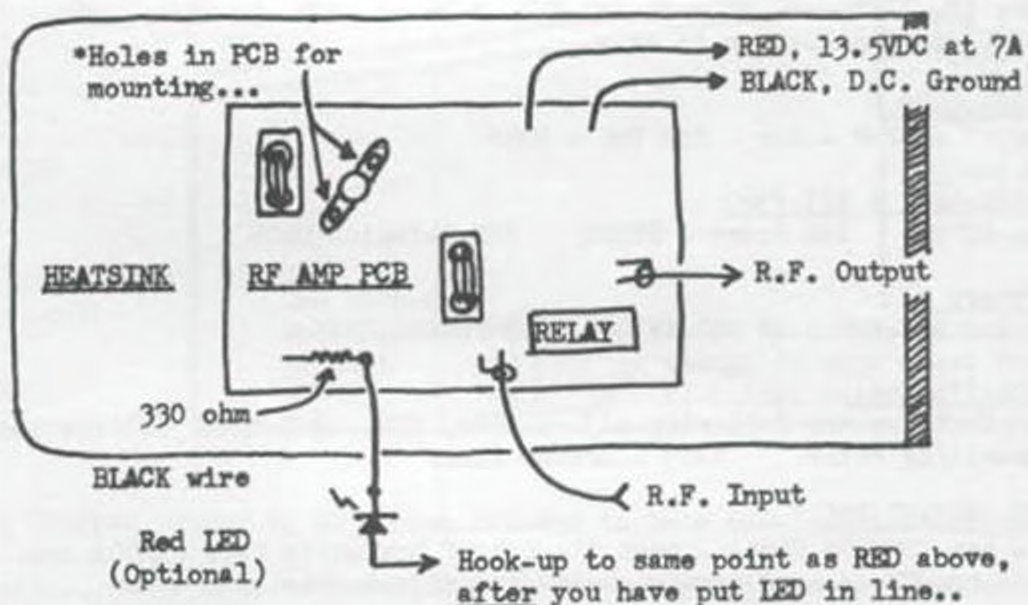

We have found that when installing the 10 Meter Amp in a radio additional shielding is required to prevent feedback. To make a simple RF shield do the following: Use piece of 'un-glazed' notebook/typewriter paper and aluminum foil. Fold paper in half; insert piece of aluminum foil (cut to fit, with approximately 2" hanging out on sides); tape the folded over long side together. - make sure no foil is exposed on the long side.. Place the shield over the RF AMP PCB; making sure no foil contacts the PCB; securely tape the aluminum foil to the heat sink. Bend the excess paper shield around the heat sink and tape securely also. SEE DIAGRAM

The folded edge of heat sink must also be drilled to attach to CHASSIS GROUND...

Shielding Diagrams:

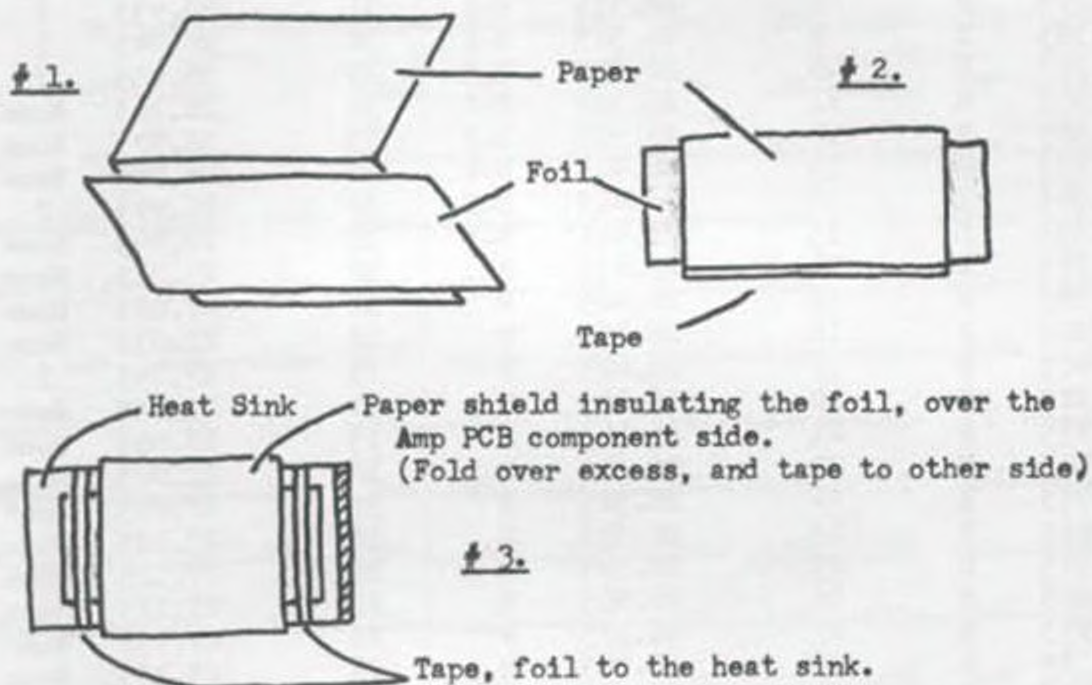

Suggested Wiring Hook-up.

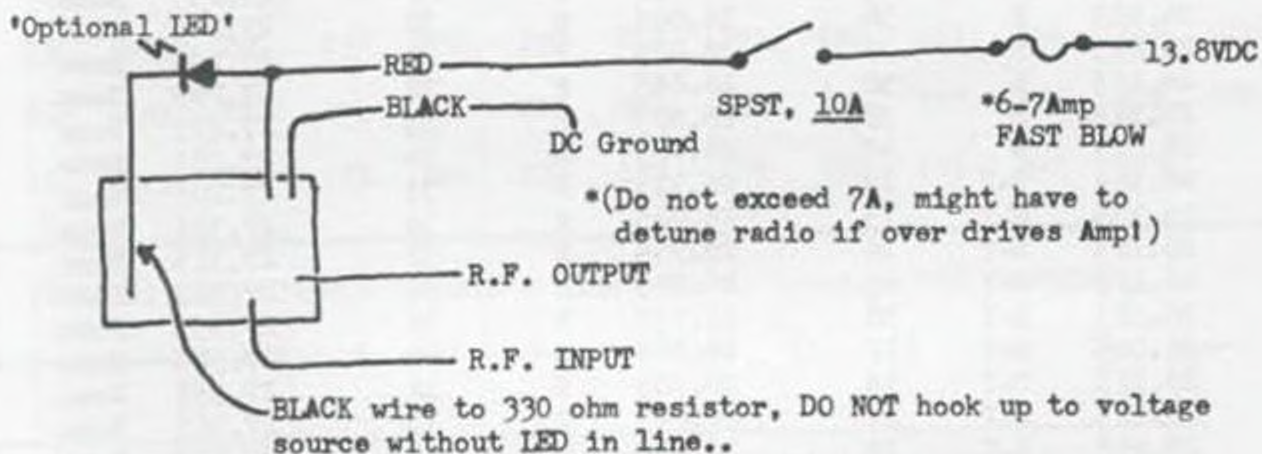

LARK Frequency Chart

Frequency	Code	Selector	Frequency	Code	Selector	Frequency	Code	Selector
25.685	B	1	26.285	B-Y	25	26.855	Y	18
25.695	B	2	26.295	B-Y	23	26.865	Y	19
25.705	B	3	26.305	B-Y	26	26.885	Y	20
25.725	B	4	26.315	B-Y	27	26.895	Y	21
25.735	B	5	26.325	B-Y	28	26.905	Y	22
25.745	B	6	26.335	B-Y	29	26.915	Y	24
25.755	B	7	26.345	B-Y	30	26.925	Y	25
25.775	B	8	26.355	B-Y	31	26.935	Y	23
25.785	B	9	26.365	B-Y	32	26.945	Y	26
25.795	B	10	26.375	B-Y	33	26.955	Y	27
25.805	B	11	26.385	B-Y	34	26.965	None	1
25.825	B	12	26.395	B-Y	35	26.975	None	2
25.835	B	13	26.405	B-Y	36	26.985	None	3
25.845	B	14	26.415	B-Y	37	26.995	Y	31
25.855	B	15	26.425	B-Y	38	27.005	None	4
25.875	B	16	26.435	R	10	27.015	None	5
25.885	B	17	26.445	R	11	27.025	None	6
25.895	B	18	26.465	R	12	27.035	None	7
25.905	B	19	26.475	R	13	27.045	Y	36
25.925	B	20	26.485	R	14	27.055	None	8
25.935	B	21	26.495	R	15	27.065	None	9
25.945	B	22	26.515	R	16	27.075	None	10
25.955	B	24	26.525	R	17	27.085	None	11
25.965	B	25	26.535	R	18	27.105	None	12
25.975	B	23	26.545	R	19	27.115	None	13
25.985	B	26	26.565	R	20	27.125	None	14
25.995	B	27	26.575	R	21	27.135	None	15
26.005	B	28	26.585	R	22	27.155	None	16
26.015	B	29	26.595	R	24	27.165	None	17
26.025	B	30	26.605	R	25	27.175	None	18
26.035	B	31	26.615	R	23	27.185	None	19
26.045	B	32	26.625	R	26	27.205	None	20
26.055	B	33	26.635	R	27	27.215	None	21
26.065	B	34	26.645	R	28	27.225	None	22
26.075	B	35	26.655	R	29	27.235	None	24
26.085	B	36	26.665	R	30	27.245	None	25
26.095	B	37	26.675	R	31	27.255	None	23
26.105	B	38	26.685	R	32	27.265	None	26
26.115	B	39	26.695	R	33	27.275	None	27
26.125	B	40	26.705	R	34	27.285	None	28
26.145	B-Y	12	26.715	R	35	27.295	None	29
26.155	B-Y	13	26.725	R	36	27.305	None	30
26.165	B-Y	14	26.735	R	37	27.315	None	31
26.175	B-Y	15	26.745	R	38	27.325	None	32
26.195	B-Y	16	26.755	R	39	27.335	None	33
26.205	B-Y	17	26.765	R	40	27.345	None	34
26.215	B-Y	18	26.785	Y	12	27.355	None	35
26.225	B-Y	19	26.795	Y	13	27.365	None	36
26.245	B-Y	20	26.805	Y	14	27.375	None	37
26.255	B-Y	21	26.815	Y	15	27.385	None	38
26.265	B-Y	22	26.835	Y	16	27.395	None	39
26.275	B-Y	24	26.845	Y	17	27.405	None	40

Yep! Another Freq. Code: This is AM also - had chance to check this one out with dummy load and on the air. (But couldn't take covers off, as sealed). 02A chassis; power flat from 25.755 to 27.405, 100% + modulation, excellent receive..will find out who built and try to have info for Vol. 19; as this is definitely an excellent and useful Freq. modification for AM rigs.

(UPDATE) SAMS CB MANUALS - Line thru #, denotes: OUT OF PRINT...

1	2	3	4	5	6	7	8	9	10	11	12	13	14
15	16	17	18	19	20	21	22	23	24	25	26	27	28
29	30	31	32	33	34	35	36	37	38	39	40	41	42
43	44	45	46	47	48	49	50	51	52	53	54	55	56
57	58	59	60	61	62	63	64	65	66	67	68	69	70
71	72	73	74	75	76	77	78	79	80	81	82	83	84
85	86	87	88	89	90	91	92	93	94	95	96	97	98
99	100	101	102	103	104	105	106	107	108	109	110	111	112
113	114	115	116	117	118	119	120	121	122	123	124	125	126
127	128	129	130	131	132	133	134	135	136	137	138	139	140
141	142	143	144	145	146	147	148	149	150	151	152	153	154
155	156	157	158	159	160	161	162	163	164	165	166	167	168
169	170	171	172	173	174	175	176	177	178	179	180	181	182
183	184	185	186	187	188	189	190	191	192	193	194	195	196
197	198	199	200	201	202	203	204	205	206	207	208	209	210
211	212	213	214	215	216	217	218	219	220	221	222	223	224
225	226	227	228	229	230	231	232	233	234	235	236	237	238
239	240	241	242	243	244	245	246	247	248	249	250	251	252
253	254	255	256	257	258	259	260	261	262	263	264	265	266
267	268	269	270	271	272	273	274	275	276	277	278	279	280
281	282	283	284	285	286	287	288	289	290	291	292	293	

(UPDATE) SAMS SCANNER MANUALS - Line thru #, denotes: OUT OF PRINT...

1	2	3	4	5	6	7	8	9	10	11	12	13	14	15
--------------	--------------	--------------	--------------	--------------	---	--------------	--------------	--------------	---------------	----	----	---------------	----	---------------

Above chart accurate thru Jan. 1984. If you are missing/need any-GOOD LUCK..
Don't be surprised to see Out-Of-Print volumes going for \$12.00 +, USED !
(Average range is \$12 for CB, and \$20 for Scanner volumes)

ANOTHER - PLL02A AM MOD?

YEP..! BUT, this one is for those units you may have run across that won't work on the standard 02A AM mod. - These 'units' are the "3 crystal 02A chassis"; really were 'left-overs'; factory-converted from 23 channel to 40 channel. (Standard 02A AM mod. works only on the 2 crystal 02A chassis which is the 'true 40 channel chassis'.... NOTE: SCB Kits #'s 83-1 and 83-2, will work only on the 2 crystal chassis.)

'Factory converted' units are easy to spot from the 3 crystals, and the etch being cut on bottom of PCB under the PLL chip. Known units at this time are: HYGAIN Mils. 2679, 2679A, 2682, 2701; PEARCE-SIMPSON - Tiger 40A; if anyone runs into any additional units pass the Brand/Mil.# on...

You will immediately notice that PLL pins 8, 9, and 10 are tied together. Pin 10 has to be completely isolated for low frequencies.

- To modify for LOW Fo's, follow instructions and use drawing below:
1. Remove wire running from the channel selector to Pin 10 of the PLL chip at the PCB end.
 2. Completely isolate Pin 10 of the PLL chip by cutting the etch as shown in drawing.
 3. Use an existing 'cleaned-off' switch that has been hard-wired or a DPDT switch, and wire up per drawing.

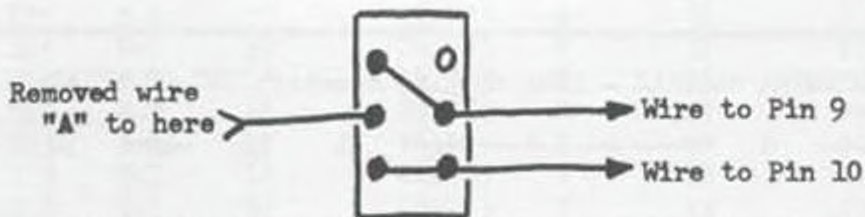
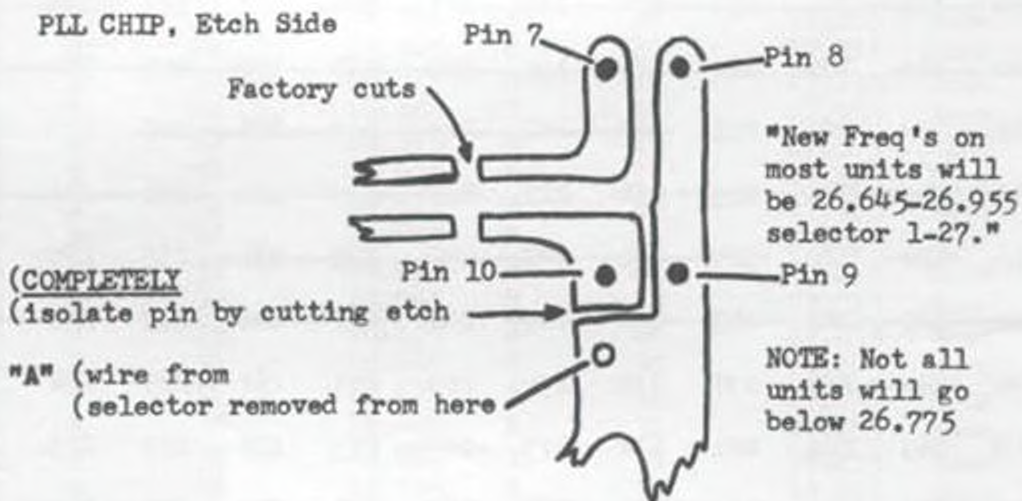

Realign PLL ckts for overall frequency spread in this order: T101, T111. For overall broadbanding tune for RF output power: L103, L104, T102, T103, L106, L109, L110. (These units usually have a 2SC1306 Final, so pour it on.) NOTE: See Vol. 15, Pg.65; for Power Modification of this unit.....OMIT STEP 8....of the write up!!
If you need more modulation, remove C209; first adjust AMC-RV102!

Received a call from local TV shop last week offering me 6 color TV's - no charge, just haul away. I figured out that they were cleaning house on all their 'junkers' again; but went down to pick up anyway; as might pick up some spare parts for my own TV's. Surprise!

Reason for getting rid of them: Repair bill's too high and customer's didn't want sets if that was what it was going to cost. So they pulled the tubes out and said to H___ with it. Tubes worth more than the sets anyway and nobody would buy for the repair bills!

If you haven't checked the prices on tubes lately, do it!..... Tubes went up in price Oct '83, and scheduled for another increase in March '84. At present time: 6DS4 - \$33.35, 6GH8 - \$11.40, 6BQ5 - \$14.95, and 6JE6/6IQ6 - \$29.50 ...Retail! Can make a fortune selling at 1/2 price! Anyway, about 6 years ago I did some insurance work after the big HERricane tore up the S.E., starting in Mobile and going North. Bought 4 complete TV shops at 1¢ on the \$ average. Sold off everything at auction; but kept the tubes: wore out the sockets in two tube checkers. (After cleaning the mud off them!) WARNING: Check the tubes first to see if the type is acid etched on the glass - then you can put in water. I had my nephew clean them for me when I wasn't around, and lost about 20% (No I.D.)....

But - back to the TV's, fixed 5 I had tubes for and sold 4 for \$85 each with standard warranty (2 steps out the door)! The 5th I donated to Salvation Army for a \$225 tax write-off; complete with paperwork on Lifetime PictureTube Warranty (25" XL-100 Console). Ran into problem with the clean unit I wanted to keep, didn't have one tube - \$29.95...

Went back to TV shop and bought the tube, but owner made me a better deal! Trade me the tube for labor bill on a scanner repair; an old ACT-10 H/L/U Regency; DEAL... Fixed scanner in 20 minutes and took back. He got a little hot when I told him the trouble; someone had filled it with Bearcat Crystals and still couldn't program it right; or put them in the right sockets! Put 3 local police Fo's in it, and said HO-HO-HO Merry Christmas! Seems he had paid \$120 for it, got burned-only worth \$70 full of Xtals. ...Grandma got a 15" Color with Remote for all the trouble; in better shape than when left the factory; as this had tuner rebuilt by PTS also.

What I am trying to get across is that those tubes you have been throwing around are going to be worth a small fortune. I have mine inventoried and whenever a price change comes in, refigure their total retail value. Last change I made \$5,270.45; ON PAPER; and don't even have to feed them/don't talk back/just sit there making money!!!

Ed. Note: Hope I got his point across correctly...Scrounge, before it's too late and everyone gets the idea. Been doing it for years myself, but go one step further. Those small screen TV's are too expensive to repair, and Pix Tubes are expensive (5"-9"). Have about 60+ of them, just for replacing in those AC/DC/Battery sets. Come hunting season, sell the H___ out of them! \$\$\$

SPECIFIC TUNE-UPS

Sears 23; 934.36740500Modulation Limiter, Disable D-10

Kraco KCB 1401, 23ch. VR7-AMC, VR3-Rx Mtr, VR8-RF Gain, VR5-Sq. Rng..
VR2-Tx Mtr. Tune for max forward mod. L11/10/9.

Sharp 2460 (Sams 172) AMC disable - D-101...

Picked one questionnaire for publishing; as it was typed; and has the Q's..

Have broken down the survey to the most prevalent Model or Chassis type in order.. This way gave a broad band, but excludes those under a 5% choice.

1. Volumes - 50% all...
2. Mobile AM - 02A Chassis; Mobile SSB - 858 Chassis; Base AM - 02A Chassis; Base SSB - SHOCKER TRC-457 (75%), then 8719 Cobra/President.
3. Cobra 2000 (70%), then 02A SSB 2-board Chassis, 02A SSB Chassis, Tram.
4. 148GTL-DX (95% +), Stalker 9-DX the only other unit to be close.
5. Palomar 2400, Tristar 747, top two.
6. Most had both AM and SSB unit. 02A-AM, 858-SSB units leading by wide margin over 8719 chassis and various others. For Freq. ranges see other sheet as all fell within his range? Microphone: Mobile - between Turner and R/S 21-1175; Base - Turner and Shure. Antenna: Mobile - Bandit, K-40, 102" whip; Omni - Big Stick, Penetrator; Beam - Gizmotchy, Y-Quad.
7. 858 SSB units topped them all, then came 148GTL-DX. WHO put a Royce?
8. President Adams top by 65%, then came 148GTL-DX again.
9. Useage averaged out: AM - 20%; SSB - 70%; FM - 10%.
10. Yes, (I do - 75%); surprise...
11. Yes - 70%, Sometimes? - 10%, No - 20%.
12. Weird answers on this one (someone said his 858 SSB chassis was refused?). Can't see that unless was butchered up...Leading the list was 02A SSB 2-board chassis, then Royce, Pace, Robyn, Johnson, combination units.
13. Yes - 90%; remainder were 'Yes, and other sources.' One exception, "NO, I am blind!" (this person also said was operating Zebra Alpha unit!)
14. Price spreads given: SWR \$4-7; MIKE \$4-10; AM MOBILE \$15-25; AM BASE \$18.5-25; AM/FM/CB \$20-45; SSB MOBILE \$18.5-50; SSB BASE \$19-75; ANTENNA MOBILE \$10-25; OMNI \$15-50; BEAM \$25-50.
15. AM - 02A, SSB - 858, both by so wide a margin - won't mention others!
16. AM - Royce, Robyn, Johnson were tops - along with combination units. SSB - 02A 2-board chassis and Johnson again (must be those 4730's)
17. Quotes \$10-20, also "don't give, unit is fixed or not!"
18. Averages: AM 20-40%, SSB 60-80%.
19. Kit Avg. MINIMUM: AM Mob. \$15-25; AM Base \$20-25; SSB Mob. \$22.5-50; SSB Base \$23.5-50.
20. Custom Avg. MINIMUM: AM Mob. \$12.5-40; AM Base \$12.5-50; SSB Mob. \$13.5-75; SSB Base \$13.5-75.
21. 858 SSB, 02A AM, 02A SSB, 8719, mix of others.....
22. Yes! Parts, Labor, type of unit, modification, and what the market will bear!
23. Mobile: for all purpose tied; Bardit, K-40, 102" whip.. Base Omni: Super Penetrator, Starduster. Base Beam: Moonraker-4, PDL-2.
24. Mobile: Turner, R/S 21-1175. Base: Turner and Shure, Astatic close 2nd.
25. In order of complaints! 02A 2-board, Royce, Combo's, Johnson, Sears(3827).
26. Stupid Design, in order: 02A 2-board, Royce, Johnson, Robyn(PLL).
- 27 & 28, A lot of people got mixed up, meant CB Manu., not part's houses! DROPPED
29. 100%, NO!
30. Mike/cable, Finals, bad part, "Golden Screwdriver Damage".
31. Seal - Yes, 100%....still work on - No, 100%....
32. Appointment, 65% - Yes. While you wait, 85% - No. (exceptions were PD/Fire)!
33. Pick-up time: 5-45 days. Sell: 100%, Yes...
34. Yes; especially line-ups, tune-ups, schematics, who does the writing?
35. 100%, YES.....

1. How many volumes of Secret CB do you possess? 17
2. In your opinion the best CB built to date (exclude EXPORT)
Mobile: AM 02A SSB ADAMS Base: AM None SSB ADAMS on P/S1
3. The most over-rated/priced unit built to date: Cobra 2000
4. In your opinion the best "EXPORT" CB: 148GTL-DX, before price jacked up!
5. The most over-rated/priced "EXPORT" CB: Palomar 2400 - a joke \$450
6. If you own a "converted" unit: AM X SSB X Brand: 02A-AM, ADAMS-SSB
Kit conversion "Custom" conversion X Do you own more than one: 4
Freq. Ranges of operation: 24.650-31.300MHz 131-165 MHz Also...
Microphone used: Mobile R/S 21-1175 Base Expander 500
Antenna used: Mobile Bandit Base: Omni Custom #3#3#3# made
7. Radio/s you own that will not sell: None
8. If you had your choice which radio would you own: Another Adams!
9. Which do you use most: AM 20% SSB 75% FM 5%
10. If you had the capability would you use FM? I do - yes!
11. Do you use RF Power Amplifiers (Linear)? NO, wish they all blew up!
12. Have you had people refuse to work on your CB, if so what type
13. TECHS: Do you use 'Secret CB' as a reference in your work? Yes
14. Minimum labor Only, for following services: Check SWR \$7 Rewire Mike
Conn \$7 Repair - AM Mobile \$15 AM Base \$20 AM/FM/CB \$45
SSB Mobile \$30 SSB Base \$35 . Antenna Installation - Mobile
Base Omni Base Beam DO NO ANTENNA WORK
15. Easiest Chassis to work on: AM 02A SSB 858 & 02A Single Brd.
16. Worst Chassis to work on: AM R/S Tele-type SSB 02A - 2 board chassis
17. Price for a repair Quote: AM No quotes given, I fix it or forget it.
18. Percentage of repairs: AM 20 SSB 80
19. Minimum price for kit conversion (+ kit): AM Mobile \$15 AM Base \$20
SSB Mobile \$30 SSB Base \$35 (Kits installed using existing Sw.s
20. Minimum price for "Custom" Conversion: AM Mobile \$40 AM Base \$50 Only
SSB Mobile \$60 SSB Base \$70
21. If you specialise on one type of chassis: 02A-AM, 858-SSB, 02A Single Brd.
22. Do you build/sell your own 'converted units'? If so what is final price
dependent upon? Exterior condition, Freq Rng, Amount of 'extras',
All are custom built using existing switches, jacks. \$300 Min.
23. Antenna recommended: Mobile Bandit Base Omni None Beam None
24. Microphone recommended: Mobile R/S 21-1175 Base Expander 500
25. What units will you not work on: 02A 2-board SSB, Combo with Tape
26. Stupidest designed unit, by repair access: 02A 2-board
27. Company with best R/S, Unid., worst Cobra response on parts.
28. Company with fairest Uniden, R/S, ridiculous Cobra prices on parts.
29. Do you make your living on CB Sales/Repairs? No - in ECM field
30. Most common reasons for repairs, 3 top: Screwdriver Jock's,
Neophyte Repairmen (easy to spot with holes drilled in back)
31. Do you seal after repair Yes!, if busted do you still work on NA
32. Repairs by appointment Yes, repairs while you wait Police only!
33. Time limit on repair pickup 5 days, sell units not picked up on time YES
34. Has format change in "Secret CB", since Vol. 16 helped you in your work,
and why Yes, more information and more technical on drawings,
skematics are a great help.
35. Would a "Newsletter" (sort of Wanted/Trade/Sell; units and especially parts
be of value in your work? Yes - have a lot of stuff to trade or
sell, and need stuff also....

(Ed. Note:) Survey results were impressive. If you didn't participate, what can I say? Some of the answers I agreed with; others - well; to each his own.... It was no surprise to find the 858 SSB and 02A AM chassis on top, but the 148GTL-DX is closing ground! The minimum labor prices were a shocker, especially \$13.50 for a 'Custom Conversion' on SSB chassis! (I hope that included a 'Pink power cord with Yellow Polka-Dots', ??) Around my neck-of-the-woods, that price won't even get it on the bench! If we run another survey will be a different format, as had a H of a time with computer..... 51 participants in this survey???

SAVE THE CHIP - MAYBE YOUR METER!

Was asked to try fixing a Beckman DVM by friend at local TV shop, zapped it when probe tip slipped and hit a 400V line. Told him to ship it back for repair; as Beckman makes their own chips; bill came to \$51.84..

I had 3 sets of 'homemade' probe tip inserts that I made over 20 yrs. ago, and gave him a set. Said He'd never seen anything on the market like these; and wanted 6 more sets of them; if I could make them up. He paid for parts, and whipped them out during Monday Night Football. Total 'dealer cost' for parts was \$9.87.....used all new parts, but could be made for less with 'junk box parts'. Some manufacturer will probably come out with them at \$9.95/pair, molded connections-so when/if they bust will have to buy new ones....BUILD YOUR OWN.....

- Parts list per pair: 2-(1 ea) Metal-Clad Tip Jacks (Mil. Spec.)
E.F. Johnson #105-0202-200, Red Tip
#105-0203-200, Black Tip
1-Sewing Needle, make sure is long enough,
(minimum 1½", and has large eye).
1-Mueller Mini-Gator Clip #30-C, and Vinyl boot
#32, Black.
5"-Solid Buss wire "pretinned copper" 24ga.,
R/S #278-1341 or Belden #8022.
Misc. pieces of heat shrink, and 1½" of Teflon
sleeving (I.D. size of the needle).

Assembly-Red Tip Jack:
(Remove washer & Nut)

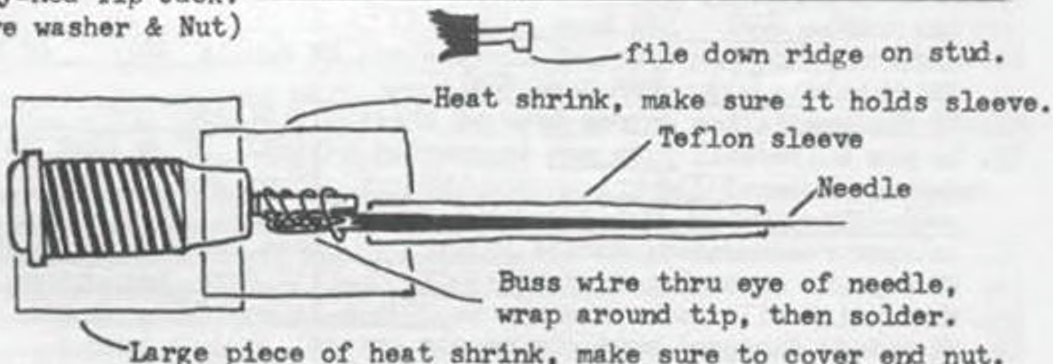

Assembly-Black Tip Jack:
(Remove washer & Nut) "Do not file ridge on stud"

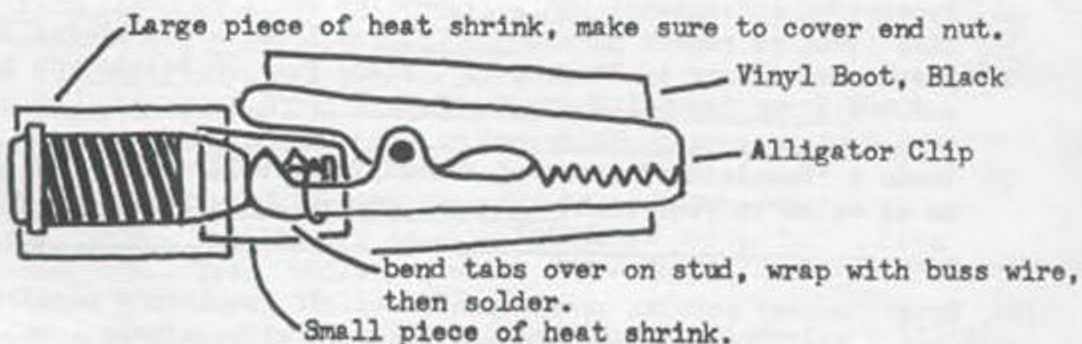

Now, probe around all you want, no more slipping off...

REMOTE CONTROL OF AMPLIFIER

Had a problem! No room to install RF Amp in car under the dash. So came up with a way to control the unit with a remote switching box, with indicators for each function. Installed the amp where I wanted and also couldn't be seen.

This design is also adaptable to any device for remote operation if controlled by D.C. switches for On/Off operations.

All you have to do is wire up another set of switches exactly like the originals, but add one set of switch functions for indicators to each. All interconnections are point to point wiring, color coded wiring is suggested with large ribbon wire for current loads.

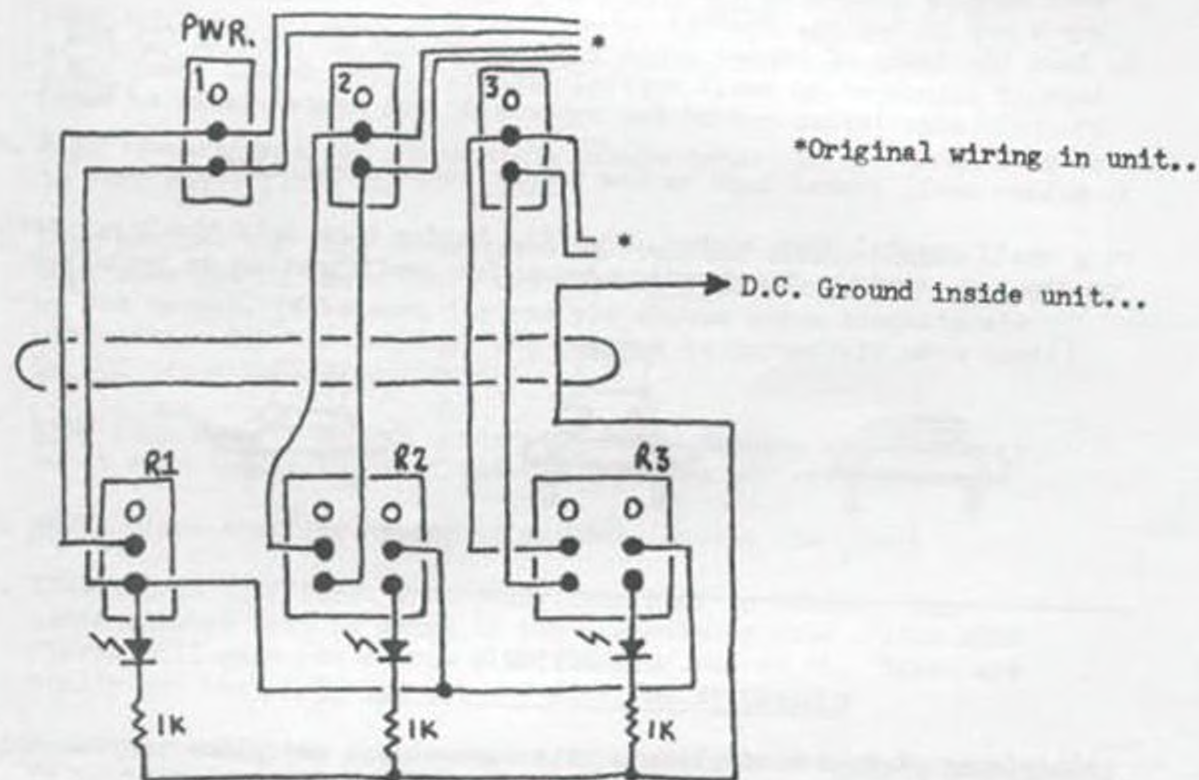

Note: Switch R1; this does not have an added section; isn't needed for the main power switch. R2 and R3 do have the added section for indication lamp circuit.

My remote switching unit was built in a small Digital Display case found at local R/S. LED's were mounted above switches on the RED Plastic bezel of case, all wiring was point to point.

Operation is simple: turn off all switches on original and operate from remote. Each individual unit is more or less 'custom built' due to different designs.

THINK SMALL! 1 - 2 - 3

Those older type units you probably have laying around because of the cost of replacement crystals - get them out and go to work....

Most early CB and Scanners both, used the large plug-in type HC-6/U crystals. You probably left the bad ones in; just in case for reference; and hope of finding another cheap..

Do it the easy way if you have the smaller size plug-in crystal with the equivalent frequency.

1. Unsolder the old can from the header of the bad crystal. Clean off the old crystal and wires (by the way those little wires to the crystal were usually GOLD...so collect a few million and you can then afford to buy a cup of coffee, MAYBE!)
2. Bend the leads of header where you removed the crystal to fit the legs of scrounged-up small crystal socket. (look in all those old 23-chnl. rigs laying around for sockets.) Cut header leads as short as possible.
3. Solder small socket legs to the header leads carefully!

Plug small crystal into socket, then the header back into the large socket. 'On the Air, again' See drawings below for amplification on building:



- - CORRECTION - -
MIDLAND 79-900, SCB Vol. 5, Pg. 47

(Permission granted to duplicate this correction, and place in your Vol. 5)

Change/replace: Paragraph 1, and drawing with corrections below....

1. Clip Gray wire at bottom of clarifier control and tape back. Run a wire from this point to Pin 1 of IC-6 (MB3756). Clip Blue wire at center of clarifier control and tape back. Unsolder Blue wire from PCB 343AA and connect to center of clarifier control (see diagram). Remove D-39 (next to VR-5). To use fine tune on mic gain: desolder Green wire at PCB 343AA (see diagram), and connect with Orange wire at top of clarifier control. This will allow approximately ± 2.5 KHz slide from center frequency using radio Coarse tune.

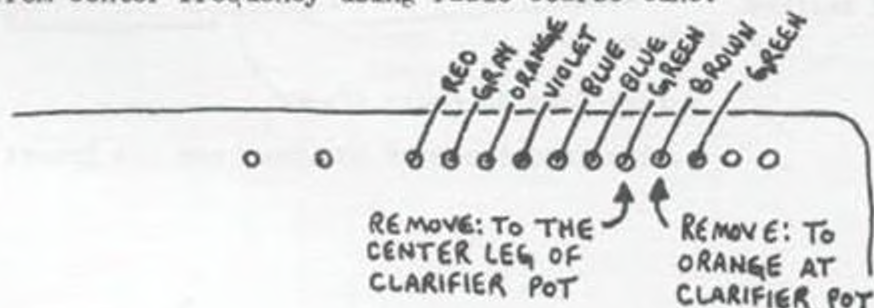

1. NEVER touch the tape itself.
2. When not in use, store tape upright in container provided.
3. Keep container/tape away from heat, and magnetic influence.
(Ed.Note: Store up high-away from where a Vacuum Cleaner might mess up the taped material!)
4. Always rewind tape before removing from machine. (If you don't want to rewind..carefully push the eject; while holding finger over the housing; then ease off gently..in this manner the lid of video cassette doesn't flip down immediately and catch the tape.)
5. High temperatures can permanently damage tape! Do not store in your car's glove box or trunk.
6. Keep machine and tape cassettes dust free and clean. Store tape when not in use. There are several good covers for machines on the market. (Make sure the one you choose gives adequate air circulation for the machine, and machine is turned off when used!) DO NOT use a towel for a cover!
7. READ your Owner's Manual concerning DEW! Machine and tape must be at room temperature; if not - a tape jam may result!
8. NEVER place anything on top of machine, except the cover.
9. Always push STOP first when going from PLAY to REWIND. Any sudden change that is going to put a strain on tape - push STOP first, will save you a tape plus whatever was on it. Tapes are really not that fragile, but the material on them is!
10. Note: Most machines put a snap on tape when the rewind is completed. To avoid this - watch the tape; when it gets down to near the end; push STOP - then PLAY - then REVERSE SEARCH. This way gently rewinds and shuts off when getting to the end. (Not all machines have this capability, so won't have this choice)
11. If you happen to break a tape, don't take apart to fix it yourself! Most manufacturers will replace it free of charge, if you mail it to them. If your machine breaks more than one tape in a row - get a service shop to look at it...(In 4 years have only had one broken!)
12. Keep children away from machine and tapes, not a toy! Have seen machines in repair for: Soda Pop, Toy Soldiers, Chewing Gum, Marbles, and even a Chicken Leg Bone!

WARNING: COPYING OF COPYRIGHTED MATERIAL IS STRICTLY ILLEGAL.....

If you are going to make a copy of television program. Set machine to FASTEST recording speed and tape everything including commercials; if you are going to need more tape for an extra long program; change it during a commercial - don't bother rewinding as can do it later! Many times material has been lost by people forgetting the Pause button and the machine shuts itself off. (Write down the edit points on a piece of paper and edit when making your permanent copy at the SLOWEST recording speed.

When copying an original tape make sure you edit out the "WARNING", and name of company producing it.

In 98% of cases can usually 'dub/copy' originals with excellent results by using a "special" set of cables. (These will not be found on the dealers shelves...! They are in the business of selling 'Gadgets' that are not necessary-for a huge profit and cost to you...!)

These "Cables" are an underground item and hard to find, cost is usually about \$20 + per pair. (Whoever provided you with this copy can probably get you a pair, - note: do not try to use just one, get the set...!) When you get them, unkink and lay out flat for a couple of days. When not using store in a wide loop and in plastic sealable bag.

NOTE: I have seen an 8 hr. tape made of cartoons that looked original, a copy was made of this "Master Copy", and was even impressed further by the quality.

In ALL cases when making a copy of original or a "Master Copy", use the slowest speed...It is hard to get into people's mind that it makes a better copy...!

Follow the diagram below EXACTLY when making copies. It is very important that these are the ONLY wires hooked up.

1. Receive Machine (Copier..set SLOWEST copying speed; usually ESP or SIP. 'Tracking' to middle position-leave alone. Set tuner to any un-used channel in your area.)
2. Transmit Machine (Original material or copy to be transferred to a "Master Copy". Turn modulator off - usually a button called TV/VCR. Run off a few feet of material and adjust the tracking on this machine for best picture on the TV/Monitor.)
3. Run off a short copy using both machines. Stop-rewind and check your copy's quality; might have to readjust tracking slightly-this will happen only in rare cases and then only those tapes having a heavy "Copy-Guard". Rewind both tapes after checking copy and go for it! (Remember when finished with copying; break the tab off the cassette; to prevent the accidental erasure of material.)

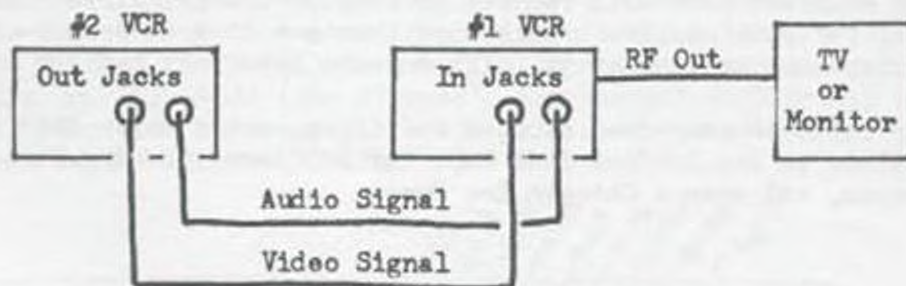

(*) This amplified article of SCB #17 is for the many requests we have had pertaining to the hook-up...ALSO the cables, patience-as we are now stocking-and availability is limited at times....

VCR/TV TIPS

Trouble with 'Flagging' or 'Bending of Picture' at top of screen?

This is a common problem on some of the older 'tube/hybrid' sets when using a VCR. Some of the most common immediate cures are listed below:

1. Change the Sync tube; to same type or high Mu type. (Mu means gain).
 2. Change the Dual Diode; (Horizontal Phase Detector).
 3. Change the Video Detector Diode/Tube. (Hybrid sets will have the Diode)!
 4. As a last resort; you will have to go into the TV's AFC circuitry and change components in the integrating circuit. (Not for the novice; have a GOOD T.V. bench man do this for you; NOT a tube jockey!)
-

SPECIFIC TUNE-UPS

GE 3-5806: S Mtr-RV1, RF Mtr-RV2, Sq Rng-RV3, AMC defeat-Q7
Tx adj: L9, L11, L12. Rx adj: L1, L2, L3... PLL Type?

Courier Rebel 23+: S Mtr-VR7, Sq Rng-VR3, RF Mtr-VR6
Tx adj: T15, T16, T17, L13, L12, L9.
Rx adj: T8, T7, T6, T5, T4, T3, T1, T11, T12, T13, T14.

Courier Traveller II: S Mtr-VR3, Sq Rng-VR5, AMC VR6
Tx adj: L12, L13, L14, L15, L16, L18, L20
Rx adj: L10, L9, L8, L7, L6, L5, L3, L2, L1

Courier Conqueror & Caravelle: S Mtr-VR2, RF Mtr-VR1, Sq Rng-VR3, AMC-VR6
Tx adj: T20, L3, L2
Rx adj: T5, T6, T7, T1, T2, T3, T4

Courier Comet 23: Sq Rng-VR202, RF Mtr-VR201.
Rx adj: T201, T106, T104, T102, T101
Tx adj: T108, T109, T110, T111, T204, T205, L202

Courier Chief 23: Sq Rng-VR202. Tx adj: L202, T205, T204, T111, T110, T109.
Rx adj: T201, T106, T105, T104, T103, T102, T101, T205.

Courier Classic II: P/S VDC adj-R709, S Mtr-R519, Sq Rng-R511, AGC-R306,
RF Mtr-R521, AMC-R715. Rx adj: T2, T1, L4, L2, L1.
Tx adj: L8, L9, L10, L11, C934, L14, L15.

Courier Classic III: P/S VDC adj-R728, AGC-R305, S Mtr-R518, Sq Rng-R507,
RF Mtr-R517, AMC-R593.
Tx adj: L905, L906, L907, L908, L912, L913
Rx adj: L101, T301, T302, T304, T305, T306

Great GT-838: S Mtr-SRV1, RF Mtr-SRV3, Sq Rng-SRV2. (AMC defeat, Collector of Q-9).. Rx adj: L1, T1, T2, T3.
Tx adj: T5, L5, T202, T203, T204, T205

Unimetrics Dolphone: VR3-Sq Rng, VR4-AMC, Rx: L9, L10, L11, L12, L13, L14, L15, L16. Tx: L2, L3, L4, L5, L6, L7, (L7 is adjusted by expanding/compressing coils) Note: if more modulation is required remove D11 from circuit. Unit has 12W final...

ANTENNA MOUNTING-MOBILE

MY WAY

People are always asking me, "Where is the best place to mount my antenna"? 95% of the time - the antenna - turns out to be a \$10 Special from the local discount store, JUNK! Have to fight back the urge to tell them where it should really be mounted...

I very seldom do any antenna installation as it is always needed when 100+ in the shade; and 10 above (with wind chill factor of -40). Very easy to discourage people with a 100\$ minimum labor charge, and they have to leave their car. (Laugh, I do it all the time..!)

Whenever doing antenna work use ball mounts or magnetic mounts. Trunk deck mounts are utilized in some cases where the radio has a 'large bandwidth'. As a 102" whip won't do it.

When using a ball mount the first thing I do is 'throw away' all the exterior nuts/bolts/screws/washers, and utilize BRASS components for permanent installation. Silicon rubber is used to 'seal' the mount.

For Large/Middle size cars: mount on trunk lip, or ball mount on the trunk deck itself, using separate large plate underneath to prevent flexing of the metal (Old beer cans, in these new cars will flex readily!)

Small cars: Clamp bumper ball mount, trunk mount, in some cases will have to build a special bracket for ball mount so can attach to frame as no place to attach to bumper.

If a Slope back or Station Wagon try to talk into a magnetic mount, for top of the vehicle.

Pick-Up truck: ball mount on the pass. side of cab, magnetic mount, or mirror mount antenna. (To me nothing looks funnier than pick-up running down the road with dual mirror mounts)..

Vans: Magnetic, mirror mount, or ball mount (ball mount-up high on the side of van-not low or in the middle, will have SWR problems if not.)

If radio is stock Fo's, suggest 4' whip instead of 102" for the following reason: The large van body will pick up static electricity and if any electrical interference is around will attract. Use a lightning arrester...I ran into this problem \$\$ wiped out voltage regulator, and blew-up the battery! Didn't hurt the Radio?

Arcing will sound like a loud pocket watch out of time - Watch Out!

Whenever doing any antenna wiring exposed to the elements; I use Marine Coaxial cable also; it costs a little bit more - but worth it!

REMEMBER ABOVE IS THE WAY I DO IT...AS YOU CAN GATHER I DON'T DO MUCH ANTENNA WORK - DONE MY WAY OR FIND SOMEONE ELSE TO DO IT - BW.....

SPECIFIC TUNE-UP

OMNIVOX MDL. CB-1000: (LC7130-PLL, some have LC7131-PLL).

S Mtr-VR4, RF Mtr-VR3, Sq Rng-VR5

Tx: T7, L7, L10. Rx: T1, T2, T3, T4, T5.

(Schematic on this unit wasn't good/clear; but think that C207-electrolytic cap; is the AMC defeat if needed.)

COBRA 45XLR AM/FM/CB
Power and Frequency modification

Power Modification:

1. Remove driver and final, (save the final - 2SC1975.)
2. Remove right screw in the heat sink, (looking at chassis from back, component side up.)
3. Install the old final in driver's position, (or use a 2SC1306).
Reason for removing screw was to facilitate the mounting of driver to the heat sink, simply tilt up the driver.
4. Install 2SC1307 in final's position.
5. Retune for peak power on channel 1 if you are going to do the Fo mod.
If not, retune for best even power across present Fo coverage.

Frequency Modification: This unit has uPD858 PLL chip, and will give the Pin logic modifications (Logic 1 may be applied directly to pin, Logic 0 in this chip-have to cut etch to isolate pin, bridge with 5.1K back to logic feed, and apply Logic 0 to pin.)

Pin 19-1, 21-0

1 - 26.365	21 - 26.615
2 - 26.375	22 - 26.625
3 - 26.385	23 - 26.655
4 - 26.405	24 - 26.635
5 - 26.415	25 - 26.645
6 - 26.425	26 - 26.665
7 - 26.435	27 - 26.275
8 - 26.455	28 - 26.285
9 - 26.465	29 - 26.295
10 - 26.475	30 - 26.305
11 - 26.485	31 - 26.315
12 - 26.505	32 - 26.325
13 - 26.515	33 - 26.335
14 - 26.525	34 - 26.345
15 - 26.535	35 - 26.355
16 - 26.555	36 - 26.365
17 - 26.565	37 - 26.375
18 - 26.575	38 - 26.385
19 - 26.585	39 - 26.395
20 - 26.605	40 - 26.405

Pin 20-1, 19 and 21-0

1 - 26.765	21 - 26.215
2 - 26.775	22 - 26.225
3 - 26.785	23 - 26.255
4 - 26.805	24 - 26.235
5 - 26.815	25 - 26.245
6 - 26.825	26 - 26.265
7 - 26.835	27 - 26.675
8 - 26.855	28 - 26.685
9 - 26.865	29 - 26.695
10 - 26.075	30 - 26.705
11 - 26.085	31 - 26.715
12 - 26.105	32 - 26.725
13 - 26.115	33 - 26.735
14 - 26.125	34 - 26.745
15 - 26.135	35 - 26.755
16 - 26.155	36 - 26.765
17 - 26.165	37 - 26.775
18 - 26.175	38 - 26.785
19 - 26.185	39 - 26.795
20 - 26.205	40 - 26.805

PALOMAR SSB M1, 500B

TRANSMIT/RECEIVE BROADBANDING

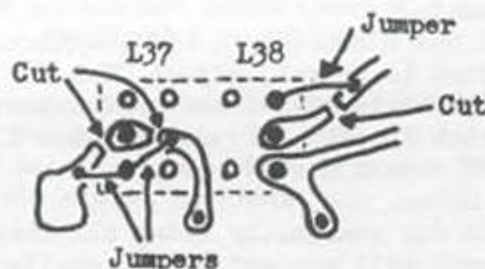
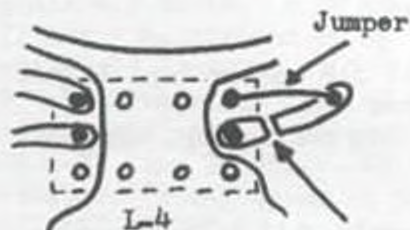

Do normal clarifier modification: DO NOT ADD CHOKE TO D37!

Remove CT3, D37, R143.....Follow the drawing below for building the new circuitry...

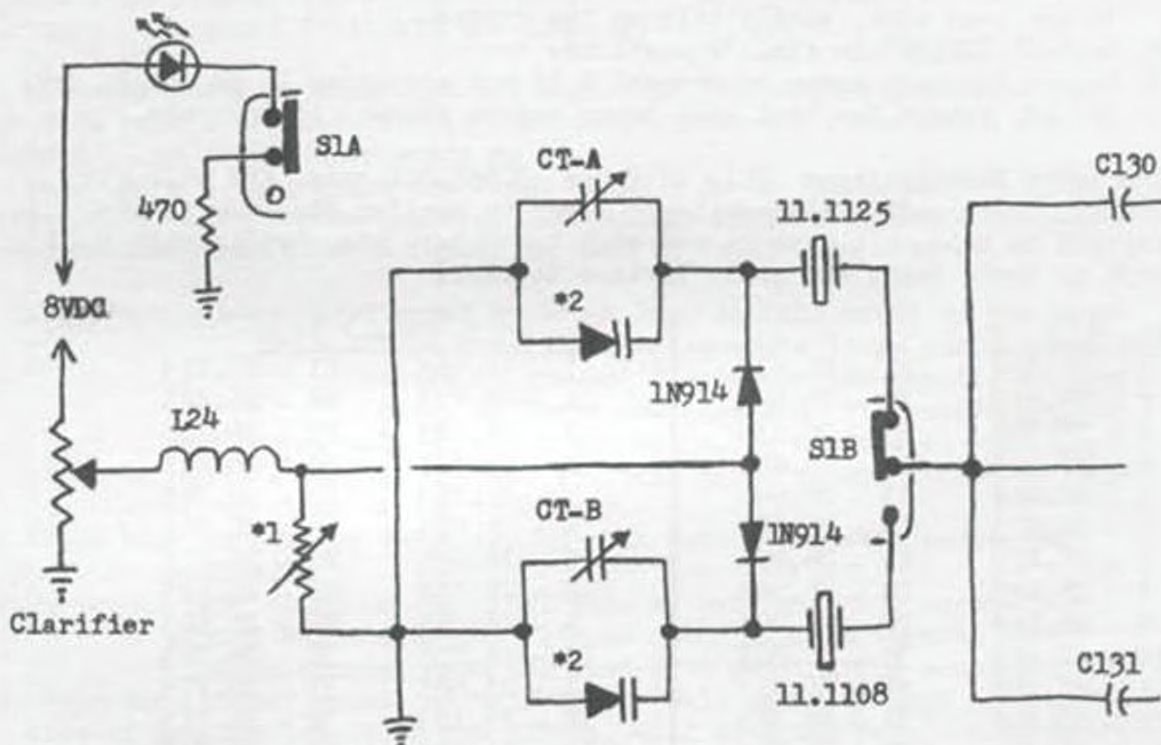

*1 - 10K, 10 turn adjustment \neq RT12C2Y103; mini-trimmer. Used for knob center adjustment. (Adjust to center position for pre-align).

*2 - Varactor Diode: MV2109 was used on prototype, final version utilized MV2209. If the center frequency is too low use MV2205. One note- the prototype did have a little more swing in the 5KC drop mode with the MV2109.

S1 - is two section switch with indicator light section for indicating 'normal' operation, or could rewire for indicating 5KHz drop by moving LED to other leg. (Switch is shown in normal configuration.)

Alignment:

1. Set the clarifier to mid-position.
2. Switch to normal, adjust CT-A for 11.1125 at S1B center leg. If you can't obtain adjust the mini-trimmer until you can.
3. Switch to 5KHz, adjust CT-B for 11.1108 at S1B center leg. If you can't obtain a center....

Now the fun starts..by using all three adjustments will have to go back and forth till you get it in..really isn't that hard, patience. Just don't move the clarifier knob while doing this alignment.....

VOLTAGE REGULATOR DESIGN - USING ZENER DIODE

The essential components in a zener voltage regulator are a limiting resistor and the zener.

The zener attempts to maintain a constant voltage (E_z) across itself by drawing the proper amount of current. Several important specifications are necessary in order to acquire the proper diode.

1. Choose the voltage of zener (E_z) you require: Values range from 2.4 to 200 Volts, and current ranges from $\frac{1}{2}$ to 50 Watts.
2. Figure the power rating: $P_z = E_z (I_{load}) (1.25)$. The 1.25 is a safety factor.
3. Figure maximum zener current ($I_z \text{ max.}$): $I_z \text{ max.} = P_z/E_z (.9)$. The 0.9 is the safety factor.
4. Series current limiting resistor is figured by: $R = ER/I_z \text{ max.}$
ER is the voltage drop across the resistor or Voltage input-zener voltage.
5. Power rating of resistor is: $PR = ER/I_z \text{ max.}$

(R = Resistance; I = Current; E = Voltage; P = Power)

Example of circuit requiring a voltage of 9V at 400ma (.4A) is given below:

SPECIFICATIONS

$E_{in} = 13 \text{ Volts}$
 $E_{out} = 9 \text{ Volts}$
 $I_{load \text{ max}} = 400\text{ma} (.4\text{A})$

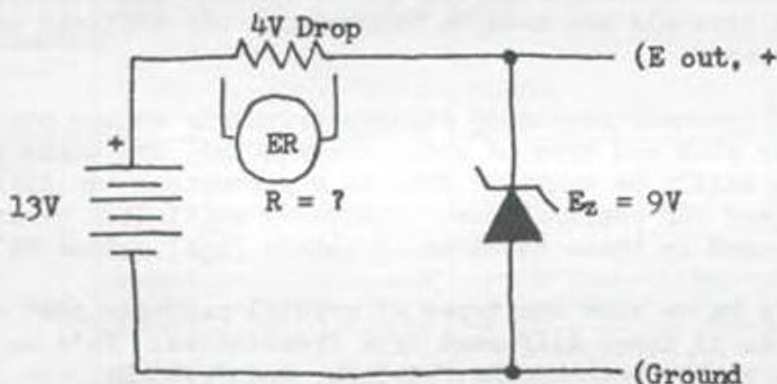

The following steps are necessary to determine the required circuit value.

1. Since 9V is required output voltage, a 9V zener is used.
2. Power rating = E_z times I_{load} times (1.25): 9V times .4Amp times 1.25 equals 4.5 Watts. A 5W zener is used as closest value above 4.5 watts.
3. $I_z \text{ max} = P_z$ divided by E_z times .9: 4.5W divided by 9V times 0.9 equals .45 Amps.
4. $R = ER$ divided by I_z : 4V divided by .45 equals 8.88 ohms. A 9.1 ohm resistor is used as closest standard value.
5. $PR = ER$ time $I_z \text{ max.}$: 4V times .45 Amps equals 1.8W. So use a 2W resistor. (Note: to be on the safe side always overrate your parts!)
REMEMBER MURPHY....

So, from the above calculations the specifications of circuit are:
5W, 9V Zener Diode and 2W, 9.1 ohm resistor.....

ALL ABOUT CRYSTALS

The Crystal Oscillator is the best choice when an accurate, stable frequency is needed. I'm sure everyone is familiar with the 10.240 Ref. Oscillator widely used in PLL circuits. Crystalline elements, such as quartz, are said to possess "piezoelectricity".

This means that if the material is deformed, it will generate a voltage. Also, if a voltage is applied to the crystal slab, it will deform, or oscillate, and therefore generates an AC voltage that has the that has the same frequency as the vibrations.

Equivalent circuit for a crystal is shown below:

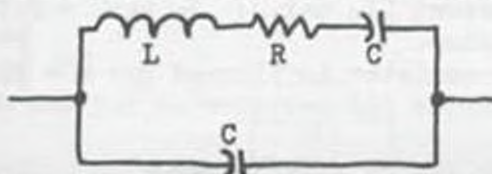

Notice that there is inductance, resistance and capacitance; both series and parallel..

The crystal can be either Series or Parallel resonant, depending on if the inductor resonates with the series or parallel capacitance. At series resonance: impedance is minimum. In parallel resonance, it is maximum.

Crystals can be ordered for the fundamental mode or the overtone mode. Fundamental: being the natural resonant frequency and generally under 30MHz, parallel resonant...below 500KC, series resonant type are used. Overtone crystals are made to resonate at odd multiple of the fundamental frequency.

The crystal resonant frequency depends primarily on the physical dimensions of the slab and type of cut. Above 20MHz, the slabs are so thin they can easily be broken. This is why overtone oscillators are used in VHF and UHF applications. Frequency multiplier circuits are extensively used in these services to obtain final output Fo's.

The drawings below show the types of crystal packages most common, and the picture is of three different type frequencies; Fo's on the crystals left to right are: 250KHz, 91.8KHz, and 7.925MHz.

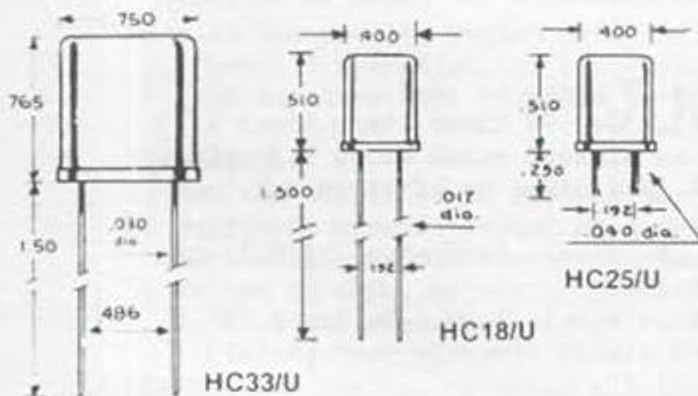

SECRET CB INDEX

VOLUMES 1 THRU 17

<u>CONVERSIONS:</u>	<u>VOL/PG</u>	<u>CONVERSIONS:</u>	<u>VOL/PG</u>	<u>CONVERSIONS:</u>	<u>VOL/PG</u>	<u>CONVERSIONS:</u>	<u>VOL/PG</u>
Conversion tips for all SSB radios.....9/7		<u>COLT</u> SX33.....3/4-7		<u>HYGAIN</u> I-A.....1/22		<u>PACE (cont.)</u> 8025.....15/44	
"A" Channel Mod. for all SSB.....9/16-17		290.....3/4-7		PLL.....1/32		8092.....6/35-36	
Cybernet Freq. Mod.....8/18		390.....3/4-7		II.....8/20		8093.....15/48	
Uniden 8719PLL Mod.....8/15		480.....3/8-15,5/39		<u>ITT</u>		8155.....15/43	
M88719 Mod.....10/25-26		485.....3/8-15		CB-4000M.....13/61		<u>PALOMAR</u>	
M88719 w/11.1125 Mod.11/15, UPDATE.14/11-12		800.....3/4-7		CB-4400M.....4/17-18		500.....4/19-20,5/32-36,8/21	
PLLO1A Mod.....9/15-17		1000.....3/8-15		<u>J. C. PENNEY</u>	15/45	
PL102A Mod..4/54-55,3/13-15		<u>COURIER</u>		6246.....13/61		<u>PANASONIC</u>	
02A Truth Table.....15/12-13		Centurion PLL....1/31,61-62		6248.....8/24		RJ3600.....10/57	
23 Ch. PLL02A AM Conv.	5/57		<u>JOHNSON</u>		RJ3700.....13/16-17	
26.645 to 27.275.....12/32		Centurion 400.....10/53		242-4730.....10/49-51		<u>PEARCE-SIMPSON</u>	
Tech tips on the 858		Galaxy.....5/53-54,7/18-22		4125/4174.....13/61		Cheetah PLL.....1/31-32	
Chassis.....10/55		Gladiator PLL....1/31,61-62		4140.....15/31		Simba PLL.....1/31-32	
Uniden 858 update.....9/8-11	5/55-57		4740 (NDC40013).....11/12		<u>PRESIDENT</u>	
How to get on 28 & 29 Mhz w/uPD858 PLL.....11/4-7		Spartan.....1/61-62		<u>KENWOOD</u>		Adams.....2/16,13/18-20	
uPD858 AM Conv.....11/35	5/30,53,55,57		TS-1208.....12/22		AR144.....11/17-18	
Receiver Widebanding for 858 Chassis.....13/34		<u>CPI</u>		TS-130.....12/23		Grant.....1/22-23,5/9	
New Thumbwheel Conversion for 858 chassis...13/35-37		300.....8/21		TS-820S.....14/7-8,15/32-34	2/17,23-26	
How to increase ANL efficiency 70%.....11/8		400.....8/21		<u>KRACO</u>		Grant (NEW),5/24-27,13/21-22	
Ham Radio Crystal Selector.....12/24		2000.....3/25		KCB2330A.....9/15		Home Ch. Conv....14/13-17	
<u>ROMAN</u>		2000 Low.....9/23		KCB4806.....15/59		Honest Abe.....1/60	
CR910.....11/41,13/58		2500.....5/37-38		<u>LAFAYETTE</u>		John Q.....1/60	
CB920.....14/43		<u>CRAIG</u>		SSB75.....14/9		Madison w/11.3258.....10/30	
CB930.....3/21		L131 & L231.....9/12-14		<u>LAKE</u>		McKinley.....4/12-13	
CB950.....5/39		L132 & L232.....9/12		400.....16/52		McKinley w/11.1125.....10/29	
<u>BROWNING</u>		L232 & L132 w/uPD2824C		<u>MECTRON</u>		Teddy R.....1/60	
Mark III.....6/28		Chip.....10/47,11/10		ME400.....17/34		Washington.....1/22-23,5/9	
Mark IV.....6/29-30		L321.....14/12		ME502.....14/41		Washington w/11.1125	
Mark IVA.....14/5-6		<u>DAK</u>		<u>MIDLAND</u>		(NEW).....10/28-29	
Mark IV, IVA.....7/8-14		IX.....5/21-23		CAP 858.....5/30		Zachary T.....1/60	
Sabre.....1/27		IX Mod. Update.....9/18-19		13-857.....11/36		<u>RAIDER</u>	
<u>CHANNEL MASTER</u>		X.....4/39-46		13-862.....14/48-49		4060.....15/46	
CM6830.....14/41		<u>DELCO</u>		13-882C (02A).....13/62,15/35		<u>RCA</u>	
<u>COBRA</u>		Delco Factory AM/FM/CB		13-883B (uPD858).....12/4		14T302.....5/11,39	
CM899.....14/45-46		Combo Unit.....11/38-40		76-858.....16/21-24		14T302 (PLL 02AG).....4/36	
12XLR.....4/47		DM83.....12/26		77-861.....12/26		<u>REALISTIC</u>	
50XLR/55XLR.....16/53		90BFMC1.....12/26		78-574.....14/10		TRC-57.....12/28	
132B.....1/53		90BFPC1.....12/26		79-892.....15/36-38		TRC-431.....7/23-24	
132XLR.....4/47		91YFMC1.....12/26		79-893.....2/20		TRC-448 (REC86345).....11/19	
135B.....1/53		<u>DEMCO</u>		79-900.....5/47	16/25-30	
135XLR.....4/38		Star II.....5/60		6001.....11/16,16/60-62		TRC-450.....10/31	
135XLR Update.....10/43-46		Super Satellite.....5/60		7001.....8/21,11/16,16/60-62		TRC-451.....12/10-13	
138XLR.....1/20-23		<u>FANON</u>		<u>MORSE</u>		TRC-455 (SMS104).....12/30	
139XLR.....1/20-23		Fanfare 350.....5/57		3005.....2/27		TRC-457.....10/36	
140GTL.....3/19-20,4/50		<u>FIELDMASTER</u>		<u>MOTOROLA</u>		TRC-459.....10/32-35	
.....10/28-29		Micro Mini 40.....11/37		CB555 (TC9105P).....12/7		TRC-480.....10/37-38	
142GTL.....4/50,10/28-29		TR-40.....15/63		T4025A.....10/46		TRC-490.....12/14-15	
146GTL.....11/17-18,15/18-19		<u>GENERAL ELECTRIC</u>		<u>NESCO</u>		<u>RAY JEFFERSON</u>	
148GTL.....8/16		Superbase 3-5875/A.....10/48		1249.....6/38		CBB45 (02A).....12/27	
148GTL-B.....17/41-43		3-5801A.....16/33,17/39		<u>PACE</u>		<u>ROBYN</u>	
148GTL-DX.....15/20-24		3-5813A/3-5869A.....14/41		166.....15/42		GT-440D.....1/23	
.....16/50-51,17/47,54-58		<u>GEMTRONICS</u>		1000MC/1000BC.....15/39-41		SB-505.....5/41-42	
2000 (C.A.P.).....6/23		GTX77.....5/39		8010A.....15/43,17/60-61		SB-520D.....2/21-22	
2000GTL.....5/20,7/15-17		GTX-2325.....15/29		8015A.....15/43,17/60-61		SB-540D.....5/19,36,7/25-28	
.....15/25-28		<u>HALLICRAFTERS</u>				WV-23.....1/24-25	
		HCM271.....5/50-51,6/39				WV-110 (SMS104).....12/31	

<u>CONVERSIONS:</u>	<u>VOL/PG</u>	<u>CONVERSIONS:</u>	<u>VOL/PG</u>	<u>SLIDE MODIFICATIONS:</u>	<u>VOL/PG</u>	<u>SLIDE MODIFICATIONS:</u>	<u>VOL/PG</u>
<u>ROYCE</u>		<u>TEABERRY (cont.)</u>		<u>BOMAN</u>		<u>LAFAYETTE</u>	
1-601.....	1/26	Ranger T.....	4/1-2,6/24-25	950.....	4/49	55875.....	14/9
1-612.....	5/45-46	Stalker I..	1/57,4/5-6,10-11	<u>BROWNING</u>		<u>MIDLAND</u>	
1-632.....	11/21	Stalker IX..	4/7-9,15/55-57	Baron.....	15/15-17	13-883B.....	12/4
1-632 Update.....	13/23	Stalker IX (FM Export)			13-892.....	4/48,11/13
1-639.....	15/48	15/50-54	<u>COBRA</u>		13-893.....	4/51
1-641.....	11/20	Stalker XV.....	4/7-9,10/39	29GTL.....	13/57	13-898.....	1/36
1-642.....	13/24	Stalker XX.....	10/40	132-A.....	1/28	13-898B.....	1/35
1-655.....	15/47	T Bear.....	4/14-15	132XLR.....	10/45-46,15/15-17	78-574.....	14/10
<u>SANKYO</u>		T Dispatch.....	4/14-15	135-A.....	1/28	78-999.....	12/5
SCS-555.....	11/40	Titan T.....	4/14-15	135-B.....	1/29	79-891.....	12/6
<u>SBE</u>		<u>TENNA POWER</u>		135XLR.....	4/38,8/38,10/45-46	79-892.....	11/14
Console II.....	15/49	10901.....	15/63	15/15-17	79-900.....	5/47
Console IV.....	2/28-35	<u>TRAM</u>		138.....	1/28	6001.....	11/16
Console V.....	2/28-37	D12.....	10/56	138XLR.....	1/23	7001.....	8/21,11/16
Console VI.....	8/14	D42.....	4/47,5/40	139.....	1/30	<u>MOTOROLA</u>	
Cortez 21CB.....	14/56-57	D60.....	1/53	139XLR.....	1/23	CB-555.....	12/7
Formula D.....	1/49	D64.....	13/31	140GTL.....	4/50,6/64,10/28	<u>N. D. I.</u>	
LCBS-4.....	7/29-33	D80.....	10/30	142GTL.....	4/50,6/64,8/35-37	PC-201 (NDC40013PLL)...	12/8
LCMS-4.....	7/34-37	D201.....	1/56,3/22-23,4/48	10/28		
Sidebander II.....	2/28-35	D201A Update.....	10/54,17/53	146GTL.....	10/41,11/17	<u>PACE</u>	
Sidebander V.....	2/36-37	D300.....	8/11-13	148GTL.....	8/16	1000.....	1/37-38
Sidebander VI.....	8/14	XLR (23-SSB).....	17/53	2000GTL.....	12/20,13/40	DX1023B.....	1/39
Touch Com.....	1/50-51	<u>TRISTAR</u>		<u>COLT</u>		8092.....	6/37
<u>SEARS</u>		747.....	15/58,16/68	480.....	3/11	8193 (CC13001).....	12/9
D63911 w/uPD861C.....	12/26	747 Update.....	17/35	485.....	3/11,4/49	<u>PALOMAR</u>	
562-38220700.....	10/56	<u>TRS CHALLENGER</u>		1000.....	3/11	500.....	4/19,5/32,35
663-3810 w/2824.....	11/22	850/1400.....	4/21-27,32-35	<u>COURIER</u>		<u>PANASONIC</u>	
934-3677150.....	12/16-17	<u>VECTOR</u>		Centurion.....	1/61,5/55	RJ-3700.....	13/16-17
934-36772600.....	12/16-17	770.....	4/56-57	Centurion 400.....	10/53	<u>PEARCE-SIMPSON</u>	
934-38260700.....	6/26-27	790.....	4/58-59	Galaxy.....	5/53,7/19	Bengal.....	1/40
934-38260700 Update.....	11/23	<u>WARDS</u>		Gladiator PLL.....	1/61,5/55	Cheetah.....	1/40
934-38270700.....	5/28-29	719A w/uPD 2824.....	11/10	Spartan.....	1/61,5/55	Simba.....	1/40
934-38270700 Update.....	9/20-22	<u>YAESU</u>		<u>CPI</u>		<u>PRESIDENT</u>	
<u>SHARP</u>		101.....	5/58	2500.....	5/37	AR144.....	10/41
CB-5470 HD42851B3.....	11/24	FT-7B.....	7/38-41	<u>CRAIG</u>		Adams.....	1/16
<u>SILTRONIX</u>		FT-707.....	10/20-24	L-131.....	9/12-14	Adams 858.....	13/18-20
1011C.....	1/46	FT-901.....	6/3-12	L-132 uPD2824C.....	9/12,10/47	Dwight D.....	15/62
1011D.....	1/46	For most 23 channel radios, see crystal cross reference guide.....	1/6-18,2/5-13	L-231.....	9/12-14,12/3	Grant.....	1/59,2/23
<u>SOMMERKAMP</u>		L-232.....	9/12,10/47,11/10	Grant (NEW).....	5/24,8/34
TS-788DX.....	13/25-30	<u>SONAR</u>		L-321.....	14/12	Grant MB8719.....	13/21-22
<u>SONAR</u>		PS-2340.....	5/31	<u>DAK</u>		Madison (NEW).....	10/30
<u>SPARKOMATIC</u>		<u>STONER</u>		X.....	4/45	McKinley.....	4/12,6/64
CB4020S.....	14/41	Pro-40.....	4/52-53	<u>FANON</u>		McKinley (NEW).....	10/29
<u>STANDARD HORIZON</u>		<u>SUPERSCOPE AIRCOMMAND</u>		Fanfare 350F.....	5/55	Washington.....	1/59
29-A.....	5/59,13/63	CB140.....	8/19	<u>GENERAL ELECTRIC</u>		Washington (NEW).....	6/64
<u>STONER</u>		CB140 (861 Update).....	9/24	3-5875A.....	10/48	8/33-34,10/28
Pro-40.....	4/52-53	<u>SWAN SIGNET</u>		<u>GEMTRONICS</u>		<u>RCA</u>	
<u>SUPERSCOPE AIRCOMMAND</u>		270.....	5/58	GTX-77.....	4/49	14T302.....	4/49
CB140.....	8/19	<u>TEABERRY</u>		<u>HYGAIN</u>		<u>REALISTIC</u>	
CB140 (861 Update).....	9/24	52 Ch. Capability.....	1/43	V.....	11/11	TRC-47.....	1/41
<u>SWAN SIGNET</u>		CAP Mod.....	5/30	623.....	1/33	TRC-48.....	1/42
270.....	5/58	Model T.....	4/3-4	674-A.....	4/60	TRC-57.....	12/28
<u>TEABERRY</u>		Racer T.....	1/58	J. C. PENNEY		TRC-448.....	11/19,17/54
52 Ch. Capability.....	1/43	<u>TENNA POWER</u>		Pinto SSB.....	1/44	TRC-450.....	10/31
CAP Mod.....	5/30	10901.....	15/63	6248.....	13/14-15	TRC-451.....	12/10
Model T.....	4/3-4	<u>TRAM</u>		981-6247.....	13/13	TRC-457.....	10/36
Racer T.....	1/58	D12.....	10/56	<u>JOHNSON</u>		TRC-458.....	8/39-40
		D42.....	4/47,5/40	242-4730.....	10/50	TRC-459.....	10/34
		D60.....	1/53	352.....	1/34	TRC-480.....	10/38
		D64.....	13/31	4740.....	11/12	TRC-490.....	12/14-15
		D80.....	10/30				
		D201.....	1/56,3/22-23,4/48				
		D201A Update.....	10/54,17/53				
		D300.....	8/11-13				
		XLR (23-SSB).....	17/53				
		<u>TRISTAR</u>					
		747.....	15/58,16/68				
		747 Update.....	17/35				
		<u>TRS CHALLENGER</u>					
		850/1400.....	4/21-27,32-35				
		<u>VECTOR</u>					
		770.....	4/56-57				
		790.....	4/58-59				
		<u>WARDS</u>					
		719A w/uPD 2824.....	11/10				
		<u>YAESU</u>					
		101.....	5/58				
		FT-7B.....	7/38-41				
		FT-707.....	10/20-24				
		FT-901.....	6/3-12				
		For most 23 channel radios, see crystal cross reference guide.....	1/6-18,2/5-13				
					

SLIDE MODIFICATIONS: VOL/PG

BOBYN
SB-505.....5/41
SB-540D.....5/19
7240D.....13/63

ROYCE
1-632.....5/14,11/21,13/23
1-641.....4/51,11/20
1-642.....13/24

SANBYO
SCS-555.....11/40

SBE
Console II.....1/48
Console IV.....2/34,38-40
Console V.....2/34,38-40
LCBS-4.....7/30
LCMS-4.....7/34
Sidebander II.....1/47
Sidebander IV.....2/34,38-40
Sidebander V.....2/34,38-40

SEARS
23 Ch. SSB.....1/44
Roadtalker SM5104.....12/18
663-3810.....11/22
934-3677150.....12/17
934-36772600.....12/17
934-38260700.....10/52
934-38270700.....5/28,9/20
934-38310700.....5/19,9/22

SHARP
CB5470.....11/24

SILTRONIX
SSB.....1/45

STONER
Pro-40.....4/52,53

TEABERRY
Stalker IX.....4/7-8
Stalker XV.....4/7-8,10/39
Stalker XX.....10/40
Stalker 101/202.....4/10

TRAM
D60.....1/52
D62.....10/45-46,15/15-17
D64.....13/31
D300.....12/19

TRS CHALLENGER
850/1400.....4/33,16/55

TRUETONE
CY34837A-87.....11/14

WARDS
GEN-719A.....11/10

SPECIFIC RADIO TUNEUPS:

AIR COMMAND
VOL/PG
CB640.....5/38

ALARON
B-4075.....9/30
B-4900.....9/30
B-5050A.....9/30
B-5200.....3/41

AMERICAN MOTORS
3221847/48/49/50.....12/34

AUDIOVOX
MCB750.....3/41
MCB5000.....11/42
MCU6000.....6/18,15/60

AUTOMATIC
CBH2265.....3/41

BETA
23 Deluxe.....16/32

BOMAN
CB555.....3/44
CB750.....2/43
CB755.....14/44
CBH900.....3/44
CB910.....1/21,3/44
CB920.....1/21,14/43
CB930.....1/21,3/44
CB950.....3/43
CBH990.....5/43
CBR9600.....2/42,3/41
CBR9940.....3/44
CBR9950.....10/58

BRISTOL
BCB-2271.....16/41

BROWNING
SABRE.....14/42

CHANNEL MASTER
CB6830.....16/55
CB6834.....14/44
CB6835.....6/18

CHRYSLER
4048076/8077.....6/18

CLARION
DMA066.....3/45
JC202E.....3/45
RCJ003.....3/45
TC203E.....6/18

COBRA
CAM89.....14/45
19.....7/51
19GTL.....12/34
21GTL.....3/41,58
21XLR.....1/20
21XLR Update.....10/58
25GTL.....3/41,58
25LTD.....17/35
29GTL.....3/45,14/42
29LTD.....13/59
29XLR.....1/20
32XLR.....3/58
45XLR.....12/34
46XLR.....3/43
47XLR.....3/45

SPECIFIC RADIO TUNEUPS:

COBRA (cont.)
VOL/PG
50XLR.....3/43
55XLR.....3/43
66GTL.....10/58
77X.....9/30
78X.....4/49,6/19,8/44
85.....15/61
86XLR.....3/45
87GTL.....6/19
89GTL.....6/18
132XLR.....3/45,16/39
135XLR.....3/45,4/38,16/39
138XLR.....1/20
139.....1/20
139XLR.....1/20
140GTL.....3/20,58,4/50
142GTL.....4/50
146GTL.....10/41
148GTL.....6/19
148GTL-B.....16/55
148GTL-DX.....16/43-49
150GTL.....17/42
1000GTL.....6/18,14/42

COLT
222.....6/20
290.....3/4
350.....14/46
390.....3/4
480.....3/8,58
485.....3/8,6/19
510.....17/42,45
800.....3/4
800 Update.....10/58
1000.....3/8,58
1200.....9/30-31,16/55

COMMANDO
2340.....1/21

CONVOY
CON-400.....3/58

COYOTE
23.....16/32

CPI
CP400.....10/59

COURIER
Blazer 40D.....3/58
Centurion 40D.....10/53,13/10
Classic PLL40.....3/43
Classic PLL40 Update.....10/59
Galaxy.....5/53
Nightrider 40D.....3/46
Rangler 40D.....3/58
Redball.....1/21
Renegade 40.....3/46
Rouge 40.....3/43

CRAIG
L101.....6/20,11/42
L102.....6/20
L131.....10/59
L132.....9/12,10/47
L231 (AM, SSB).....10/60
L232.....10/47,11/10
4102.....16/32

DAK
Mark II.....10/60
Mark V.....12/34
Mark X.....4/45

SPECIFIC RADIO TUNEUPS:

DELCO
VOL/PG
70BFMC3.....2/43
80BCH2.....6/20
90BCB1.....10/60
90BFMC1.....12/26
90BFPC1.....12/26
90BFTC1 (FM, AM, CB).....10/60
91YFMC1.....12/26

FANON
10-40.....6/20
Fanfare 125F.....3/43
Fanfare 182F.....3/41
Fanfare 184DF.....3/47
Fanfare 185PLL.....3/46
Fanfare 190DF.....3/47,7/51
Fanfare 350F.....3/47,13/12

FORMAC
40.....10/60

GENERAL ELECTRIC
3-5800A.....3/50
3-5804B.....6/21
3-5804F.....10/61
3-5804G.....12/35
3-5805A.....9/31,10/61
3-5811B.....9/31,10/61
3-5812A.....10/61
3-5814B.....6/21
3-5817A.....7/51
3-5818A.....2/42
3-5819A.....11/42
3-5821A.....9/31
3-5821B.....3/54
3-5825A.....9/31-32
3-5830.....3/42
3-5869A.....2/42
3-5871A.....13/60
3-5871B.....3/46
3-5875A.....9/32,10/48
3-5900A.....12/35

GEMTRONIX
GTX-23.....15/61
GT44.....2/42
GT55.....3/48
GTX66.....6/21
GTX77.....6/21
GTX3323.....17/59
GTX4040.....3/48
GTX5000.....3/42,13/60

GENERAL MOTORS
CBD-20U (PLLO3A).....12/36
CBD-203.....3/48
4120.....3/46
4145.....9/32
4175.....3/46

GREAT
K605/GTB18.....16/32

HYGAIN
VIII.....3/59
674A.....4/60
V674B.....1/21
2701.....2/42
2702.....3/48
2703.....3/48
2716.....12/36

SPECIFIC RADIO TUNEUPS:

	VOL/PG
ITT	
4000M.....	13/61
4400M.....	4/17
J. C. PENNEY	
6246.....	13/61
981-6203.....	15/30
981-6204.....	9/32
981-6225.....	14/47
981-6248.....	13/14-15
981-7461.....	9/32
981-8360.....	10/61
JIL	
615CB.....	11/42
JOHNSON	
123A.....	1/21
4125/4174.....	13/61
Messenger 40.....	12/36
Messenger 50.....	7/51
Messenger 80.....	7/51
Messenger 4120.....	3/47
Messenger 4135.....	3/48
Messenger 4140/4145.....	3/54
Messenger 4170/4175.....	3/47
.....Update.....	11/43
Messenger 4250.....	3/48
Viking 200.....	12/36
Viking 260/270.....	3/49
Viking 4330/4360.....	11/43
Viking 4740.....	11/12
K-40	
K-40.....	15/60
KRACO	
KB4045.....	14/47
KCB-2340.....	2/42
KCB-4000.....	11/43
KCB-4003.....	3/42
KCB-4005.....	9/38,11/43
KCB-4020.....	3/49
KCB-4030.....	8/44
KCB-4088.....	3/50
KRIS	
XL25.....	2/43
LAFAYETTE	
Comstat.....	11/45
Dyna-Com 40.....	11/44
CHB740.....	15/60,16/55
HB640.....	2/43
LM-100 (PLL02A).....	12/36
LM-300.....	12/37
SSB75.....	14/9
SSB140.....	11/44
Teletat 1240.....	5/14
LAKE	
410.....	12/37
450.....	12/37
600.....	12/37
MEDALION	
63-240.....	3/50
MIDLAND	
100M.....	10/67
102M.....	14/42,17/59
150M.....	7/52
13-858.....	14/42

SPECIFIC RADIO TUNEUPS:

	VOL/PG
MIDLAND (cont.)	
13-862.....	14/48
13-867.....	13/62
13-879.....	14/50
13-881.....	15/61
13-882C.....	13/62
13-892.....	4/48
13-893.....	4/51
63-445.....	11/45
76-858.....	3/49
76-860.....	14/51
76-863.....	3/50,9/33
77-101B.....	8/44
77-101C.....	12/38
77-821.....	3/42
77-824.....	8/44
77-824B.....	12/38
77-824C.....	12/39
77-838.....	9/33
77-849.....	3/50
77-853.....	16/55
77-856.....	11/45
77-861.....	3/50
77-861B.....	11/45
77-865.....	9/33
77-899.....	9/33
77-963.....	3/42
78-574.....	9/38,12/39,14/10
78-999 (02A).....	12/5
79-891 (02A).....	12/5
79-892.....	3/49
79-893.....	2/20
79-900.....	9/33-34
1001.....	17/65
3001.....	12/37
4001 (77-004).....	7/52
5001.....	12/37
6001.....	11/16
7001.....	11/16
7001 (79-007).....	11/45-46
MOPAR	
4094173.....	3/51
4094176.....	3/51
4094177.....	3/49
4094178.....	3/60
MORSE	
2001.....	14/42
MOTOROLA	
CB555.....	12/7
CF925AX.....	11/46
CC975AX.....	16/40
Mocat 40.....	11/46
T4000A/05A/10A/20A.....	3/50
N. D. I.	
PC-102.....	11/46
PC-200.....	7/52
PC-201.....	12/8
PAGE	
CB144.....	14/42
CB166.....	15/60
8003.....	11/47
8008.....	2/43
8016.....	11/47
8046.....	9/33
8113.....	12/39
8117.....	11/47
8155.....	9/34,12/40
8193.....	7/52

SPECIFIC RADIO TUNEUPS:

	VOL/PG
PACIFIC	
SSB800.....	16/55
PALOMAR	
49.....	3/60
500.....	4/19,5/32
2400.....	17/42,44
4100.....	3/54
PANASONIC	
CR-8474EU (AM,FM,CB).....	9/34
RJ-3200.....	14/42
RJ-3250.....	11/47
RJ-3600.....	11/48
RJ-3660.....	14/52
RJ-3700.....	13/17
PEARCE-SIMPSON	
Cougar 23.....	14/53
Leopard B.....	3/49
Puma 23B.....	13/62
Supertiger 40A.....	3/60
Tiger 40A.....	9/34
PIONEER	
GT-100G (AM,FM,CB).....	10/62
PRESIDENT	
AR-7.....	12/40
AR-44.....	10/63
AR-144.....	10/41
AR-711.....	12/34
AX-7.....	12/45
AX-11.....	12/45
AX-14.....	12/45
AX-44.....	12/45
AX-52 & AX-55.....	12/45
AX-144.....	12/45
AX-711.....	12/40,45
Adams.....	2/16
Andrew J.....	9/34
Dwight D.....	10/62,14/54
Grant.....	1/22
Grant (NEW).....	5/24
James K.....	7/52
James K (NEW).....	12/40
McKinley.....	4/12
Old Hickory.....	9/34
Washington.....	1/22
Zachery T.....	14/54
RAY JEFFERSON	
CB-845.....	11/48
RCA	
14T270.....	9/36
14T300.....	2/43
14T302.....	3/53
14T303.....	11/48
REALISTIC	
TRC-45A.....	4/37
TRC-47.....	1/21
TRC-57.....	1/21,12/28
TRC-99A.....	4/37
TRC-100.....	4/37
TRC-180.....	4/37
TRC-200.....	4/37
TRC-200 Update.....	10/63
TRC-204.....	10/63
TRC-205.....	12/40
TRC-206.....	14/55
TRC-209.....	10/63

SPECIFIC RADIO TUNEUPS:

	VOL/PG
REALISTIC (cont.)	
TRC-209 (GRE7189PLB-VC).....	12/49
TRC-210.....	16/32
TRC-211.....	17/34
TRC-212.....	17/34
TRC-410.....	12/29
TRC-411.....	15/60
TRC-420.....	12/41
TRC-421.....	8/44,12/41
TRC-421A.....	9/35
TRC-422.....	8/45
TRC-422A.....	10/64,67
TRC-424.....	3/57,9/35
TRC-425.....	7/53,10/67
TRC-426.....	10/64
TRC-427.....	8/45
TRC-428.....	11/48
TRC-431.....	4/37
TRC-432.....	11/48
TRC-440.....	8/45,9/35
TRC-441.....	10/67,11/49
TRC-448.....	3/51,10/64,11/19
TRC-449.....	3/51,9/35-36
TRC-451.....	12/10
TRC-452.....	1/21,3/52
TRC-454.....	8/45
TRC-455.....	3/60
TRC-456.....	10/67
TRC-457.....	9/35-36,10/36
TRC-458.....	9/35
TRC-459.....	10/34
TRC-461.....	3/51
TRC-462.....	9/36
TRC-466.....	3/51
TRC-468.....	3/57
TRC-470.....	9/39,12/41,16/40
TRC-471.....	8/45
TRC-480.....	7/53,10/37
TRC-490.....	11/49,12/15
REGENCY	
CR240.....	16/32
ROADRUNNER	
CB5000A.....	16/41
ROBERTS	
40 Ch.....	14/42
ROBYN	
007-140.....	3/52
AM500D.....	3/52
DG130D.....	3/56
GT-410D.....	3/57
LB120.....	3/52
SB-505.....	5/42
SB-520D.....	2/22
SX-401.....	3/57
SX-402D.....	3/57
T240D.....	3/56,13/60,63
WV110.....	3/56
WV110 Update.....	11/50
ROYCE	
1-580.....	16/32
582 (PLL3001).....	12/42
604.....	3/56-57
607.....	12/42
611.....	14/55
1-617.....	3/52
1-619.....	3/56
1-621.....	3/57
1-625.....	3/56

MISCELLANEOUS LISTED BY VOLUME

SPECIFIC RADIO TUNEUPS:

	VOL/PG
ROYCE (cont.)	
1-632.....	11/21
1-639.....	12/41
1-641.....	3/60, 4/51, 11/20
1-642.....	13/24
1-650.....	14/42
1-651.....	7/55
1-655.....	11/50
1-660.....	2/42
1-673.....	3/52
1-675.....	3/53
1-680.....	3/52

SBE

Console V.....	15/61
21-CB Cortex.....	14/56
26CB1A.....	3/61
42CB Cortex 40.....	3/61
43CB.....	3/53
44CB.....	9/36
45CB Trinidad III.....	3/61
47CB.....	3/53
49CB Tahoe 40.....	3/53
LCB-8 (uPD2826C).....	12/43
LCBS-4.....	7/32
LCM-5 Land Command.....	9/36
LCM-8.....	9/36
LCM-8 (PLLO3A).....	12/42
LCMS-4.....	7/35
LCMS-8 (uPD2816C).....	12/43

SEARS

CM-6000LA.....	3/59
CM-6000LC.....	3/59
Roadtalker 40.....	2/43
370-38050700.....	3/54
562-38200700.....	3/55
663-38020800.....	7/53
663-38070700.....	3/61
663-3810.....	11/22
663-381050.....	11/21
934-3677150.....	12/16
934-36772600.....	12/16
934-38060700.....	17/65
934-38061700.....	11/50
934-38062700.....	10/65
934-38080700.....	9/37
934-38081700.....	9/38
934-38120700.....	3/61
934-38260700.....	7/53
934-38270700.....	7/54
934-38310700.....	7/54-55

SHAKESPEARE

GHS240.....	3/53
-------------	------

SHARP

CB-23.....	13/63
CB-800.....	2/42
CB-2170.....	12/43
CB-4370.....	12/43
CB-4470.....	12/44
CB-4670.....	7/55
CB-5470.....	11/24

SONAR

FS-2340.....	5/31
--------------	------

SPARKOMATIC

SH-42/CBM.....	3/54
----------------	------

STANDARD

29.....	1/22
29A (uPD857).....	13/63

SPECIFIC RADIO TUNEUPS:

	VOL/PG
SUPERSCOPE	
Aircommand CH1040.....	14/57
SURVEYOR	
620.....	3/55
2610.....	3/54

TEABERRY

Big T.....	15/61
Model T.....	3/55
Racer T.....	3/55
Titan T.....	15/61
Stalker II.....	1/21
Stalker III.....	7/55
Stalker IV.....	12/44
Stalker V.....	7/55
Stalker VIII.....	10/65
Stalker IX.....	10/65
Stalker XII.....	7/56
Stalker XV.....	10/39
Stalker XX.....	10/40
T Charlie.....	10/65
T Command.....	3/55
T Dispatch.....	3/55

TENNA

10901.....	10/58
10902.....	10/65
11302 (AM,FM,CB).....	9/37

TRS

Challenger 432.....	4/23
Challenger 460.....	14/59
Challenger 600.....	9/37
Challenger 850.....	4/32, 7/55
Challenger 1200.....	12/44

TRAM

D12.....	3/54
D64.....	13/31
XL-5.....	16/32

TRUETONE

CYJ4832-A-87.....	2/43
CYJ4837-A-87.....	3/59
CYJ4862-A-87.....	9/39
MCC4434A-57.....	14/60
MCC4726A-67.....	15/61

UTAC

TRX-400.....	3/59
TRX-500.....	5/56

VECTOR

X.....	2/43
770.....	9/37
790.....	9/37

WARDS

GEN-680A.....	14/61
GEN-696A.....	14/61
GEN-719A.....	11/10
GEN-775A.....	3/61

XTAL

XSSR10.....	1/22
-------------	------

VOLUME 1

	PAGE #
GOLDEN EAGLE MARK IV PING MODIFICATION.....	20
CRYSTAL CROSS REFERENCE GUIDE.....	5-10
LETTER CHART FOR CRYSTAL FREQ. CORRELATION.....	11-18
GENERAL INFORMATION.....	63-67
LINEARS.....	68-70

VOLUME 2

	PAGE #
NEW CRYSTAL CROSS REFERENCE GUIDE.....	5-9
LETTER CHART FOR CRYSTAL FREQ. CORRELATION.....	10-13
PRESIDENT GRANT RF GAIN & ADJACENT CH. REJ. MOD.....	18-19
ROBYN 510D/520D NOISE BLANKER ALIGNMENT.....	25-26
COBRA 139XLR SERVICE BULLETIN ON CRYSTAL DRIFT PROBLEM & PCB CRACKING.....	45-50
SERVICE BULLETIN ON SIDEBANDER II & CONSOLE II FOR IMPROVING CROSS MODULATION REJECTION.....	51
SERVICE BULLETIN-COBRA 29 ON MODULATION IMPROVEMENT, ALSO NOISE BLANKER.....	52
ANTENNA REPORTS.....	53-55
BETA-COM INPO (UPGRADING 23 CHANNEL RADIOS).....	57-67

VOLUME 3

	PAGE #
PRESIDENT MADISON FREQ. COUNTER MOD.....	16-18
NOISE WHINE CURE.....	24
MICROPHONE WIRING INSTRUCTIONS.....	26-32
PLL CHANNELIZER.....	33-40
ANTENNA SECRETS (K40 STUD MOUNT FOR BIG STICK).....	63-64
SPECIAL SECTION ON LINEAR AMPLIFIERS:	
50-70W MOBILE.....	66
300-400W BASE.....	67-69
70W BASE.....	70-71
EAGLE 200.....	72
EAGLE 500.....	73
CONVERSION FROM AMATEUR TRANSMITTER TO LINEAR AMP.....	74
LINEAR AMP PROBLEMS & SOLUTIONS.....	75-76

VOLUME 4

	PAGE #
HOW TO BUILD YOUR OWN RELAY MODULE.....	16
02A CHIP INFORMATION.....	54-55
HINTS & KINKS ON COBRA 62XLR & 142GTL.....	61
TURNER MIC EXPANDER (500WVC DISABLE).....	62
K40 BLINNIE.....	63
SUNSPOT PREDICTION CHART.....	64
LINEAR REPORT SECTION:	
D & A MAVERICK.....	65
D & A 500 TRIPLE CONVERSION.....	65
EAGLE 515 MODIFICATION.....	66-67
UNIDEN SSB 10METER POWER CONVERSION.....	68-70
SUPER CLARIFIER DIODE.....	71

VOLUME 5

	PAGE #
10 METER CONV. MICROCOMPUTER (MICROMONITOR PLL).....	1-5
ECHO BOX.....	6
250 WATT DUMMY LOAD - "SECRET CB'S LITTLE DUMMY".....	7
BUILT IN POWER MIKE.....	8-9
5-MILE SIMULATOR.....	10
RECEIVER PRE-AMP.....	11
GLEN DIGITAL CONTROLLER.....	12-13
GETTING SWR DOWN ON BASE ANTENNAS.....	15
APARTMENT ANTENNA.....	16
GROUNDING MOBILE RADIOS.....	17
OOPS! WE GOOPED!	
VOL. 1, PAGE 23.....	18
VOL. 2, PAGE 20 & 21.....	18
VOL. 3, PAGE 4, 7, 11, 25, 33.....	18
VOL. 4, PAGE 5, 45, 50.....	17

VOLUME 5 (cont.)

	PAGE #
DAK MARK IX POWER MODIFICATION.....	21-23
SUPER POWER MODULATION MOD. FOR BOWMAN BASE CBH990..	43
THE ART OF WIDEBANDING 858 CHIP.....	44
CONVERSION KIT + MARS & CAP FOR SSB.....	48-49
CONVERSION OF AM/SSB TO 10 METER AMATEUR.....	52
REDCO UFO INSTALLATIONS.....	61-69
HINTS & KINKS - COBRA 140/142/148GTL REGULATOR	
IC SHORTING OUT.....	70
SLIDE INCREASE, ALL SSB RADIOS.....	71
RADAR COMMUNICATOR.....	72-73

VOLUME 6

	PAGE #
PLL CRYSTAL CROSS REFERENCE GUIDE.....	1-2
SECRET CB TEST TONE.....	13
ERRONEOUS SIGNAL LOCATOR.....	14
LOW COG AMATEUR CONVERSION FOR 10 METERS.....	15
BASE ANTENNA GROUNDING.....	16-17
SUPER CLARIFIER 10-TURN POT.....	22
OOPS! WE GOOFED!	
VOL. 5, PAGE 19, 20, 28.....	25
THUMBWHEEL 200 CHANNEL CONVERSION FOR 858 CHASSIS..	31-34
REDCO UFO APPLICATIONS.....	40-52
SPECIAL SECTION ON LINEAR AMPLIFIERS:	
PDX 400.....	54
D & A MAVERICK 250.....	55
MACO DJSTER 300, 750 & 1000 TRANSMITTER.....	56-57
MACO 75.....	58
500 CX & 700 CX 10 to 11 METER CONVERSIONS.....	58
RDX-75.....	59
HDX-50.....	59
MDX-200.....	60
PDX-400.....	61
10 METER EXPERIMENTER BOARD INFORMATION.....	62-63
HOW TO MAKE CYBERNET CHASSIS SLIDE.....	65
HOW TO HOOK UP GLEN 310 TO PRESIDENT WASHINGTON....	67
SUPER CLARIFIER HINTS.....	66
REDCO DX-50.....	68-70

VOLUME 7

	PAGE #
HOW TO MAKE YOUR EAGLE SCREAM.....	14
IMPROVED SLIDE MODIFICATION FOR 02A SSB RADIOS.....	42
UPDATED 200 CHANNEL AMATEUR CONVERSION FOR 858 CHIP	43-48
10 METER CONVERSION FOR SSB RADIOS USING MB8719.....	49-50
HOW TO MAKE YOUR 858 CHASSIS SLIDE.....	56
LINEAR AMPLIFIER NOTES.....	57
RECEIVE AMP - SILTRONIX.....	58-59
ECHO BOX SPEECH PROCESSING FOR TRC-449.....	60
ADDING PING.....	61
CORRECTION TO THUMBWHEEL 200 CHANNEL CONVERSION....	62-63
MICROMONITOR TECH NOTES.....	64-69
MICROMONITOR INSTALLATION for RADIOS USING 858.....	70-71
AMP FOR RF PROBE.....	72
OSCILLOSCOPE MOD. FOR RF & MODULATION DISPLAY.....	73
THE "BANDIT" ANTENNA.....	74-76
SECRET CB'S OWN "TROUBLESHOOTER".....	77

VOLUME 8

	PAGE #
WHAT'S NEW ON THE ELECTRONICS HORIZON?.....	1-6
UHF FM CB (GMS).....	7-10
UNIDEN MB8719 PLL CHIP FREQUENCY CONVERSION.....	15
FREQUENCY MOD. FOR J.C. PENNEY, COLT, LAFAYETTE,	
HYGAIN, ETC.....	18
BROWNING MARK IVA MOD. & UFO INSTALLATION.....	22-23
BROWNING MARK IV TRANSMITTER TROUBLESHOOTING.....	25-32
OOPS! WE GOOFED!	
VOL. 5, PAGES 31, 32, 33, 34.....	41
VOL. 7, PAGES 31, 37.....	42-43

VOLUME 8 (cont.)

	PAGE #
LINEAR AMPLIFIER NOTES:	
INSTALLING & TROUBLESHOOTING LINEAR AMPS.....	47-49
10 METER AMP BOARD MOD. TO UPRIGHT DRIVER.....	50
YOU CAN BUILD IT:	
TWO-TONE GENERATOR.....	51
YAESU 601 (B) FREQ. COUNTER MOD. TO READ	
CB LOW, MIDDLE, HIGH FREQ.....	52-54
RF TEST METER.....	56-57
REDCO UFO MODIFICATION (FROM 20 to 29.995 MHz)....	55
SECRET CB'S POWER VECTORING.....	58
HOW THE ECHO BOX CAN ACTUALLY SURPASS THE POWER	
OF A LINEAR IN SSB.....	59
MICROMONITOR QUESTIONS.....	60-62
MICROMONITOR INSTALLATION INSTRUCTIONS:	
SMS104 PLL.....	63-64
ICOM 225.....	65-67
NEW PRODUCT RELEASE:	
ZAPPER 9000 MOD. & REFERENCE CHART.....	68-69
REDCO DIGI-SCAN UFO ELITE.....	70
CHOPPER CHARLIE ANTENNA, MODEL 64#5.....	71
TROUBLESHOOTER.....	73
AMATEUR VSB-1 (VOICE SIGNAL BOOSTER).....	82

VOLUME 9

	PAGE #
SSB'ER LOSE OUT AGAIN.....	1
FCC ANNOUNCES PLANS FOR SIDEBAND.....	2-3
FCC DELAYS NPRM: SSB FREQS. DOUBTFUL.....	3-4
SPEED-O-MATIC "SPEEDO-1" X-BAND RADAR GUN.....	5-6
CONVERSION TIPS FOR ALL SSB RADIOS.....	7
RELAY CRYSTAL SWITCHING.....	25-26
LETTER FROM A FRIEND.....	27-28
HINTS & KINKS-ELECTRONIC CRYSTAL SWITCHING.....	29
OOPS! WE GOOFED! VOL. 8, PAGE 17.....	29
SOLVING T.V.I.....	40-42
RADACRUS.....	42
IMPORTANT FACTS ABOUT ECHO BOXES.....	43-44
OOPS! WE GOOFED! VOL. 4, PAGE 51.....	44
VOICE SIGNAL BOOSTER (VSB-1) INSTALLATION.....	45-48
POWER SUPPLY MODIFICATION FOR REALISTIC PRE-AMP	
NOISE-CANCELLING MIKE #21-1175.....	49-50
HINTS & KINKS - SWITCHABLE MODULATION INCREASE....	51
RF ATTENUATOR.....	52-54
PRESIDENT SERVICE BULLETINS.....	55-61
INDEX VOLUMES 1 THRU 8.....	62-70

VOLUME 10

	PAGE #
SECRET CB TROUBLESHOOTER.....	2-4
VOICE SIGNAL BOOSTER - VSB-1.....	5-19
REPLACING MB8734 with MB8719.....	35
uPD2816C PLL PIN OUT.....	42
TECH TIPS ON 858.....	55
UNCONVERTIBLE CHIP LIST.....	66
LINEAR SUGGESTIONS.....	68-69
ZAPPER 9000 INSTALLATION HINTS.....	70
OOPS! WE GOOFED!	
VOL. 3, PAGE 33.....	71
VOL. 5, PAGE 24, 28, 48.....	72
VOL. 8, PAGE 16, 17.....	72-73
VOL. 9, PAGE 9, 51.....	74-75
VOL. 9, PAGE 29.....	72
CB PARABOLIC TYPE ANTENNA.....	77

VOLUME 11

	PAGE #
CPI ALC MODIFICATION FOR INCREASED SSB POWER.....	9
HOW TO ADD RF GAIN CONTROL TO A CPI 300/400.....	11
VSB-1 UPDATE.....	25-26
NEW FRONTIER: FM CB.....	27-29
NEW PRODUCT: DIGI-SCAN DS-400.....	30-31

	PAGE #
COMING ATTRACTIONS - SERIAL DATA/PLL	
FREQUENCY SYNTHESIZERS.....	32
UNCONVERTIBLE AT THIS TIME -GE 3-5900A TC9101P....	33
ADD CH. 9 & 19AT TO COLT 210.....	33
TAPPER 9000 INSTALLATION UPDATES.....	34
RADIO MODULATION ADJUSTMENTS FOR VARIOUS MODELS... 51-53	
HINTS ON SERVICING.....	54
SERVICE NOTES-GOLDEN EAGLE MARK IV TRANSMITTER....	55
D104 & D104M6 ASTATIC MIKE MODIFICATION.....	55
HOW TO SOLVE NOISE PROBLEMS.....	56-57
MORE ON THE "TROUBLESHOOTER".....	57
NOISE IN DIESEL TRUCKS.....	58
IN HOUSE VALUE LISTING.....	59
TRUCKERS SPECIAL POLARITY PROTECTOR WITH SMARTS... 60	
HOW TO BUILD:	
LOW PASS FILTER.....	61
20dB ATTENUATION PAD.....	61
BALLU COIL.....	62
1000Hz TONE.....	63
ADD A SECOND BATTERY.....	64
20 AMP POWER SUPPLY.....	65
SIGNAL INJECTOR.....	66
CMOS LOGIC PROBE.....	67
REFERENCE OSC-DIVIDER.....	68
READOUT MODIFICATION.....	69
ASTATIC MIC MOD.....	70
BILATERAL SWITCH.....	71
PLL PINOUT DIAGRAMS.....	72-77
THE "BANDIT" ANTENNA.....	53
OOPS! WE GOOFED!	
VOL. 3, PAGE 25.....	78
VOL. 6, PAGE 32.....	78
VOL. 7, PAGE 43, 53, 63.....	78
VOL. 8, PAGE 52.....	78
VOL. 10, PAGE 2.....	78

VOLUME 12

	PAGE #
SIMPLE CURE FOR RX-TX TRACKING PROBLEMS.....	21
NAM RADIO CRYSTAL SELECTOR GUIDE.....	24
VSB-1 HOOK-UP:	
TEABERRY STALKER XX.....	25
REALISTIC TRC-490.....	25
WARDS GEN-719A.....	25
MODULATION ADJUSTMENTS FOR VARIOUS REALISTICS.....	33
TAPPER 9000 REFERENCE CHART.....	46
TAPPER TROUBLESHOOTING HINTS.....	47-48
TC9106 PLL OPERATION ANALYSIS.....	50-53
THE "SPREAD EAGLE" ANTENNA BREAK-THRU FOR TRUCKERS. 54-55	
BASIC PLL.....	56
ELECTRONIC TERMINOLOGY.....	57
SCANNER PROGRAMMING TIPS.....	58
INTO THE KNOW WITH JAPANESE SEMICONDUCTORS.....	59
TRANSISTOR SPECIFICATIONS.....	60
RESISTOR COLOR GUIDE.....	61-62
CAPACITOR CODES.....	62
YOU CAN BUILD IT:	
"SECRET C3" & "SUPER-DUPER POWER	
SUPPLY CONTROLLER.....	63
AUDIO TEST STATION.....	64
POWER LINE FILTER - T.V.I. FILTER.....	65
OOPS! WE GOOFED!	
VOL. 4, PAGE 38.....	66
VOL. 10, PAGE 10, 16, 28.....	66
VOL. 11, PAGE 3, 10, 15, 16, 71.....	66
INDEX VOLUMES 1 THRU 11.....	67-78

VOLUME 13

	PAGE #
INTRODUCING THE SOMMERKAMP TS-7880X.....	4-9
NB8719 PINOUT.....	32
AGC SELECTOR SWITCH.....	38
CYBERNET 02A CHASSIS.....	39
HOW TO HOOK UP A 10 TURN POT TO 2000 CTL.....	40
2824C OPERATION ANALYSIS.....	41-43
VSB-1 HOOK-UP: TRC-448 & MIDLAND 77-0004 4001....	43-44
TROUBLESHOOTING CLARIFIER PROBLEMS ON THE 858....	45-47
SUPER REGULATOR.....	48
BUILD A RECEIVER PREAMP.....	49
LINEAR NOTES.....	50-51
MODULATED GUNN OSCILLATOR.....	52-56
CYBERNET 02A AM POWER INCREASE.....	59
REALISTIC DX300 (20-204).....	64
BEARCAT 250.....	65
OOPS! WE GOOFED!	
VOL. 4, PAGE 39.....	66
VOL. 6, PAGE 3 & 12.....	66
VOL. 7, PAGE 54.....	66
VOL. 10, PAGE 25 & 48.....	66-67
VOL. 11, PAGE 4, 5, 10, 41, 75.....	67
INDEX VOLUMES 1 THRU 12.....	68-80

VOLUME 14

	PAGE #
NB8719/11.3258 TRUTH TABLE.....	15-17
NEW PRODUCT: FM-308 THRU-LINE FREQ. COUNTER.....	18-19
NEW! "KIT A" FOR LC7130/7131 & TC9106P	
CHIPS & INSTALLATION INSTRUCTIONS.....	20-40
BROWNING FING INFORMATION.....	41
25-29 MHz FREQUENCY ASSIGNMENTS.....	62-63
ELECTRONIC TERMINOLOGY.....	63
YOU CAN BUILD IT!	
FET RECEIVER PRE-AMP.....	64
BUILD YOUR OWN SPACE SOUND.....	65
BUILD AN AMPLIFIER.....	66-67
INDEX FOR VOLUMES 1 THRU 13.....	68-80

VOLUME 15

	PAGE #
NEW MICROSCAN PLUS SYSTEM.....	5-6
BREAKING THAT CHIP.....	7-11
02A TRUTH TABLE.....	12-13
MEASURE FREQUENCY ON SCOPE.....	17
PM77 POWER MODULATOR KIT.....	19
DIGITAL PROCESSOR KIT/uPD2024.....	28
WIRE GAUGE CONVERSION CHART.....	41
02A 23 CHANNEL AM MOD.....	59
POWER MOD. FOR AM UNITS.....	65
PRE-CONVERSION TIPS.....	70
CONVERT A SALVAGED METER TO VOLT METER.....	71
STATE/INTERNATIONAL DESIGNATORS.....	72
OOPS! WE GOOFED!	
VOL. 12, PAGE 7.....	69
VOL. 13, PAGE 63.....	69
VOL. 14, PAGE 12.....	69
INDEX FOR VOLUMES 1 THRU 14.....	73-79

VOLUME 16

VSB-1 (COBRA 2000) UPDATE.....	6
SAMS CB MANUAL - OUT OF PRINT.....	7
CALL SIGNS/FREQUENCY CHARTS.....	9-20
HINTS/KINKS/GOOFS.....	31
M58472P PLL CHIP MOD.....	33
OSCILLATOR CHECKER, LOW CAPACITY PROBE.....	34
TROUBLESHOOTER GUIDE.....	35-36
INTO THE KNOW WITH POTS.....	37
"MY WAY" SLIDE.....	38
BLEED-OVER FILTER.....	40
LOOP FILTER - WHAT IS IT?.....	42
COLOR CODE GUIDE FOR CHOKES.....	42
ANTENNA INFORMATION.....	56
O2A CLARIFIER/BANDSWITCH MOD.....	57-59
HIGH CURRENT METER.....	63-64
SWR VS REFLECTED POWER CHART.....	65
CUSTOM FREQUENCY STANDARD.....	66-67
CHECKING MODULATION.....	69
DIGITAL PROCESSOR KIT (#146) UPDATE.....	70-71
OOOPS! WE GOOFED!	
VOL. 1, PAGE 61.....	72
VOL. 12, PAGE 28.....	72
VOL. 13, PAGE 27.....	72
VOL. 14, PAGE 22, 41.....	72
VOL. 15, PAGE 63, 65.....	72
INDEX FOR VOLUMES 1 THRU 15.....	73-80

VOLUME 17

	PAGE #
'B' KIT.....	4-33
SCB KIT #106 FOR TRC-451.....	36-38
M58472P PLL CHIP (UPDATE).....	39
HINTS/KINKS/GOOFS.....	46
U-BUILD IT, BURGLAR ALARM.....	48
U-BUILD IT, CUSTOM REGULATED P/S.....	49-50
GYPSY FREQUENCY CHART/KIT INFO.....	51-52
PLL CHIP INFO.....	59
REALISTIC PRO-54 SCANNER (D. C. MOD.).....	62-64
VIDEO "DUBBING/COPYING" TIPS.....	64-65
VCR VIDEO MOD. TRS-80 VIDEO DISPLAY.....	66-69
OOOPS! WE GOOFED!	
VOL. 4, PAGE 54.....	70
VOL. 15, PAGE 58.....	70
VOL. 16, PAGE 50.....	70
VOL. 16, PAGE 72.....	70
INDEX: VOL. 1-16.....	71-78
OOOPS! WE GOOFED! INDEX.....	78
CROSSWORD PUZZLE.....	79

"OOOPS! WE GOOFED!" INDEX

ORIGINAL VOLUME	PAGE #	CORRECTION IN VOLUME	PAGE #
1	23	5	18
1	61	16	72
2	20,21	5	18
3	4,7,11,25	5	18
3	25	11	78
3	33	5	18
3	33	10	71

ORIGINAL VOLUME	PAGE #	CORRECTION IN VOLUME	PAGE #
4	5	5	17
4	38	12	66
4	39	13	66
4	45,50	5	17
4	51	9	44
4	54	17	70
5	19,20	6	25
5	24,28	10	72
5	28	6	25
5	32	8	41
5	48	10	72
6	3,12	13	66
6	31-32	7	62-63
6	32	11	78
7	31	8	42
7	37	8	43
7	43	11	78
7	49	10	25
7	53	11	78
7	54	13	66
7	63	11	78
8	16-17	10	72-73
8	17	9	29
8	52	11	78
9	9	10	74
9	29	10	72
9	51	10	75
10	2	11	78
10	10,16	12	66
10	25	13	66
10	28	12	66
10	48	13	67
11	3	12	66
11	4,6	13	67
11	10	12	66
11	11	13	67
11	15,16	12	66
11	41	13	67
11	71	12	66
11	75	13	67
12	7	15	69
12	27,28	16	72
13	63	15	69
14	12	15	69
14	22,41	16	72
15	58	17	70
15	63,65	16	72
16	50	17	70
16	72	17	70



CORRECTIONS

KIT-27A: Note, 2 different production runs have been found on this unit! discrepancy is in Pin-10. CAUTION: Ground is sometimes taken from pin 18 by a wire running under the chip to pin 10, and must be removed. On the other run pin 10 must be isolated by cutting etch in two places.

Volume 9, page 12: Step 3, DELETE all reference to removal of C34. Replace CR4 with a Super Diode is correct.

Volume 7, page 28: All the Fo's should have a 0 for the last digit-CHANGE. On this PLL chip the even's come out when converting due to the chip's ROM code converter.

(*) Volume 10, page 49: This modification was drawn up wrong, I know as sent it in myself. The correction to drawing is below.
NOTE: Custom Conversion #18 is available from Selman Enterprises on this unit (26.525-27.795MHz).

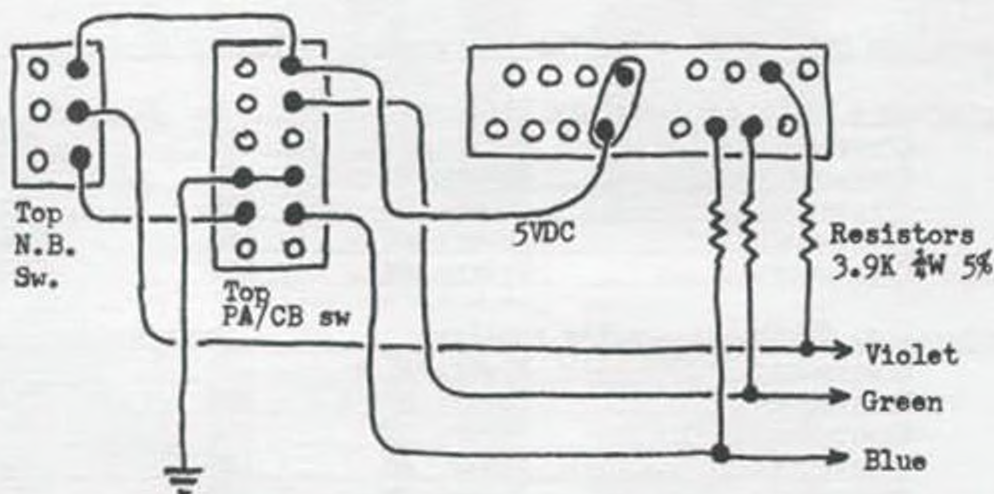

These wires are from the PLL cage.....

(*) Permission granted to Copy this correction and place in Volume 10.

See Page 62, this volume - for additional correction: Volume 5, page 47.

Manufacturer/Model: _____ Serial Number: _____Trouble Described: _____

_____Trouble Found: _____

_____Work Requested-Besides Repair: _____Frequency Modification: _____Variable Transmit Frequency Capability: _____Frequency Chart: _____ Instruction Sheet: _____Internal Power Supply Modification: _____ Alert: _____ Disable: _____Re-written Owner's Manual: (Must have original): _____Performance Check-out---before repair: _____ Modulation: _____

Frequency:	Power: AM	LSB	USB
Frequency:	Power: AM	LSB	USB
Frequency:	Power: AM	LSB	USB
Frequency:	Power: AM	LSB	USB
Frequency:	Power: AM	LSB	USB

Performance Check-out---after repair: _____ Modulation: _____

Frequency:	Power: AM	LSB	USB
Frequency:	Power: AM	LSB	USB
Frequency:	Power: AM	LSB	USB
Frequency:	Power: AM	LSB	USB
Frequency:	Power: AM	LSB	USB
Frequency:	Power: AM	LSB	USB

ALL CHECK-OUT DONE ON DUMMY LOAD...Operation check on authorized Freq-ONLY.Parts: _____

_____**Repair Date; any warranty refers from this date; not pick-up date!!!Cost-Parts: _____ Cost-Labor: _____ Total-CASH: _____**Labor Warranty (Sealed Unit Only): _____



Volume 1



Volume 2



Volume 3



Volume 4



Volume 5



Volume 6



Volume 7



Volume 8



Volume 9



Volume 10



Volume 11



Volume 12



Volume 13



Volume 14



Volume 15



Volume 1 & 2



Volume 16



Volume 17



Volume 18

