

LIBRARY OF CONGRESS
SERIALS ACQUISITION
JAN 21 1982
FOLIO 11
PW 812-605

SECRET

CB

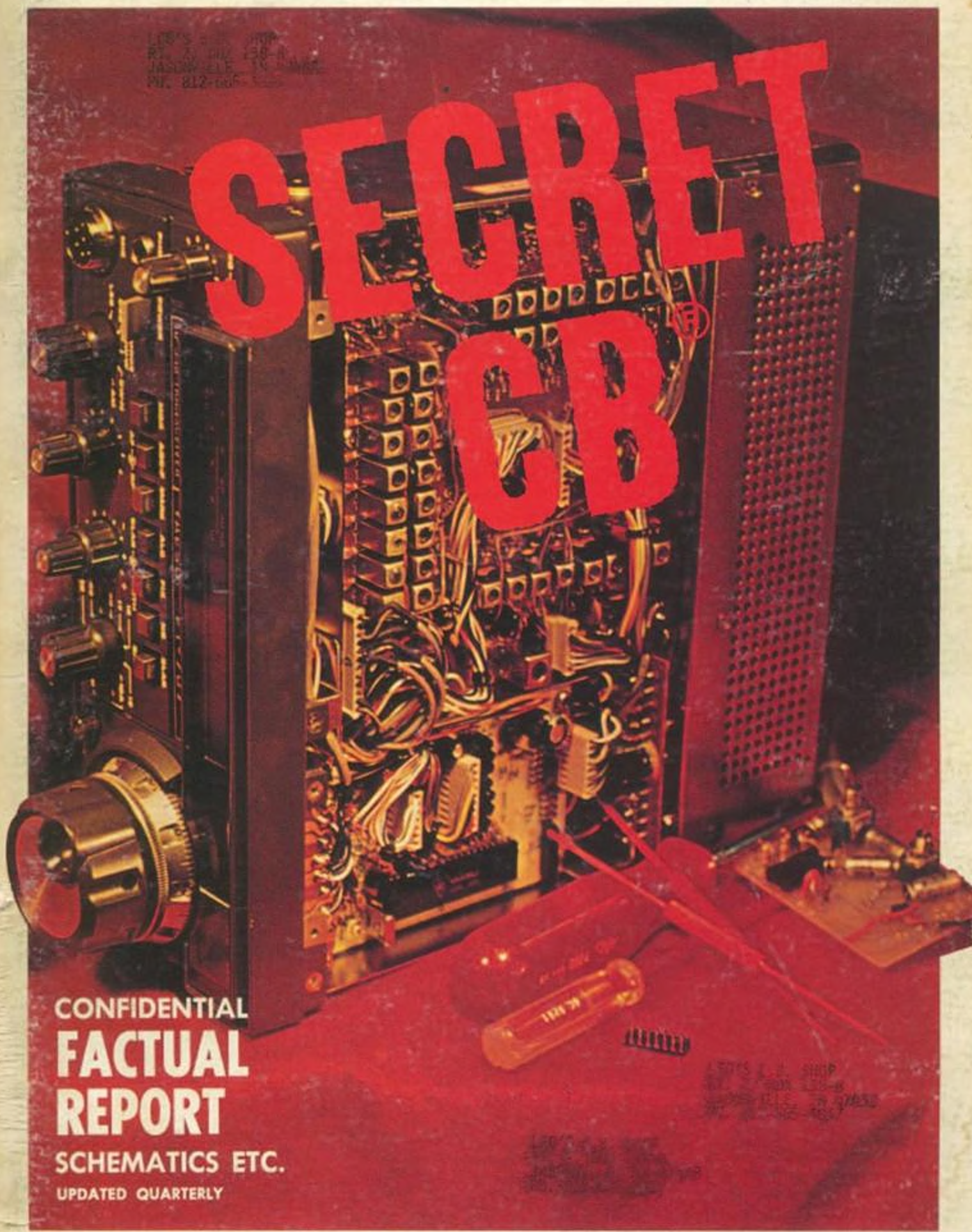

CONFIDENTIAL
FACTUAL
REPORT
SCHEMATICS ETC.
UPDATED QUARTERLY

LIBRARY OF CONGRESS
SERIALS ACQUISITION
JAN 21 1982
FOLIO 11
PW 812-605

LEO'S C.B. SHOP
RT. 2, BOX 158-B
JASONVILLE, IN 47438
PH. 812-665-3837

IMPORTANT: READ THIS FIRST

The information in this book is not to be used to exceed F.C.C. specifications, in any case, as applied to power, modulation, frequency spectrum, etc. It is illegal to do this to any CLASS D RADIO.

This book is a factual report of gathered information, and as such is intended for use on radios for EXPORT ONLY.

If you are not familiar with electronics, it is better to check for advice with your local electronics or CB center, as to restrictions, etc., concerning your radio.

More information, on other units will be forthcoming in future issues, to be published on a quarterly basis.

This book will not be found at a book store, but can be obtained through your local CB Dealer or Distributor, or by completing the order form in the book and sending to:

Selman Enterprises, Inc.
P.O. Box 8189
Corpus Christi, Texas 78412

Secret CB
Volume Ten
Published April 1981

Copyright 1981. All rights reserved in the United States and most foreign countries.

New issues quarterly

Address any and all inquiries to:

Selman Enterprises, Inc.
P.O. Box 8189
Corpus Christi, Texas 78412

(512) 992-1303

ACKNOWLEDGEMENTS

SECRET CB WISHES TO GRATEFULLY ACKNOWLEDGE THE FOLLOWING PEOPLE FOR THEIR HELP AND CONTRIBUTIONS TOWARD GETTING VOLUME 10 IN PRINT, THEIR ENCOURAGEMENT AND CONTRIBUTION OF MATERIAL HAS BEEN INVALUABLE.

MICHAEL T. AYERS

JOHN CROOKSHANK

CHARLES DUNBAR

JERRY MILLS

JOE SCHLEIN

JOE TAMARO

WILLIAM "TRADER BILL" WENTZ, JR.

DONALD E. WOLFE

STEVE URICH

LEO'S C.B. SHOP
RT. 2, BOX 158-B
JASONVILLE, IN 47438
PH. 812-665-3837



**Rod says "thanks" and
a free book to the above
people**

INTRODUCTION

Advances in the single side band world of electronics are still going strong.

The VSB-1 is probably the most advanced idea of it's kind in this area. Originally built for processing digital speech for scrambling, the VSB-1 came to be developed strickly by accident. When a person fully understands how well the VSB-1 performs, it becomes a must for those who want the final punch of clean power for their SSB rig. It is also being widely used in AM units with great success. If you haven't tried it yet- well, all that can be said is "Try it, you'll LIKE it"! We have included in this issue comprehensive hook-in instructions to make the interfacing painless.

Satellite T.V. still seems to be the hottest item going. Already, this promises to be the most challenging field ever. If you haven't ordered a copy of our satellite primer, "Secrets of Satellite T.V." yet, you don't know what you're MISSING!

I would also like to express my sincere appreciation to VIC, our Engineering Technician for the super job he has done since we first started in 1977. Many of you have gotten to know him over the telephone. We would also like to thank all of our good readers who have contributed information to Secret C.B. A wealth of information exists in these pages, so we hope that even one page may benefit you or cause you to come up with a fantastic idea of your own.

To all who read Secret C.B., and Secrets of Satellite T.V., we wish to thank you again and keep those ideas coming.



83's

TABLE OF CONTENTS

	<u>PAGE #</u>
Letter From Vic	1
Secret CB's Trouble Shooter	2-4
Voice Signal Booster- "VSB-1"	5-19
CONVERSIONS:	
How to put your Yaesu FT707 on 11 Meters	20-24
MB8719 Standard Modification	25-27
President Washington MB8719 (11.1125)	28-29
President McKinley (1011001) 8719 w/11.1125	29
President Madison 1010002 MB8719 w/11.3258	30
Tram D80 MB8734 w/11.3258	30
Realistic TRC 450 (MB8734 chip)	31
Realistic TRC 459	32-35
Realistic TRC 457	36
Realistic TRC 480	37-38
Teaberry Stalker XV	39
Teaberry Stalker XX	40
AR144/146GTL UPD 2824C PLL	41
AR144 UPDATE	42
Cobra 135XLR TC5080P UPDATE	43-44
Tram D62, Cobra 132XLR, 135XLR, UPDATE	45-46
Craig L232, L132 UPD 2824C	47
G.E. Superbase 3-5875A	48
Johnson 242-4730	49-51
Sears 934.38260700	52
Courier Centurion 40D	53
Tram D201A UPDATE	54
Tech Tips on the 858 Chasis	55
Sears 562.38220700; Tram D12	56
Panasonic RJ3600	57
Specific Radio Tune-ups	58-65
Unconvertable chip list	66
Modulation Adjustments for New Radios	67
Linear Suggestions	68-69
Zapper Installation Hints	70
OOPS, WE GOOFED:	71-75
Volume 3 page 33	71
Volume 5 page 24, 28, & 48	72
Volume 8 page 16	72-73
Volume 8 page 16 (148GTL)	73
Volume 9 page 9	74
Volume 9 page 51	75

LETTER FROM VIC

We want to take this opportunity once again to thank everyone of you guys who send us information. This has truly helped us keep up with what goes on in the different shops and shacks around the country. Also, thanks to the many customers who send us schematics and service manuals on new sets you run across which are not yet into the Sams CB Radio Service Data. Our offer still holds that we will send you a free volume in which your contribution was printed. Sometimes we receive info that is hard to decipher, and we finally either figure it out or we have to write back to the contributor for more clarification. PLEASE, type or print instructions and include drawings or sketches of switch connections, chip connections, etc. We can always rewrite and condense, but it is not easy to add from info. not personally obtained, and just shy of coherent. Also, we receive tons of mail and we try to answer all the technical problems, but please, include a self addressed stamped envelope, so we can continue to provide this service.

We would like to include some really HOT linear information for export use on 11 meter, so if you run across a fantastic design in a model, let us know. Also we would like to publish a complete, tested set(s) of plans for the do-it-yourselfer.

Have you taken a look at the new SAMS CB RADIO SERVICE DATA Publication? We thought SAMS was doing a fantastic job lately, but can you believe Volume "CB 291"? No more circuit trace or easy to read schematics- just what is available from the manufacturer. Needless to say, sometimes that can leave alot to be desired. All this, and a higher price too! Haven't we come to expect alot more than this from SAMS?

What would you like to see in future issues? Direct you comments to me.

Yours Truly,



Vic Richter

SECRET CB's TROUBLESHOOTER KIT RELEASED

Due to popular demand, "THE TROUBLESHOOTER" will be available as a kit, instead of a factory assembled unit. This test instrument will be offered in two basic forms:

- 1) The "KWIK KIT". Contains all parts to complete the construction of THE TROUBLESHOOTER (except case, and knobs).
Includes: IC's, sockets, resistors, capacitors, PC boards, front decal, rubber gasket, and switches.
- 2) The "SEMI-KIT". Contains PC boards, front decal, and rubber gasket. Any other parts needed to complete the kit, are available from SECRET CB individually by part number.

THE TROUBLESHOOTER is a dynamic and extremely useful test instrument, and will be a welcome companion at your test bench.

If you need more persuasion, this is an idea of what the unit is.

- 1) THE TROUBLESHOOTER provides a two tone oscillator for tuning single side band and a single tone for tuning AM.
- 2) While tuning, by plugging a set of common stereo headphones into THE TROUBLESHOOTER, it provides a sidetone to hear how you sound on the air!
- 3) THE TROUBLESHOOTER can also be used to check two radios, 5 and 20 miles away! What an asset when trying to get distortion out of a set!
- 4) THE TROUBLESHOOTER can also be used as a dummy load with intermittent use up to 100 Watts (25 W rating).



TONE GENERATOR SCHEMATIC

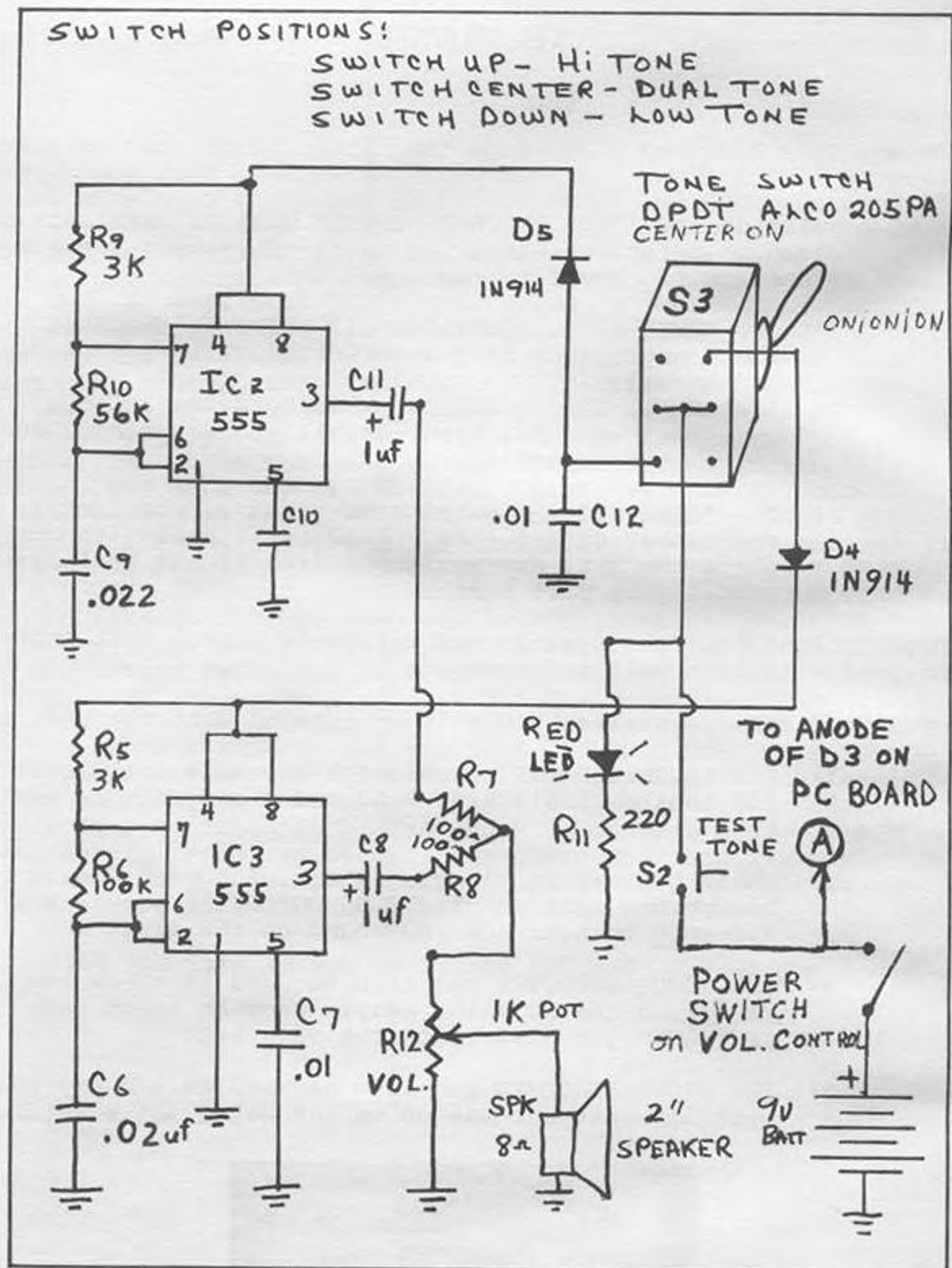

DETECTOR CIRCUIT

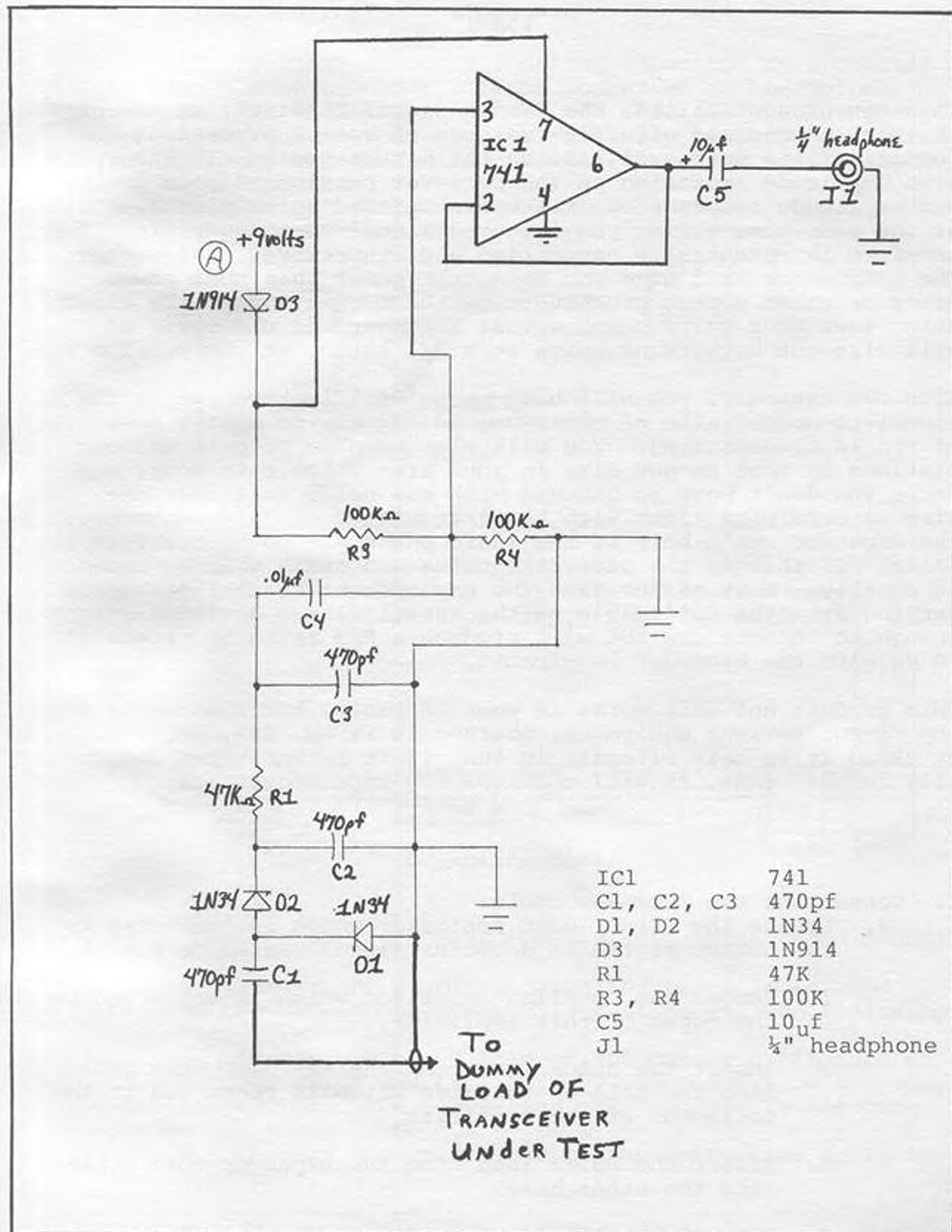

VOICE SIGNAL BOOSTER

"VSB-1"

This new product called, the "Voice Signal Booster", is one of the most unique and effective methods of speech processing for communications gear available on the market today. It incorporates amplitude expansion on the receiver portion of your radio, and amplitude compression of the transmitted voice signal, while at the same time giving you improved signal-to-noise ratio. The waveform is essentially unmodified and, therefore, undistorted. The compressor will give you more talk power than most power mikes or other speech processors on the market today, the effect being that your voice comes across stronger and clearer. It will also cut background noise at a 2/1 ratio, at the receive end.

With the expander, you will have up to 16dB improvement in the signal-to-noise ratio of the received signal, no matter what type of rig is transmitting. You will also be able to pull distant stations in that no one else in your area is able to hear, because you don't have to contend with the noise that everyone else is receiving along with the transmitted signal. However, the expander won't help if the audio peaks are no higher than the noise. If this is the case, the noise and audio will be expanded equally. Most of the time the expander makes an improvement varying from the noticeable to the spectacular. A signal strong enough to actuate the AVC will produce a S/N ratio in excess of 30 dB with the expander in circuit.

This product not only works in your CB radio, but also works in any communications equipment, whether it is AM, SSB, FM, UHF, or VHF. It is only illegal, in that if it is installed internally in the radio, it will void the FCC type acceptance.

INSTALLATION

I. Connecting the expander cable:

A. Locate the first audio amplifier which is connected to the output of the AM detector diode. Refer to Fig. 1.

1. Remove the coupling capacitor which is connected to the output of this amplifier.
2. Insert the BLACK lead from the expander coax cable into the hole on the side which is connected to the collector of the amplifier.
3. Insert the WHITE lead from the expander coax cable into the other hole.
4. Connect the shield wire of expander coax to the nearest common ground (usually a transformer shield).

VOICE SIGNAL BOOSTER INSTALLATION (Cont'd)

B. Connecting the expander cable when there is no coupling capacitor between the first audio amplifier and the volume control:

1) If there is not a coupling capacitor as indicated in Fig. 1, the expander will be connected at the volume control (see Fig. 2). Unsolder the shielded wire on the end of the volume control. Solder the wire which was lifted to the black expander wire. Solder the white wire on to the volume control.

2) Connect the shielded wire to ground.

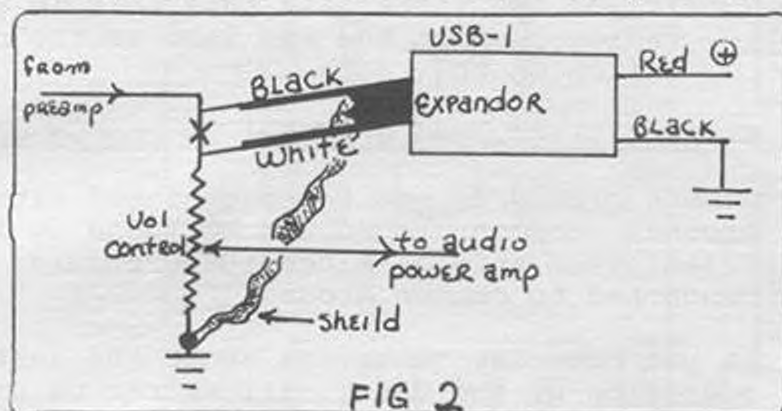

Note: Some models do not have a pre-amp between detector and Audio Power Amp. In this case, we suggest the purchase of our optional pre-amp, installed as in Fig. 3

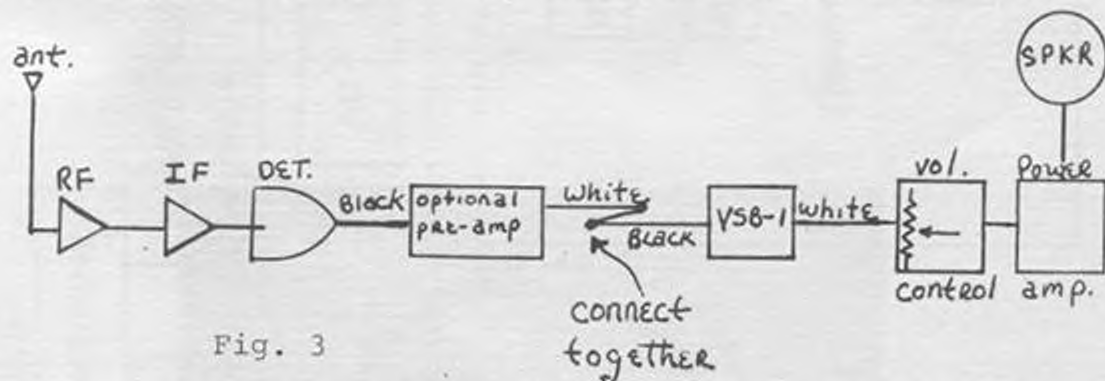

Fig. 3

II. CONNECTING THE COMPRESSOR CABLE: (blue coded leads)

A. Remove the coupling capacitor which is located between the microphone preamplifier stage and the following audio amplifier stage.

B. Insert the black lead of compressor cable into one of the holes which was left open by the removal of the coupling capacitor. The black lead must connect to the output of the transistor.

C. Connect the white lead of the compressor cable in the other hole.

VOICE SIGNAL BOOSTER INSTALLATION (Cont.)

D. Connect the coax shield wire to the nearest transformer shield.

III. CONNECTING THE POWER SUPPLY LEADS TO 12V DC SOURCE:

A. Connect the red lead of the module to +12 volts DC.

1. If you are installing this unit in a base station, connect the red lead to the closest +12 volt DC source.
2. If you are installing this unit in a mobile radio, connect the red lead to the on-off switch on the radio.

B. Connect black lead of VSB-1 to common ground of radio

CAUTION: Common ground is not to be confused with chassis ground. Common ground can be found by locating any transformer shield, since these shields are usually connected to common ground.

NOTE: If you have any questions about the installation or operation of the VSB-1 call Secret CB or write to us and tell us which radio you want to install the unit on and we can give you more specific instructions, that is, if your radio is not one that we have already listed in this article.

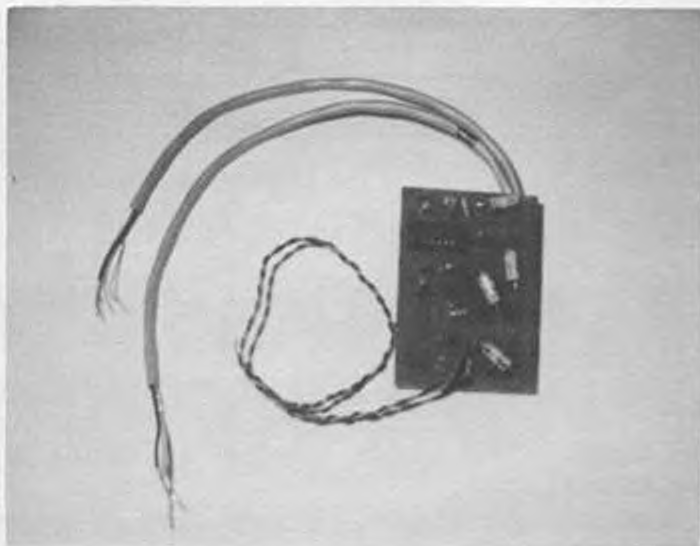

BLOCK DIAGRAM OF TYPICAL INSTALLATION

FIGURE 1

BLACK - INPUT
WHITE - OUTPUT

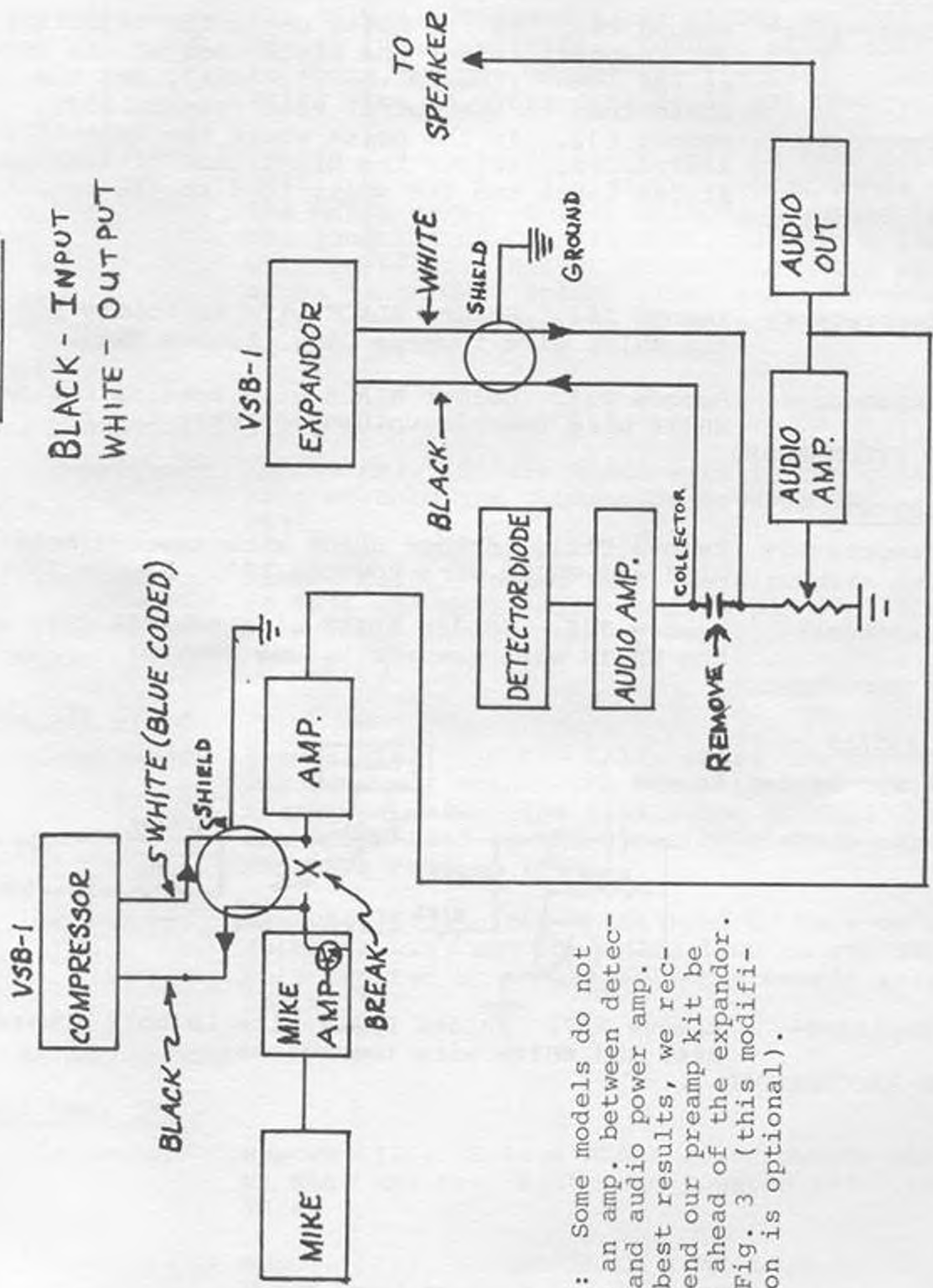

Note: Some models do not have an amp. between detector and audio power amp. For best results, we recommend our preamp kit be used ahead of the expander. See Fig. 3 (this modification is optional).

SPECIFIC INSTALLATION INSTRUCTIONS

FOR VSB-1

COBRA 25 GTL -

- Compressor- Remove C89. In the holes where the capacitor was removed, solder the black lead of the VSB-1 at the input (toward the mic jack), and the white lead to the output hole (toward R53).
- Expander- Remove C32. In the holes where the capacitor was removed, solder the black lead of the VSB-1 at the input and the white lead to the output.

PREAMP RECOMMENDED

COBRA 63 GTL -

- Compressor- Remove C53. Solder BLACK wire to hole by R57 and WHITE wire towards C55. Remove TR17.
- Expander- Remove R33. Solder BLACK wire towards C26 and WHITE wire towards volume control.

PREAMP RECOMMENDED

COBRA 89 GTL -

- Compressor- Remove C127. Solder BLACK wire towards hole at R102 and WHITE wire towards R57. Remove TR16.
- Expander- Remove R32. Solder BLACK wire towards C31, and the WHITE wire towards volume control.

PREAMP RECOMMENDED

COBRA 135XLR -

- Compressor- Remove Q21.

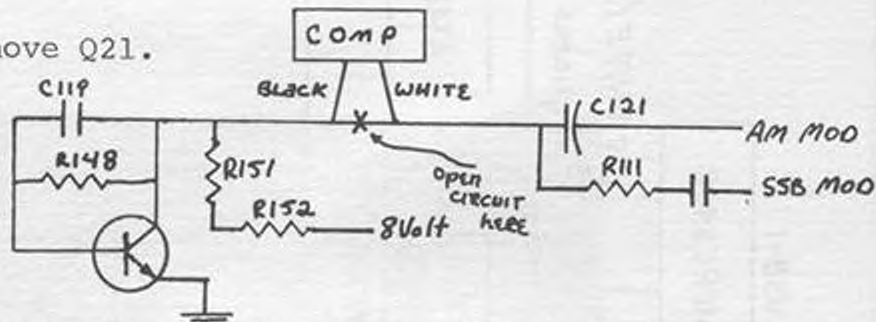

- Expander- Remove R67. Solder BLACK wire in hole towards R64, and WHITE wire towards R68.

PREAMP RECOMMENDED

SPECIFIC INSTALLATION INSTRUCTIONS (CONT)

FOR VSB-1

COBRA 138 XLR & 139 XLR -

Compressor- Cut cathodes (banded ends) of D21 and D22 diodes loose and lift. Connect BLACK wire to where cathode of D22 was (to C78). Connect WHITE wire to where cathode of D21 was (to C77).

Expander- Remove C80. Insert BLACK wire in hole next to R208. Obtain a 1N914 diode, solder anode to the WHITE wire. Solder cathode to other hole, the junction of C82-C84-R101. Obtain a 100K $\frac{1}{4}$ watt resistor. Solder one end to WHITE wire-anode junction. Solder other end to a short wire. Run the free end of wire to the cathode of D28, 9V RX, 0 TX source.

NO PREAMP

COBRA 140 GTL & 142 GTL -

Compressor- Remove C83. Solder BLACK wire to the positive side of hole and other side towards TR27. Remove TR32.

Expander- Remove C110. Solder BLACK wire towards collector of TR36 and WHITE wire towards pin 4 of IC4.

NO PREAMP

COBRA 148 GTL -

Compressor- Remove C101. In the holes where the capacitor was removed, solder the BLACK lead of the VSB-1 to the positive side (collector of TR23), and the WHITE lead to the other hole where capacitor was removed (TR22).

Expander- Remove C76. Solder BLACK lead to hole on side going to R93, and the WHITE lead to the other hole vacated by the capacitor (towards volume control).

PREAMP RECOMMENDED

COBRA 1000 GTL -

Compressor- Remove C127. Solder BLACK lead towards the hole at R102 and the WHITE lead towards R57. Remove TR16.

Expander- Remove R32. Solder BLACK lead towards C31 and WHITE lead towards volume control.

PREAMP RECOMMENDED

SPECIFIC INSTALLATION INSTRUCTIONS (CONT)

FOR VSB-1

COBRA 2000 GTL -

- Compressor- Remove C101. Install BLACK lead to positive side of cap, and install the WHITE lead to the other hole vacated by the capacitor.
- Expander- Break brown wire from volume control at the point where it connects to the P/C board. Connect the BLACK lead to this wire and the WHITE lead to the hole where the wire was removed. (See figures 2 + 3)

PREAMP RECOMMENDED

COLT 485 -

- Compressor- Remove C152. In the holes where the capacitor was removed, solder the BLACK lead of the VSB-1 on the side toward the mic jack and the WHITE lead in the other hole towards R131.
- Expander- Unsolder the violet/white wire leading from the volume control where it is connected to the P/C board. Solder the BLACK lead of the VSB-1 to the violet/white wire, and the WHITE lead into the hole vacated by the removed violet/white wire.

PREAMP REQUIRED

DAK X 276 -

- Compressor- Remove C152. Solder BLACK wire to hole by mic gain control and WHITE wire to hole by R131.
- Expander- Unsolder WHITE wire on volume control. Solder this wire and the BLACK wire from the VSB-1 together. Solder the WHITE wire from the VSB-1 to the volume control.

PREAMP RECOMMENDED

J.C PENNYS 6241 -

- Compressor- Cut collector of Q401 and cut loose one end of R405. Move cut end of R405 to collector of Q401.

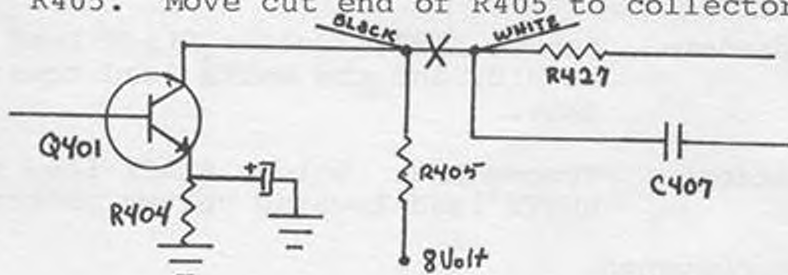

SPECIFIC INSTALLATION INSTRUCTIONS (CONT)

FOR VSB-1

J.C. PENNYS 6241 (cont)

Expander- Remove C263. Solder BLACK lead of expander to hole next to D257 and the WHITE lead towards PL 36.

NO PREAMP

J.C. PENNYS 6247 -

Compressor- Remove C152 and install BLACK lead of VSB-1 to the input and the WHITE lead to the output (R131) holes of where the capacitor was removed.

Expander- Break the violet/white wire coming from the volume control at the point it joins the P/C board. Solder the BLACK lead of the VSB-1 to this wire, and the WHITE lead to the board where you unsoldered the violet/white wire (See figures 2 + 3).

PREAMP RECOMMENDED (Remove Q35, modulation limiter)

J.C. PENNYS 6248 -

Compressor-

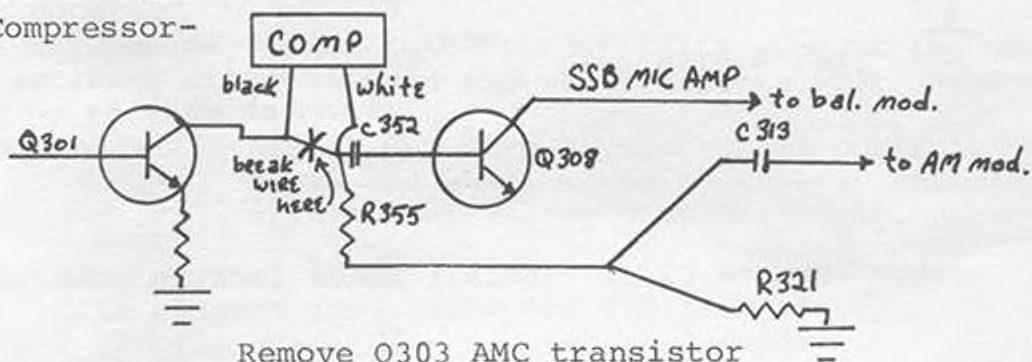

Remove Q303 AMC transistor

Expander- Remove C311 capacitor. Connect BLACK lead to the positive side of C311. Connect WHITE lead to one side of C312.

NO PREAMP

JOHNSON 4120 -

This unit requires the use of a 4PDT relay.

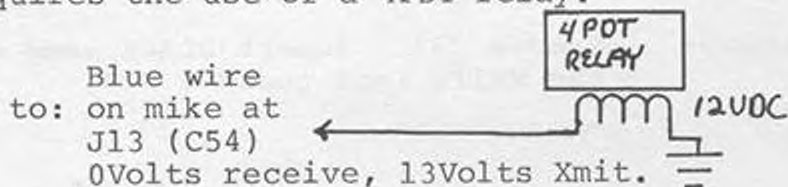

SPECIFIC INSTALLATION INSTRUCTIONS (CONT)

FOR VSB-1

JOHNSON 4120 (cont)

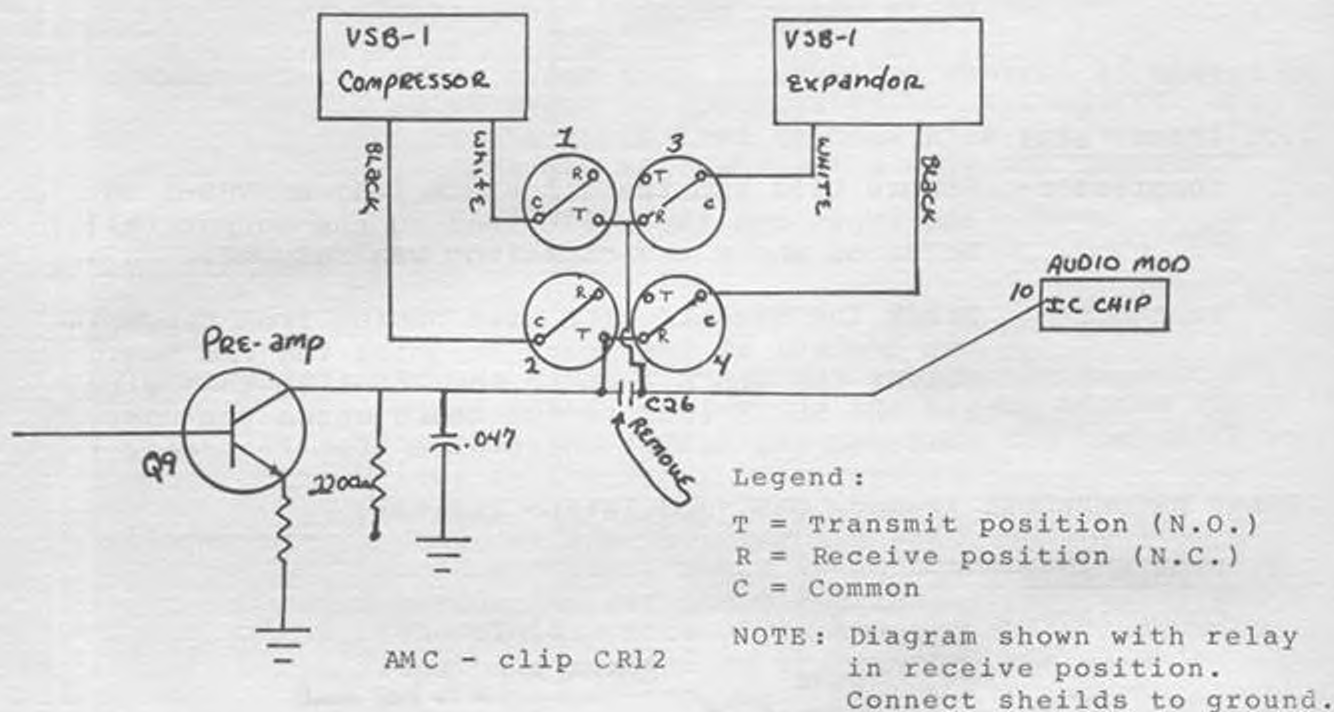

KRACO KCB2340 -

Compressor- Remove C234. Install BLACK lead in hole towards pin 6 of IC1 and WHITE lead towards R231. Clip D206.

Expander- Remove C119. Install BLACK lead to positive side, WHITE lead towards RF C6.

PREAMP RECOMMENDED

MIDLAND 13-864

Compressor- Remove C32. Install BLACK lead towards R35 and WHITE lead towards R39.

Expander- Remove C33. Insert BLACK lead towards R38, and the WHITE lead towards R39.

NO PREAMP

SPECIFIC INSTALLATION INSTRUCTIONS (CONT)

FOR VSB-1

MIDLAND 79-893 -

Compressor- Remove D601 and D602. Solder BLACK wire to C603 and WHITE wire to C605.

Expander- Remove C92. Solder BLACK wire towards collector of TR17, and WHITE wire towards D29.

NO PREAMP

PEARCE-SIMPSON BENGAL SSB -

Compressor- Remove C189. Insert BLACK wire in positive side of hole towards R160, and the WHITE wire towards the MIKE GAIN CONTROL.

Expander- Remove C88. Insert BLACK wire to positive side and WHITE wire towards CB/PA switch.

NO PREAMP

PRESIDENT AR-14 -

Compressor- Remove C47. Solder BLACK wire to the common of TR9 and the WHITE wire to R27. Remove TR8.

Expander- Lift Brown wire at the volume control. Connect brown and BLACK wires together. Resolder WHITE wire to the volume control.

PREAMP RECOMMENDED

PRESIDENT AR-44 -

Compressor- Remove C89, and insert the BLACK lead to the input and the WHITE lead to the output of the vacated cap. (towards R53).

Expander- Remove C56, and solder the BLACK lead to the collector, and the WHITE lead towards R52. Remove TR14.

NO PREAMP

SPECIFIC INSTALLATION INSTRUCTIONS (CONT)
FOR VSB-1

DWIGHT D. 1003002 -

Compressor- Remove C127. Solder BLACK wire towards R102 and WHITE wire towards R57. Remove TR16.

Expander- Remove R32. Connect BLACK wire towards C32, and WHITE wire towards the volume control.

PREAMP RECOMMENDED

PRESIDENT ANDREW J. 1012001 -

Compressor- Remove C89. Solder BLACK wire towards C96 and WHITE wire towards R53. Remove TR14.

Expander- Remove C56. Solder BLACK wire towards the common of TR10 and the WHITE wire towards R52.

NO PREAMP

PRESIDENT GRANT/MADISON (1010002) with MB8719 chip -

Compressor- Remove C101. Solder BLACK wire towards collector of TR23, and the WHITE wire towards R118.

Expander- Obtain a 1N914 diode and 100K resistor. Remove C183. Connect BLACK wire towards the common of TR43 and the WHITE wire to the anode of the 1N914 diode. Connect a 100K resistor at this junction also. Solder cathode towards pin 8 of IC6.

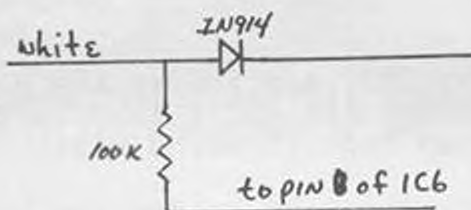

NO PREAMP

SPECIFIC INSTALLATION INSTRUCTIONS (CONT)

FOR VSB-1

PRESIDENT HONEST ABE -

- Compressor- Remove D13 and D12. Solder BLACK lead to where cathode of D13 was and the WHITE lead to where cathode of D12 was.
- Expander- Remove C29. Insert the BLACK lead towards R26, and the WHITE lead in the other hole.

PREAMP RECOMMENDED

PRESIDENT THOMAS J. 1013001 -

- Compressor- Remove C37. Solder the BLACK wire towards the common of TR17, and the WHITE wire towards R48. Remove TR18.
- Expander- Remove C33. Solder the BLACK wire towards D7, and the WHITE wire towards C34.

PREAMP RECOMMENDED

PRESIDENT WASHINGTON(1001002)/NEW McKINLEY -

- Compressor- Remove C83. Solder the BLACK wire to the positive side of the hole, and the WHITE wire to the other side, towards TR27. Remove TR32.
- Expander- Remove C110. Solder the BLACK wire towards the collector of TR36, and the WHITE wire towards pin 4 of IC4.

NO PREAMP

PRESIDENT VEEP 1014001 -

- Compressor- Remove C47. Solder the BLACK wire to hole by TR9, and the WHITE wire towards R27. Remove TR8.
- Expander- Lift the brown wire off the volume control. Connect brown and BLACK wires together. Solder the WHITE wire to volume control.

PREAMP RECOMMENDED

SPECIFIC INSTALLATION INSTRUCTIONS (CONT)

FOR VSB-1

ROBYN SB-540D -

Compressor- Remove C311 and C331. Insert BLACK lead towards R397 and the WHITE wire towards R322.

Expander- Remove C193. Insert the BLACK wire towards the common of Q19 and the WHITE wire towards R195.

NO PREAMP

SEARS ROADTALKER 40(934-3827) -

Compressor-

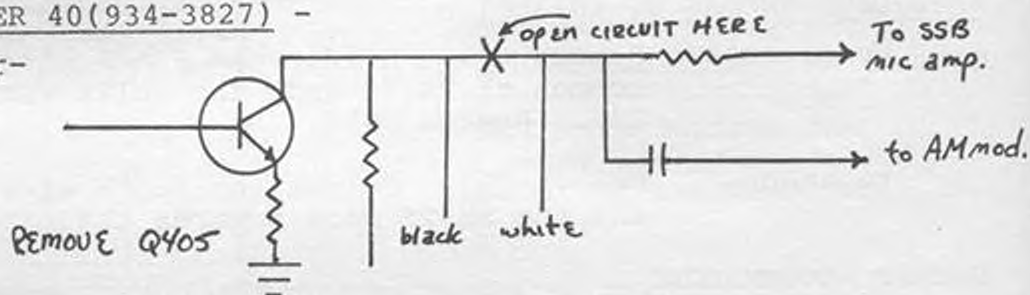

Expander- Insert at C263, the BLACK lead towards D257, and the WHITE lead towards P36.

PREAMP RECOMMENDED

SHARP CB - 2460 -

Compressor/Expander- This radio will require use of an additional 4PDT relay- wired as follows:

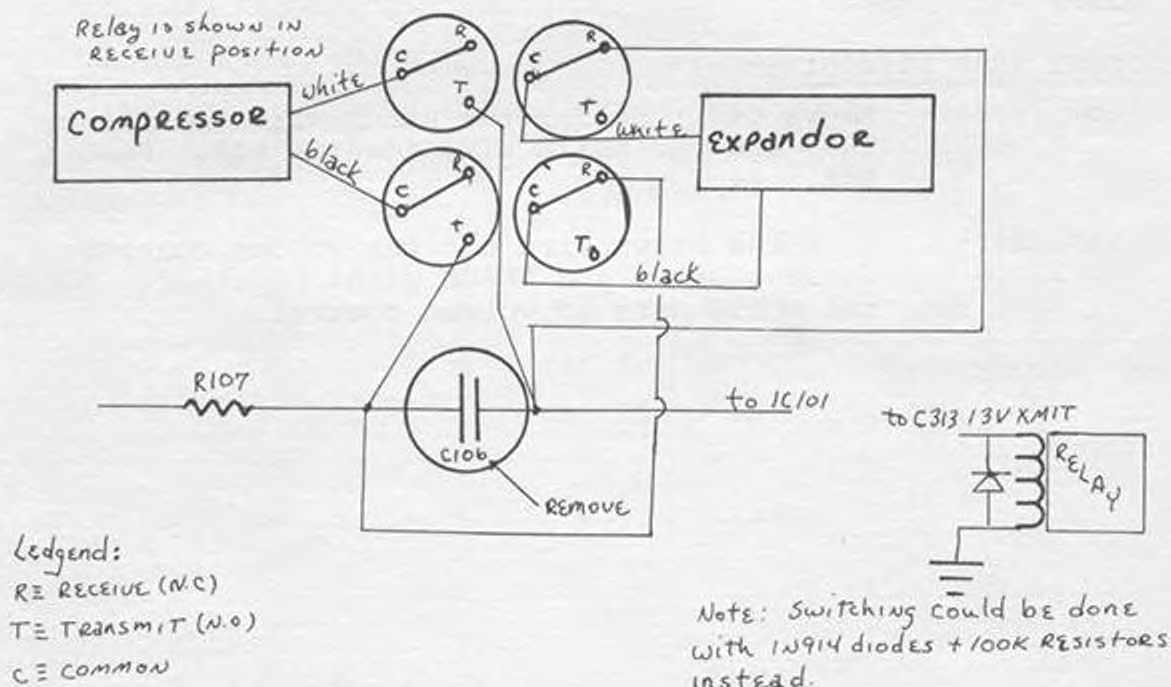

SPECIFIC INSTALLATION INSTRUCTIONS (CONT)

LEO'S C.B. SHOP
RT. 2, BOX 158-B
JASONVILLE, IN 47438
PH. 812-665-3837

FOR VSB-1

STANDARD HORIZON 29A -

- Compressor- Remove C305. Install the BLACK wire to the positive side of hole and the WHITE wire towards R251. Remove TR219.
- Expander- Remove C242. Install the BLACK wire into the positive side of the hole and the WHITE wire towards R250.

NO PREAMP

TEABERRY MIGHTY T-

- Compressor- Remove C711 and insert compressor leads in place of the capacitor, with the BLACK lead as the input and the WHITE lead as the output.
- Expander- Remove C503 and insert the expander leads in place of the capacitor, with the BLACK lead as the input and the WHITE lead as the output.

NO PREAMP

TRAM D42-

- Compressor- Remove C85. Solder the BLACK wire towards R89, and the WHITE wire towards R84. Clip CD11.
- Expander- Remove C39. Install pre-amp. Solder the BLACK wire to the output of pre-amp and the WHITE wire towards the volume control.

PREAMP REQUIRED

TRAM D201-

- Compressor- Remove C615. Solder the BLACK wire towards plate of V600. Solder the WHITE wire towards R626. Clip D605.
- Expander- Remove C432. Solder the BLACK wire towards C431 and the WHITE wire towards C619.

NO PREAMP

SPECIFIC INSTALLATION INSTRUCTIONS (CONT)

FOR VSB-1

COURIER GLADIATOR -

- Compressor- Remove C153. Solder the BLACK wire to the positive side of the hole and the WHITE wire to the other hole. Clip D47.
- Expander- Remove C166. Solder the BLACK wire to the positive side of the hole, and the WHITE wire to the other hole towards D56.

7.8MHZ ADJACENT CHANNEL FILTER

We have discontinued our "Super Ears MOD 3", Adjacent Channel Rejection (ACR) Filter for a Uniden 858 chassis SSB transceiver, but here is how to do it for anybody still wanting to improve ACR.

First, order the following parts from COBRA:

One (1)	L6	Part # 060-085-9-010	LA179 Coil
One (1)	FT2	143-006-9-002	7.8MHz Filter

After you receive the parts, remove the jumper wire between L5, and C20. The holes for the parts are there, they have just been left out. Solder FT2 in it's place, and solder L6 in it's place. Turn set ON, and adjust L6 for maximum output.

Some sets, like the 139XLR, already have this installed. Remove the cover from you Uniden 858 chassis radio and to make sure if this item is not already installed in your radio, before you order the parts!

HOW TO PUT YOUR YAESU FT707
ON 11 METERS



"WHAT A BEAUTY"

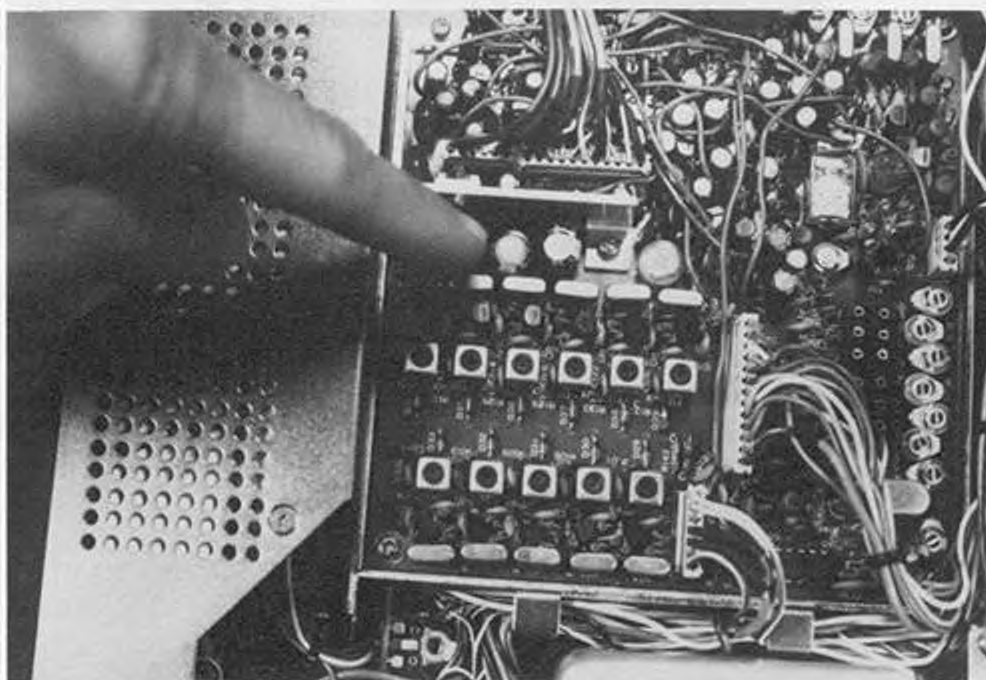

Crystal location AF Board

FT707 (CONT)

1. Remove X9 and X10 crystals, as shown in picture below.

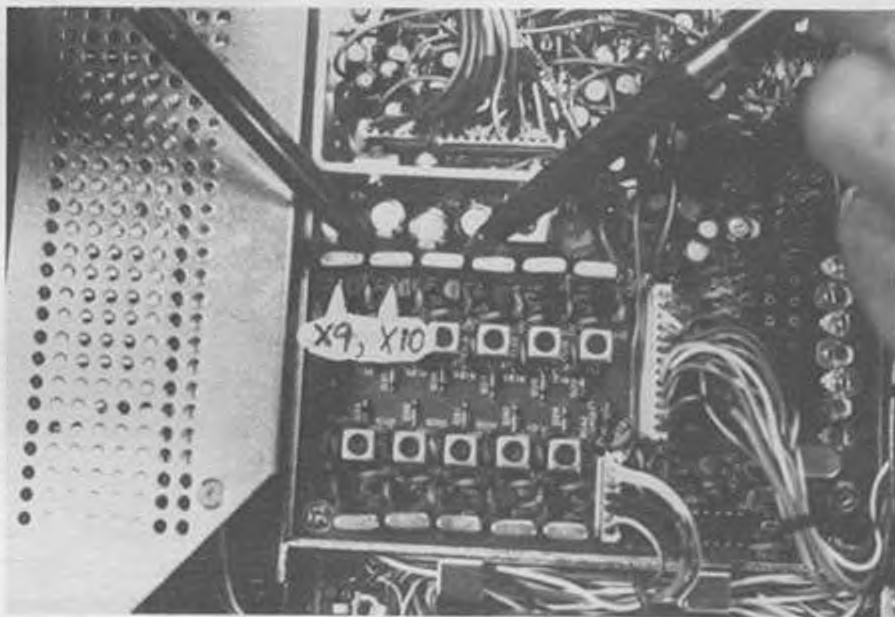

AF board

2. Replace with a 27 and 27.5 crystal, respectively. These are available from YAESU.

CRYSTAL SPECIFICATIONS

Holder	HC-25/U
Load Capacitance	30pf
Effective Resistance	25 ohm
Drive Level	5mW

FT707 (CONT)

3. Locate T40, and T41 coil (See picture below). Using an RF Wattmeter, peak T40, and T41, for maximum output.

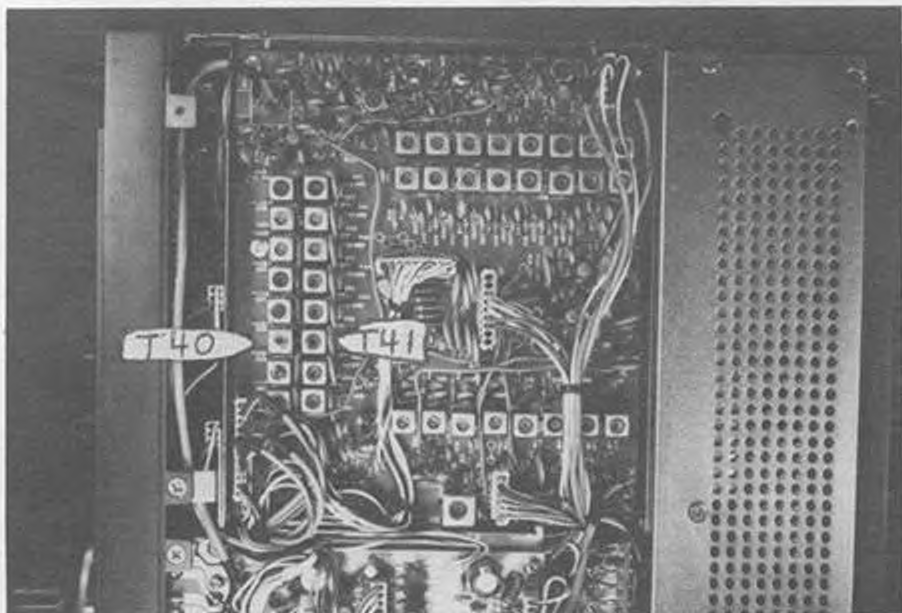

Rf board

4. Adjust T07 on 10A; T08 on 10B. Use RFVM at J06 #2 AF indicator, and peak for maximum reading (See picture below).

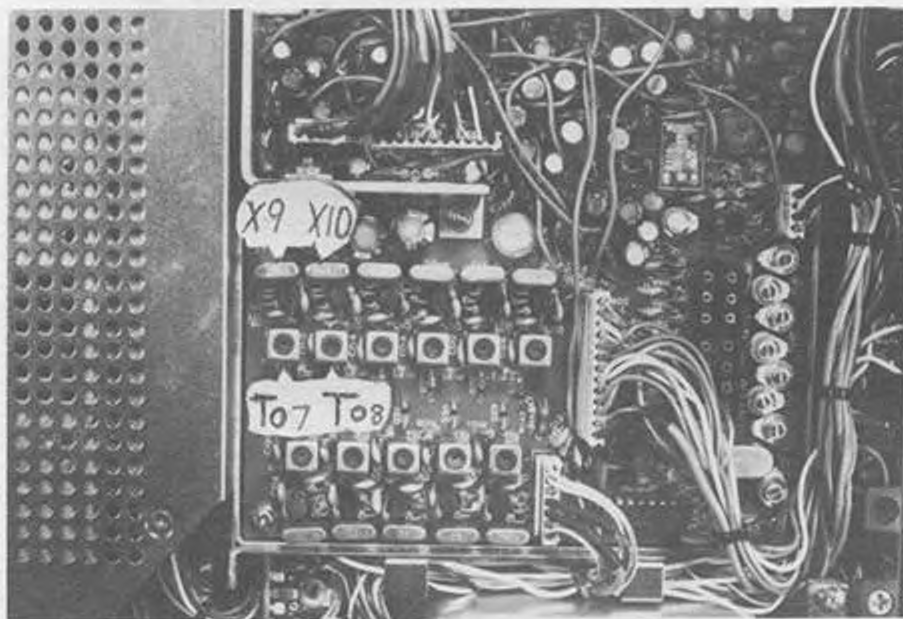

FT707 (CONT)

5. Adjust T08 for maximum output on RF Wattmeter.

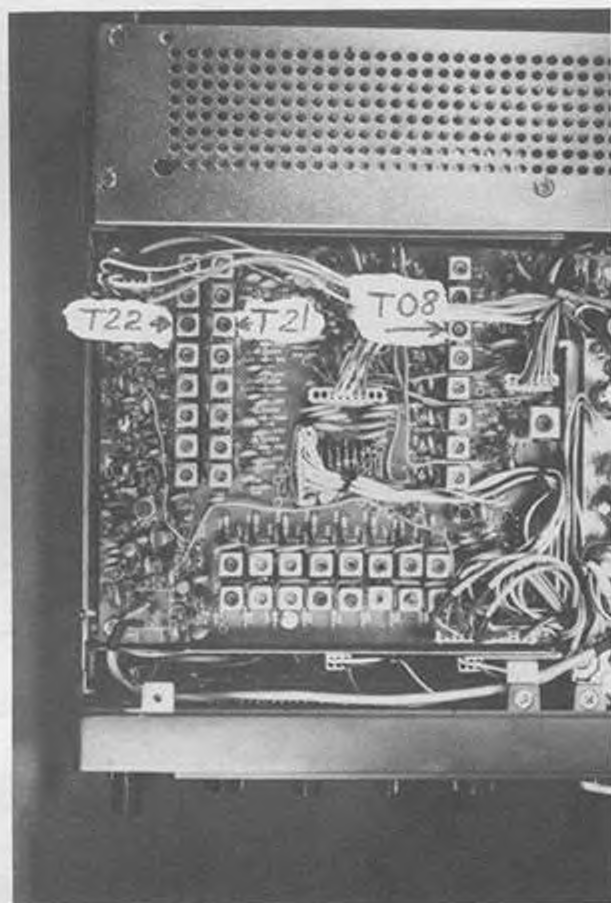

RF board

6. Adjust T21 and T22, for maximum output on RF Wattmeter on 10A and 10B respectively.

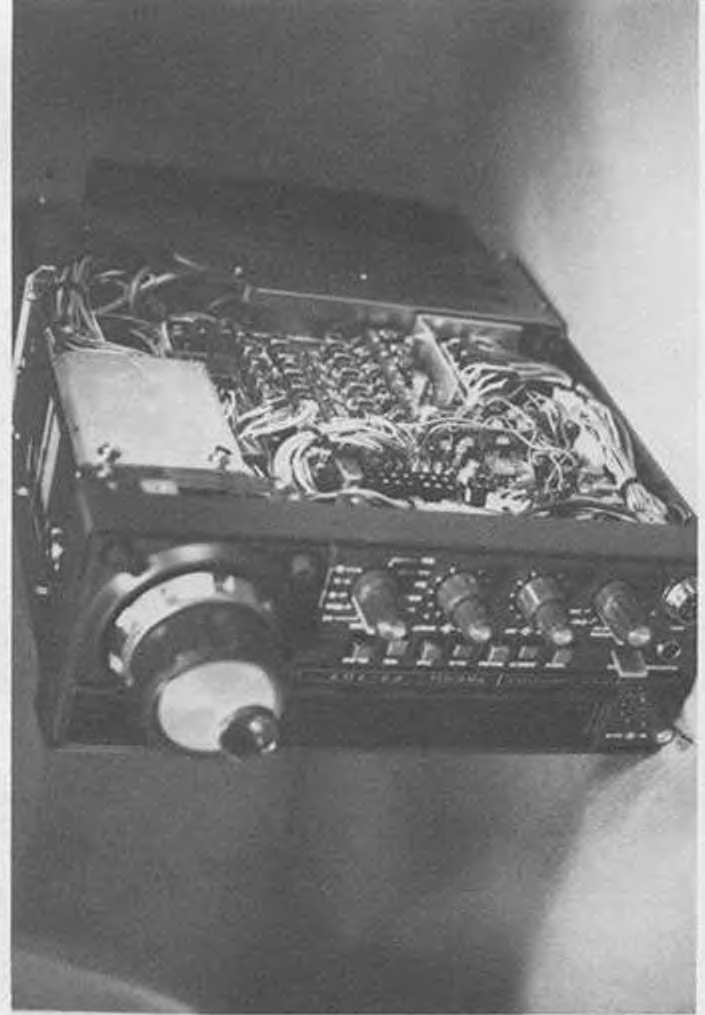
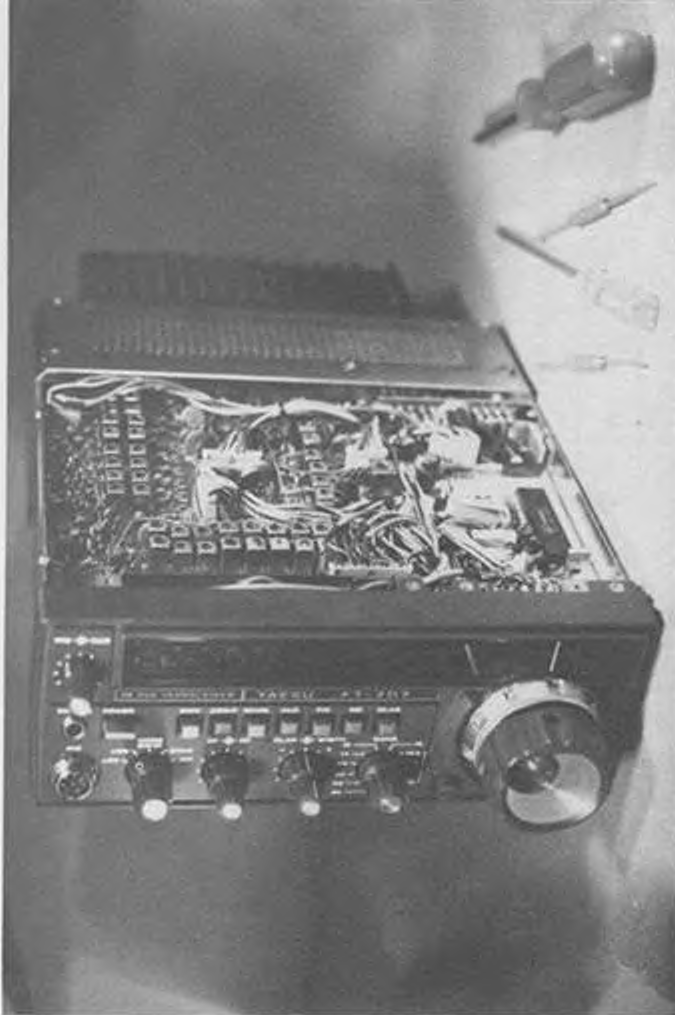

RF board; T08, T21, T22, T40, T41

AF board; X9, X10, T07, T08



Optional Antenna Tuner- A Real Jewel!

MB8719 STANDARD MODIFICATION

- 1) Insolate pin 10, if grounded.
- 2) Obtain two SPDT switches and connect commons of both switches to ground.
- 3) Connect one side of switch A to pin 10.
- 4) Connect one side of switch B to pin 11. You should now have 2 switches wired as follows:

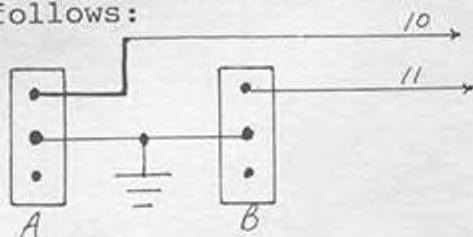

- 5) Adjust VCO (L13)

If your unit has an 11.3258 MHz crystal in it, you will now have frequencies from 26.815 to 28.045.

For frequency range with out misses, build this switch or order our kit number 13 (with crystal), or our number 14 (w/o crystal).

2P6 position switch

NOTE: This switch is a corrected issue of one shown on page 49, Volume 7.

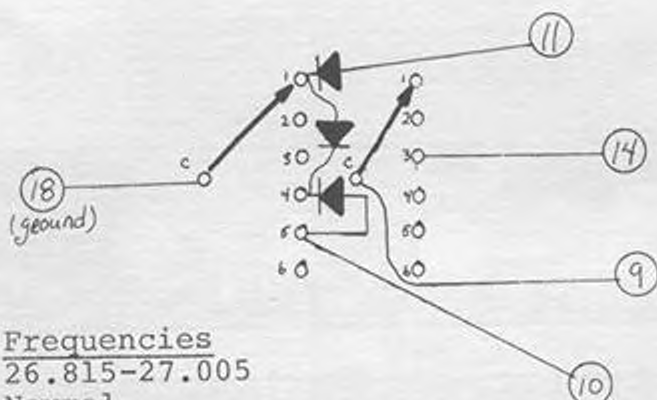

<u>POS</u>	<u>Frequencies</u>
1	26.815-27.005
2	Normal
3	27.415-27.445 (37, 38, 39, 40)
4	27.455-27.725
5	27.605-28.045
6	Normal

8719 FREQUENCIES WITH 11.3258

10 LOW

<u>CH</u>	<u>FREQ</u>		<u>CH</u>	<u>FREQ</u>
1	27.605		21	27.855
2	27.615		22	27.865
3	27.625		23	27.895
4	27.645	LEO'S C.B. SHOP	24	27.875
5	27.655	RT. 2, BOX 158-B	25	27.885
6	27.665	JASONVILLE, IN 47438	26	27.905
7	27.675	PH. 812-665-3837	27	27.915
8	27.695		28	27.925
9	27.705		29	27.935
10	27.715		30	27.945
11	27.725		31	27.955
12	27.745		32	27.965
13	27.755		33	27.975
14	27.765		34	27.985
15	27.775		35	27.995
16	27.795		36	28.005
17	27.805		37	28.015
18	27.815		38	28.025
19	27.825		39	28.035
20	27.845		40	28.045

10+11 LOW

15	27.455		28	27.605
16	27.475		29	27.615
17	27.485		30	27.625
18	27.495		31	27.635
19	27.505		32	27.645
20	27.525		33	27.655
21	27.535		34	27.665
22	27.545		35	27.675
23	27.575		36	27.685
24	27.555		37	27.695
25	27.565		38	27.705
26	27.585		39	27.715
27	27.595		40	27.725

11 LOW

15	26.815		24	26.915
16	26.835		25	26.925
17	26.845		26	26.945
18	26.855		27	26.955
19	26.865		28	26.965
20	26.855		29	26.975
21	26.895		30	26.985
22	26.905		31	26.995
23	26.935		32	27.005

MB8719 MASTER SLIDE CONVERSION

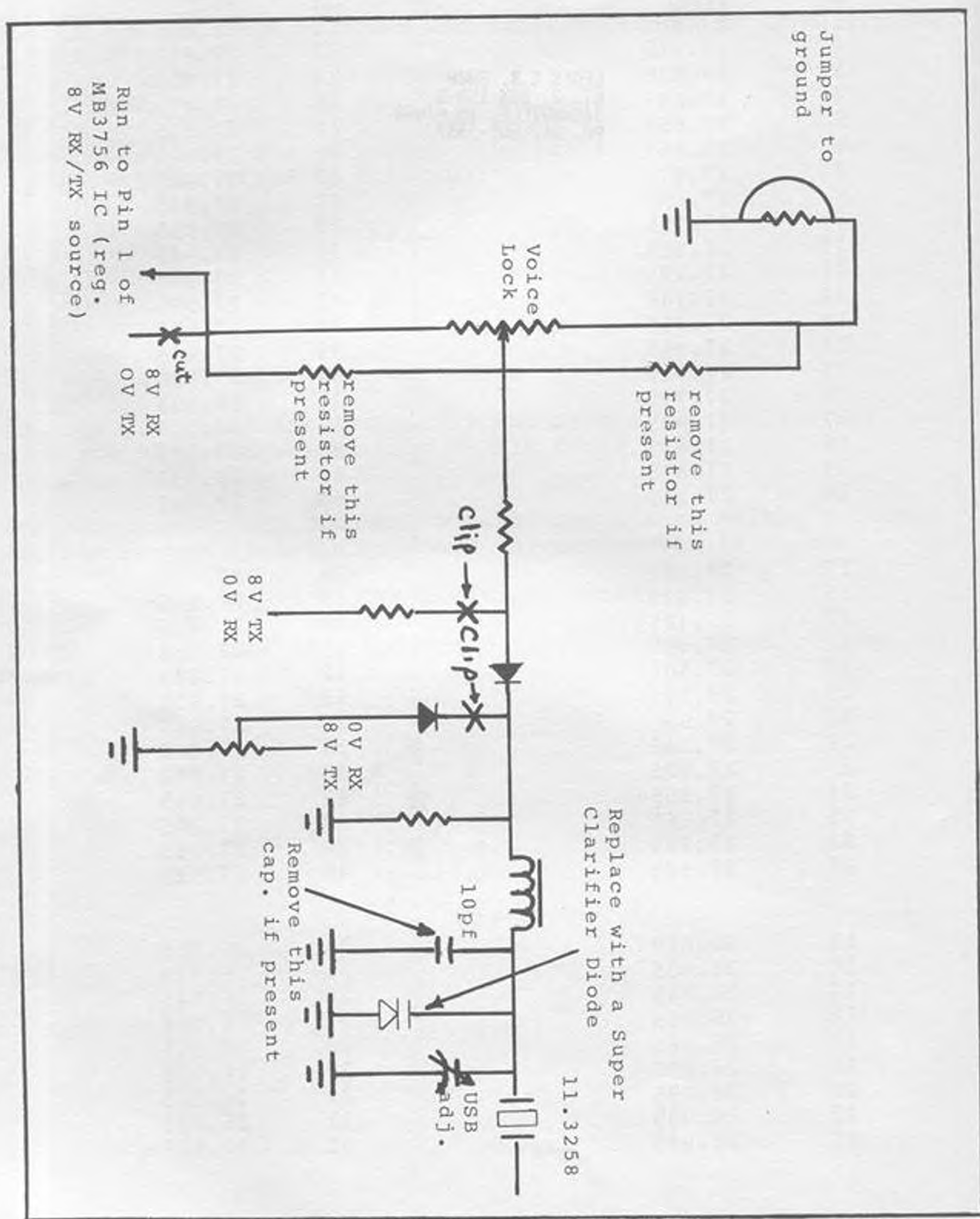

Expo Xtals. 11.259 High.
10.965 Low

PRESIDENT WASHINGTON MB8719 (11.1125)

COBRA 140GTL AND 142GTL

Clarifier-

1. Cut off the RED/WHITE wire on the end of the clarifier.

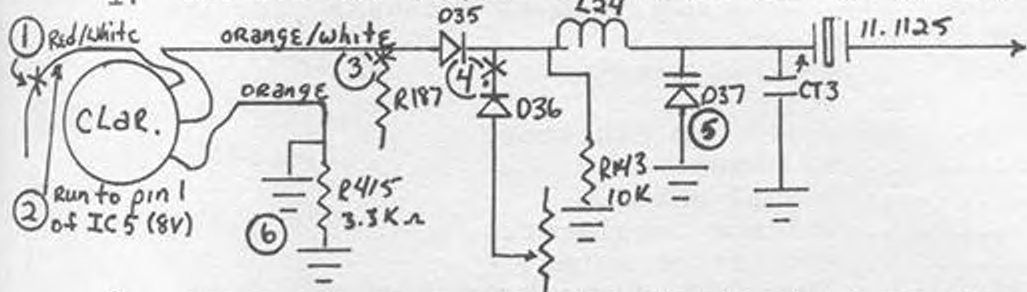

2. Run a new wire from the pot to pin 1 of IC5.
3. Clip R187.
4. Clip D36.
5. Replace D37 with a Super Clarifier Diode for more slide.
6. Ground the ORANGE wire.
L20 AM adjustment; L19 LSB; CT3 USB.

Channel Expansion-

1. Remove the 11.1125 Xtal (Note: if you want the LOW channel instead of the HI, skip steps one and two).
2. Solder in a 11.3258 Xtal.
3. Isolate pin 10 from ground.
4. Wire up two SPST switches as follows:

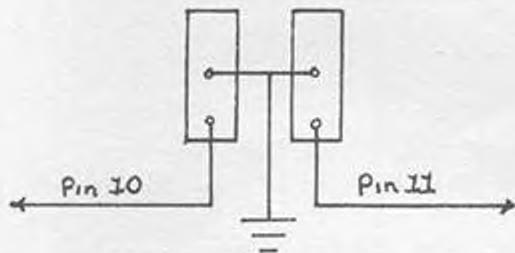

5. Refer to Standard Modification pages 25-27.

PRESIDENT WASHINGTON MB8719 (11.1125) (CONT)

L13 is VCO adjustment.
Readjust L26, L27, L28, L29, L36 as necessary for the
26.815-28.045 coverage.
Remove TR32.....AMC/ALC limiter.
Remove C81, near IC3.
Replace R84 with a 47K ohm resistor.
VR2.....SQ range.
VR1.....Signal meter.
RT301.....Voltage regulator.
VR12.....Modulation meter.
VR8.....35ma idle current for USB.
VR9.....45ma idle current for USB.
VR5.....Carrier balance.
VR10.....AM power.

PRESIDENT McKINLEY (1011001) 8719 w/11.1125

Channel Modification- use update in this volume, pages 25-27.

Clarifier-

1. Remove R415 and install a jumper in it's place.
2. Clip R187.
3. Clip D36.
4. Remove C132, if present.
5. For more slide, install a Super Clarifier Diode at D37.
6. Cut the ORANGE wire off of the Clarifier.
7. Run a new wire from the Clarifier to pin 1 of IC5, CT3, USB; L20 AM; L19 LSB. Widebanding: Remove C81; Change R84 to a 47K ohm resistor. Readjust VR5 for carrier null on SSB. Remove TR32 for maximum modulation. VR6 is for AM Power. The VCO is L13.

Channel Modification- Use the Update in this Volume,
pages 25-27.

Clarifier-

1. Clip R174
2. Clip D52
3. Clip the wire off of the clarifier that goes to R44.
4. Run a new wire from the Clarifier to Pin 1 of IC4.
5. Remove R175 and install a shorting jumper in it's place.
6. Remove C121, 10pf capacitor.

CTL, USB; L23, AM; L22, LSB.

Replace D35 with a Super Clarifier Diode for more slide.

Widebanding-

Remove C207. Change R206 to a 47K ohm resistor. Readjust VR4, for carrier null on SSB (if necessary). Remove TR24 for more modulation.

VR10, is AM Power.

VCO is L19.

TRAM D80 MB8734 w/11.3258

1. Remove MB8734
2. Replace with a MB8719 chip.
3. Wire up switch as shown in "Master MB8719 conversion", in this volume, pages 25-27.
4. Use slider conversion as found on "MB8719 Master Slider Conversion" pages 25-27.

REALISTIC TRC 450 (MB8734 CHIP)

Channel Expansion:

- 1) Change IC2 to an MB8719 PLL Chip.
- 2) Unground Pin 10 of IC2.
- 3) Wire the switches as follows:

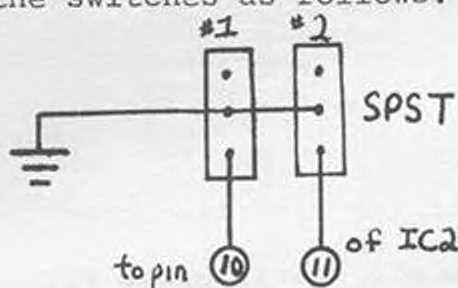

This will give channels from 26.815-28.045 in various combinations.

Widebanding Clarifier:

- 4) Remove C81
- 5) Change R84 to a 47K ohm 1/4 watt resistor.
- 6) Run GRAY wire on clarifier to pin 1 of IC5, to pick up 8V regulated source for Receive and Transmitt.
- 7) Ground BLACK wire on Clarifier.
- 8) Clip D36
- 9) Clip R187 (if there).
- 10) Adjust VCO L13, for coverage on all channels.
- 11) Replace D37 with a Super Clarifier Diode.
- 12) Adjust CT3, for USB; L19, LSB; L20, for AM.
- 13) VR6- AM Power.
- 14) AM Modulation - Clip D42 (near transformer).
- 15) VR7- SSB/ALC.
- 16) Readjust VRS for minimum carrier on LSB and USB with no modulation input (if steps 4 and 5 are carried out).

Refer also to pages 25-27.

REALISTIC TRC 459

1. Remove 9 screws in bottom cover and set aside.
2. Remove top cover
 - A. Remove 4 screws near each corner on sides
 - B. Remove 2 screws on center support
 - C. Remove clarifier, tone, RF gain, squelch, volume knobs
 - D. Lift off top.
 - E. Unplug speaker connector and plug in ext. speaker.
 - F. Unplug connector from keyboard to PC board.

Now we are ready to begin modification

3. Remove one screw on each side of front panel to swing up toward front (remove mike).
4. Unplug J101-PI connector toward front of IC1 on main board.
5. Very carefully, using an xacto knife with #11C blade cut away a small portion of the IC to expose Pin 9 (which has been clipped by manufacturer) and solder a wire onto it, using a grounded tip iron and applying as little heat as possible very quickly.
6. Connect another wire, to PI-1, (gray wire on J101)
7. Using a SPDT switch, connect as follows:

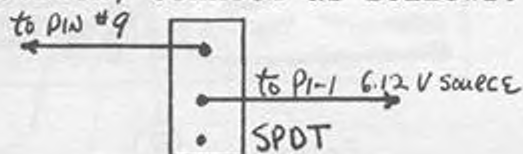

REALISTIC TRC 459 (Cont'd)

8. Wire another switch as follows-SPDT

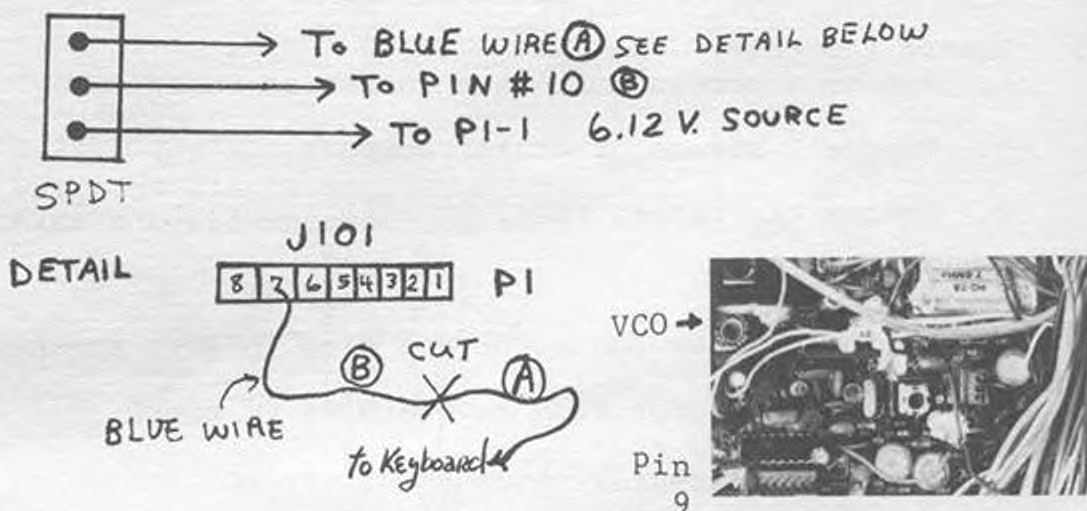

Note: Do the following steps if you want the channels on the NB/ANL and Dimmer switch:

1. Remove SWR CAL, NB/ANL, Dimmer knobs.
2. Remove 2 screws holding switch board in place.
3. Lift up board so it is accessible.

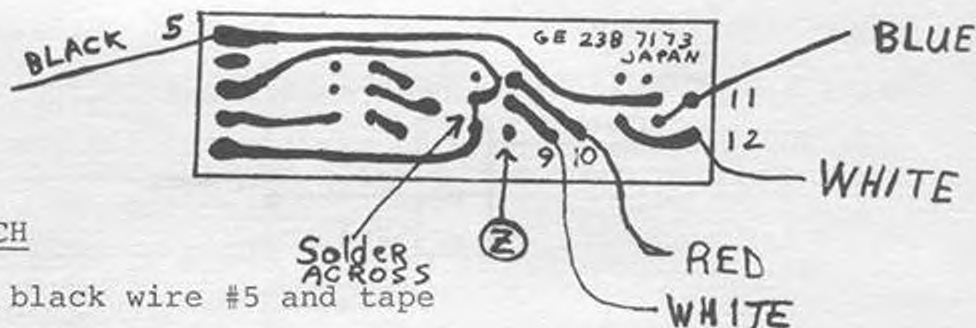

DIMMER SWITCH

- A. Cut black wire #5 and tape
- B. Cut blue wire #11 and tape
- C. Cut white wire #12 and tape
5. Solder a new wire onto where black wire was and connect other end to P1-1 to pick up 6.12V
6. Solder a new wire onto where blue #11 wire was and connect the other end to Pin #9 on IC1.

REALISTIC TRC 459 (Cont'd)

NB/ANL

7. Cut red #10 and white #9 and tape.
8. Solder across NB switch so #2,13 and 3, 14 are connected together. This is so NB will always be on.
9. Solder a wire from where white wire was (#9 hole) and other end to Pin #10, IC1 (blue wire, Step 8 page 1).
10. Solder a wire from where red wire was (10 hole) to end of blue wire (cut in Step 8 Page 1) encoder side.
11. Solder a wire to unused switch pole opposite #9 hole (marked # on above drawing) and connect other end to #5. Step 5 above to pick up 6 volt supply.
12. Reinstall board and knobs.

CHECKOUT AND ALIGNMENT

1. Double check all steps up to this point.
2. Plug in keyboard connector.
3. Apply power.
4. Adjust T1 VCO for full coverage.
5. For AM Mod. clip D54. This set does not have real good audio.
6. For ALC, clip R22. Sideband will run about 15-20W pep.
7. VR14 is AM power adjustment. It will bring it up to about 8-10W, but I suggest keeping it at 4-5W to get good modulation drive.

CLARIFIER MOD.

1. Cut wire off of J103-3 and ground (this is a violet wire)
2. Cut green wire off J103-1 and splice into gray wire next to R2 at point 35. This is a 6.12 volt source.
3. Clip R2.
4. Slide +3KC -2KC. Super diodes or chokes will not give you anymore slide in this design.
5. L2 adjusts USB; VR3 adjusts LSB; VR2 adjusts AM. Readjust as necessary to give proper up/down slide and proper USB/LSB offset.

REASSEMBLE, HOOK UP SPEAKER AGAIN AND YOU ARE READY TO GO.

This set, as is, will perform really well as a low frequency radio. However, with the stock 17.8875 crystal, it will only go up to 27.595. If you would like to change the output frequency, here is how to do it.

If we substitute a 17.215 crystal in place of 17.8875 crystal, channel 1 will drop down to 26.295, a drop of 670 KC. If you subtract the crystal frequency you can see that a change in X2 gives a corresponding change in output frequency of the same amount of KC difference between X2 and the new X2. For coverage up to 28.045, change X2 to a 18.3375 Xtal. Adjust T1 VCO adjustment for full coverage.

PLL INFORMATION

Any chassis which has the MB8734 PLL chip can easily be modified. Although it could be done by switching the 11MHz crystal, that leaves something to be desired. By far, the best way to do this is to pull the 8734 and replace it with the now famous MB8719 PLL chip. Then use the standard modification (pins 10 and 11) as found on pages 25-27 this volume. Check to make sure the unit in question has an 11.3258 Xtal or you will go down instead of up.

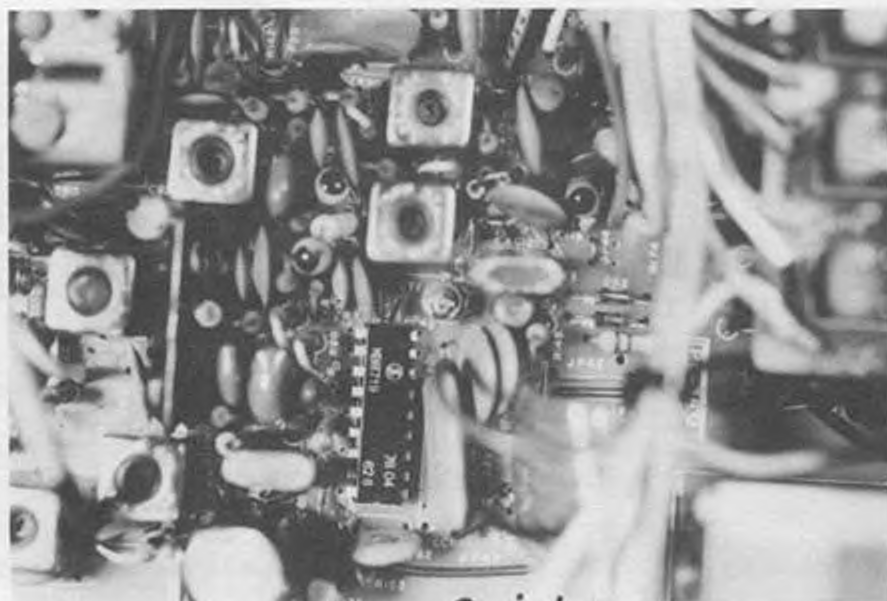

CLARIFIER

1. Clip D30.
2. Clip R117.
3. Lift end of R119 opposite D32-R119 junction.
4. Solder a wire onto this end and other end should go to the cathode of D44. See below.

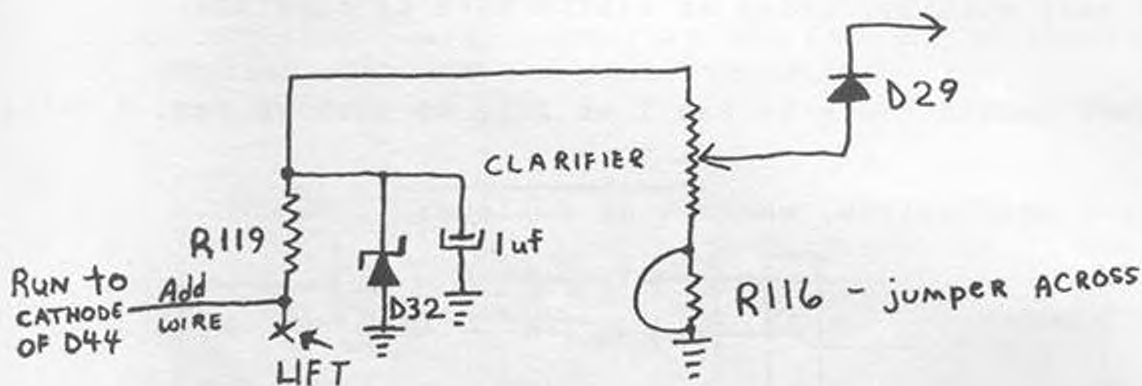

5. Change D32 to an 8.7 volt zener diode.
6. Change R162 to a 1K resistor.

FREQUENCY EXPANSION

1. Isolate pin 19 from ground, 858 PLL Chip.
2. Solder a 4.7K resistor from pin 19 to ground. (Use resistor removed in Step 6 above.)
3. Connect a toggle switch as follows:

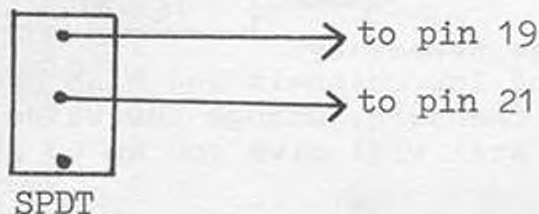

This will yield frequencies to 27.805. If you are interested in coverage from 26.085 thru 28.045, order our kit #20.

WIDEBANDING AND TUNE-UP

1. Locate L37 coil. Refer to 'The Art of Widebanding' In Volume 5, page 44.

VR8 Tx AM Power CT7 SSB ALC VR7 AM AMC VR12 PWR Meter

Adjust L39, L37, L32, L30 for maximum.

L27 is the TVI adjustment. RT301 adjusts AC power supply @ 13.8 volts.

REALISTIC TRC 480
(mobile Unit of TRC 459)

- 1) Locate IC1, LC7113 PLL chip. Very carefully, using an xacto knife with #11 C blade, cut away a small portion of the IC to expose Pin 9, (which has been clipped by manufacturer) and solder a wire onto it, using a grounded tip iron and very quickly, using as little heat as possible.
- 2) Connect another wire to Pin 1 of IC1, to pick up reg. 6 Volt.
- 3) Using a SPDT switch, connect as follows:

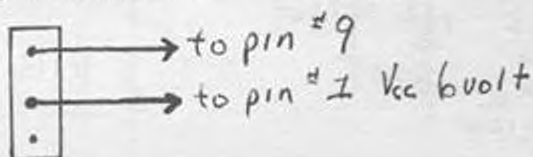

- 4) Locate P1/J301 BLUE wire. Cut BLUE wire in two and wire another SPDT switch as follows:

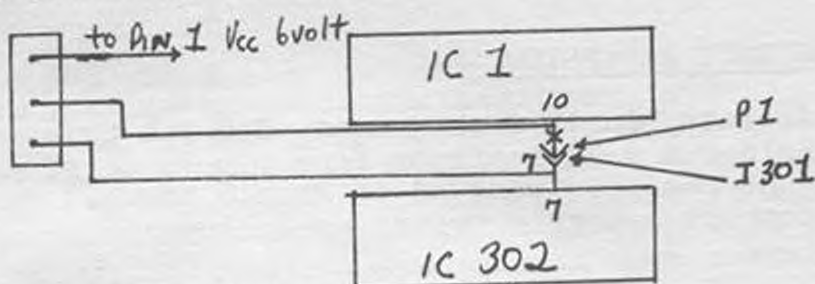

Adjust VCO, T1 as necessary.
This will give lots of low channels and high channels up to 27.595. For more up channels, change the value of X2. Changing X2 to an 18.2875 Xtal will give you up to 27.995 MHz.

Tune up:

Peak T3, T4, T5, L7, L10, L11. TC2 is TV1. VR6 is the driver bias. VR7 is the Final Bias. VR14 is the AM power. VR13 is the AM Modulation. VR11 is the Carrier Balance. VR4 is the SSB Modulation Gain. VR5 is the SSB Modulation Gain. VR8 is the RF Power meter.

Slider Info:

- 1) Cut BLUE wire off of PC board at R15 and ground.
- 2) Remove VR3 from board. Readjust VR1 and VR2 as necessary in relation with USB transmit frequency.

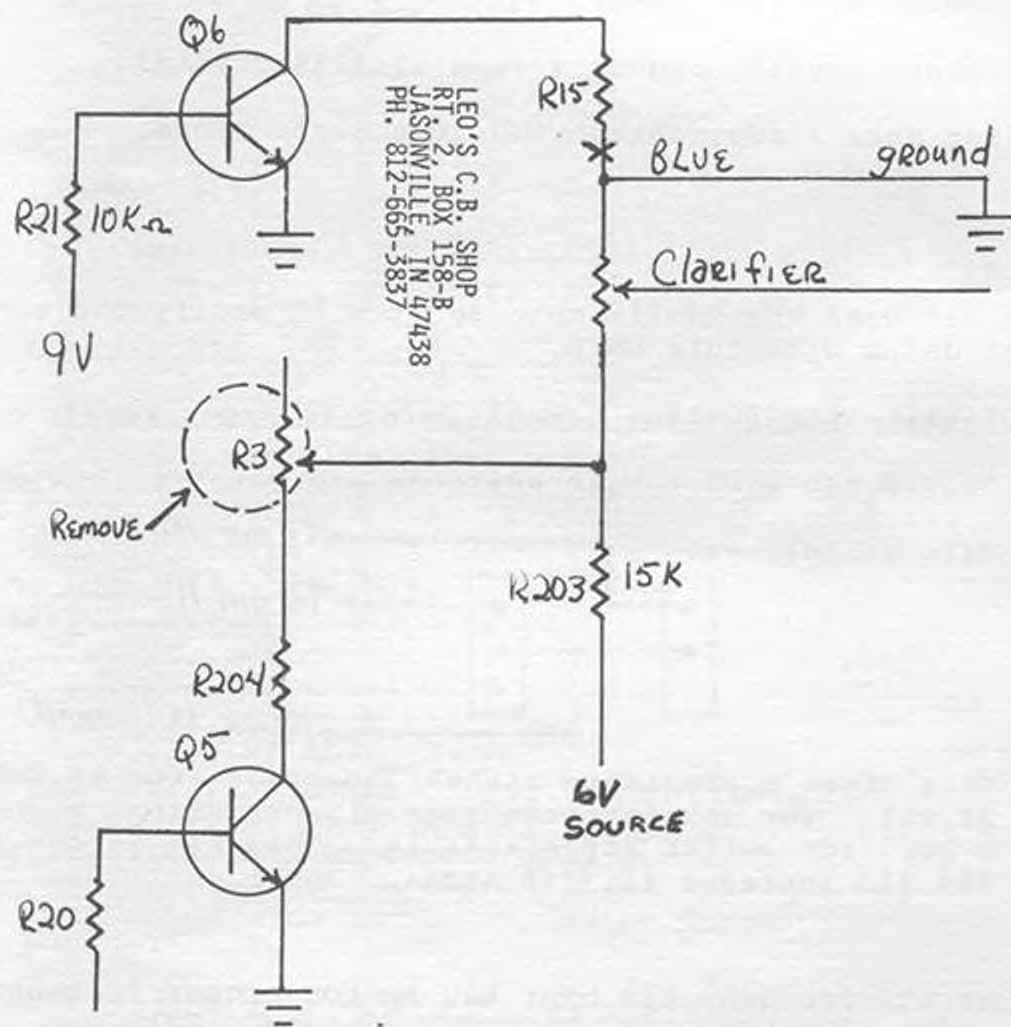

TEABERRY STALKER XV

Clarifier

1. Clip D36 and R187
2. Jump R415
3. Cut off RED/WHITE wire on clarifier, and tape. Solder a new wire from end of clarifier to pin 1 of IC5 for a stable 8V source.
4. Remove C132 (if used).
5. Change crystal number 4 to a 11.3258 crystal.
6. For more slide, change D37 to a Super Diode.

Frequencies

This set uses the MB8719 chip so it will modify the same as other units with this chip.

1. Isolate pin 10 from ground. Refer to pages 25-27.
2. Obtain two SPDT toggle switches and mount in bottom cover.
3. Wire as follows.

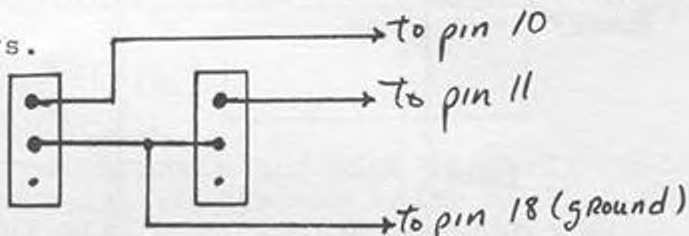

This gives approximate channel coverage from 26.815 to 28.045. For complete coverage without skips, we have a 6 position switch kit available. This kit is our #14, Kit #13 includes 11.3258 Xtal.

Tune-up

Adjust CT3 for USB; L19 LSB; L20 AM for proper frequency shift. Adj. L26, L27, L28, L29, L36, for maximum. VR12 mod. meter. VR8, RF driver bias; VR9 RF final bias; VR5 Carrier balance. VR7, RF ALC; VR6, AM Power; VR10 RF power meter.

Frequency Modification-

1. Remove the MB8734 chip
2. Replace with a MB8719 chip.
3. Unground pin 10.
4. Change X4 to 11.3258 Xtal.
5. Use conversion found on pages 25 to 27.

Clarifier-

1. Remove D36.
2. Cut ORANGE wire off of the clarifier control and tape. Run a new wire to pin 1, IC5
3. Clip R187.
4. Replace D37 with a Super Clarifier Diode. CT3, USB; L20, AM; L19, LSB.

Tune-up -

L13.....VCO
 Tune L26, L27, L28, L29, L36 on USB.
 VR12.....Modulation Meter.
 VR8.....RF driver bias (30ma idle current)
 VR9.....RF final bias (50ma idle current)
 VR5.....Carrier Balance.
 VR7.....RF ALC.
 VR6.....AM power.
 VR10.....RF power meter.
 VR11.....AMC(or remove TR32).

AR144/146GTL UPD 2824C PLL

For frequency modification from 26.515 to 27.855, use our kit #106. Chip can not be jumped. You must use a forced signal injector.

Adjustments-

VR6.....RF power SSB
VR10.....RF power AM
VR5.....AMC or clip collector of TR29

Clarifier (AR144)-

1. Locate the WHITE wire on the clarifier. Unsolder from PC board and resolder at the cathode of D50 to pick-up 8 Volt source.
2. Ground BROWN wire.
3. Clip D32.
4. Replace D30, with a Super Clarifier Diode.

The 146GTL has a PC board front. Simply make cuts on board to obtain this:

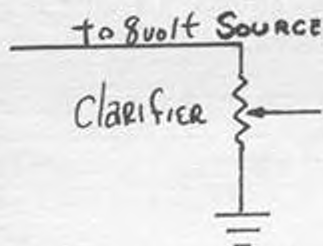

Tune-up -

Peak L40, L39, L38, L37, L27 on USB.

AR144 UPDATE

We have found that if you replace the UPD2824C with a UPD2816C chip, and disconnect pin 15, you can go up to 10 meter without any other changes. Ground pin 9 for 28MHz channels. Open pin 6 to take it high for higher 28MHz channels. Adjust L14. You can use the following switch box to re-program all 6 program inputs (pins 1-6).

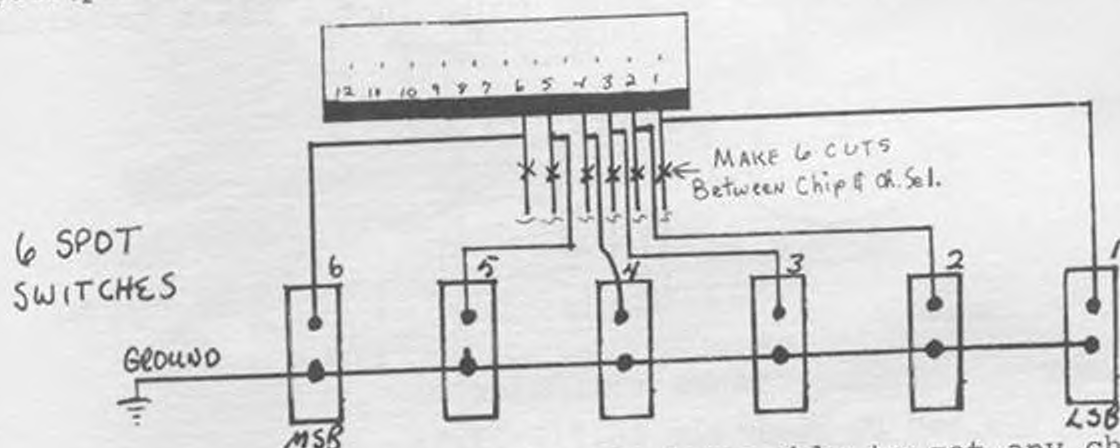

The only problem is that we haven't been able to get any channels between 27.405 and 28MHz!

PLL PINOUT DIAGRAM

UPD 2816C

Pin	1	Program input	P1
	2		P2
	3		P3
	4		P4'
	5		P5
	6		P6
	7	1/2T- F/F input	
	8	1/2T- F/F output	
	9	TX/RX switch input H-RX; L-TX	
	10	5.12MHz output	
	11	Power Supply Voltage	
	12	Crystal osc. output	
	13	Crystal osc. input	
	14	Buffered 10.24MHz output	
	15	Lock detector output (Xmit stop)	
	16	Lock detector integrator	
	17	Error signal output	
	18	Filter amplifier input	
	19	Filter amplifier output	
	20	Ref. freq. switch input H-10Kc; L-5Kc	
	21	Ground	
	22	Programmable divider input	



This chip is identical to the UPD 2824C, except that the latter does not have the pin 9 function.

COBRA 135XLR TC5080P UPDATE

5Kc Drop Switch:

1. Isolate pin 1.
2. Install a 100K ohm resistor from pin 1 to ground.
3. Add a SPST switch as shown to reconnect pin 1 and trace.

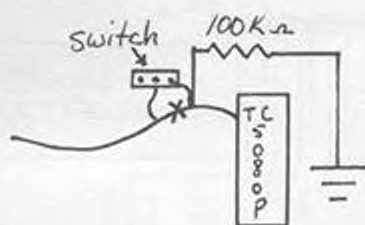

How to get LOW and HI channels 26.715-27.585

1. Cut pin 8 between resistor and channel select. (See fig. 1A).
2. Isolate pin 13. See fig. 1
3. Run a jumper from pin 13 to pin 16.
4. Wire up a SPST switch A as shown in fig. 1A.
5. Wire up a SPST switch B from pin 7 to pin 16, (fig. 1).

Retune T8, T9, T10, T11, T12, L5, L7, L3.
VCO coil is L301 LSB; L302 AM/USB
Replace CB301 with a Super Clarifier Diode.

Figure 1

Note: The wires that run from R372 to the individual board traces, should not be broken as in the illustration. To define the modification procedure the wires to the switches are shown on bare traces.

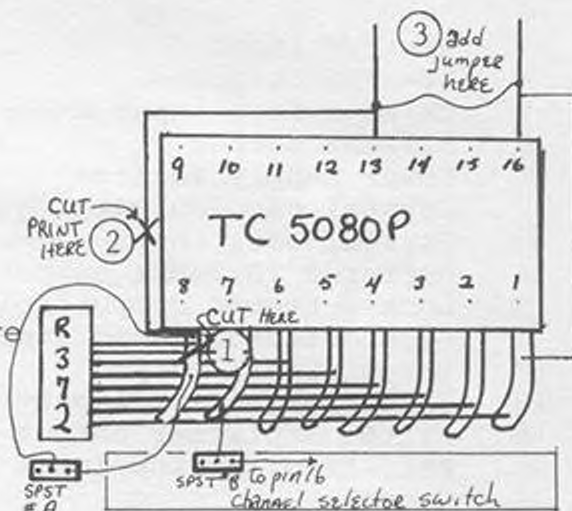

COBRA 135XLR TC5080P UPDATE (CONT)

Figure 1A

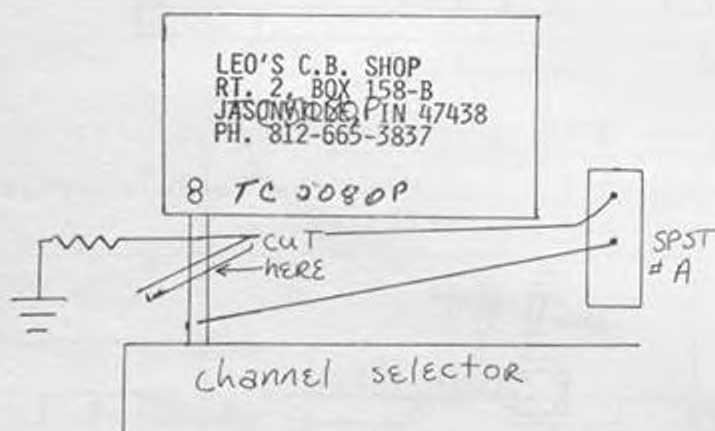

FREQUENCY CHART

CH.	LOW	HIGH - (Start on channel 12)	
7)	26.715	12)	27.425
8)	26.735	13)	27.435
9)	26.745	14)	27.445
10)	26.755	15)	27.455
11)	26.765	16)	27.475
12)	26.785	17)	27.485
13)	26.795	18)	27.495
14)	26.805	19)	27.505
15)	26.815	20)	27.525
16)	26.835	21)	27.535
17)	26.845	22)	27.545
18)	26.855	23)	27.575
19)	26.865	24)	27.555
20)	26.885	25)	27.565
21)	26.895	26)	27.585
22)	26.905		
23)	26.935		
24)	26.915		
25)	26.935		
26)	26.945		

TRAM D62, COBRA 132XLR, 135XLR, UPDATE

- 1) Locate Clarifier control R326 in Fig. 1. Cut conn. as shown

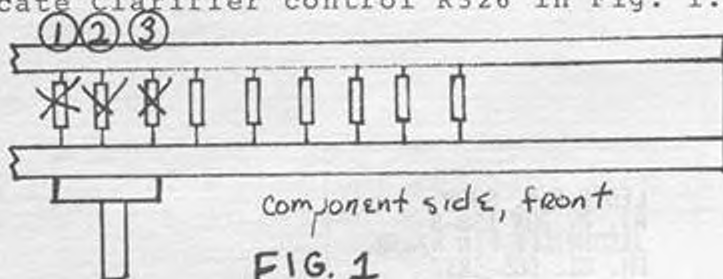

- 2) Remove end of R316 closest to the radio chassis side. (Long white wire at the end of R316)

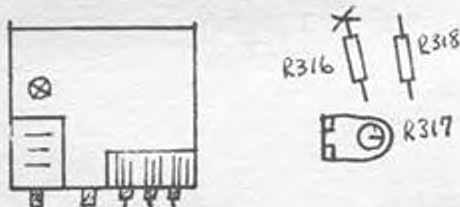

- 3) Solder a piece of wire to R316 and to centerpole of clarifier marked #2 in Fig. 1 above.

- 4) Remove end of R330 (shortest wire lead) from PC board.

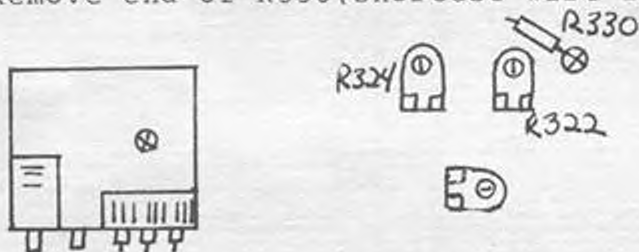

- 5) Solder another wire from short end of R330 to #3 post of clarifier in Fig. 1.

- 6) Solder another wire from solder connection (PC board side) at point 32 to post #1 on clarifier in Fig. 1.

TRAM D62, COBRA 132XLR, 135XLR, UPDATE (CONT)

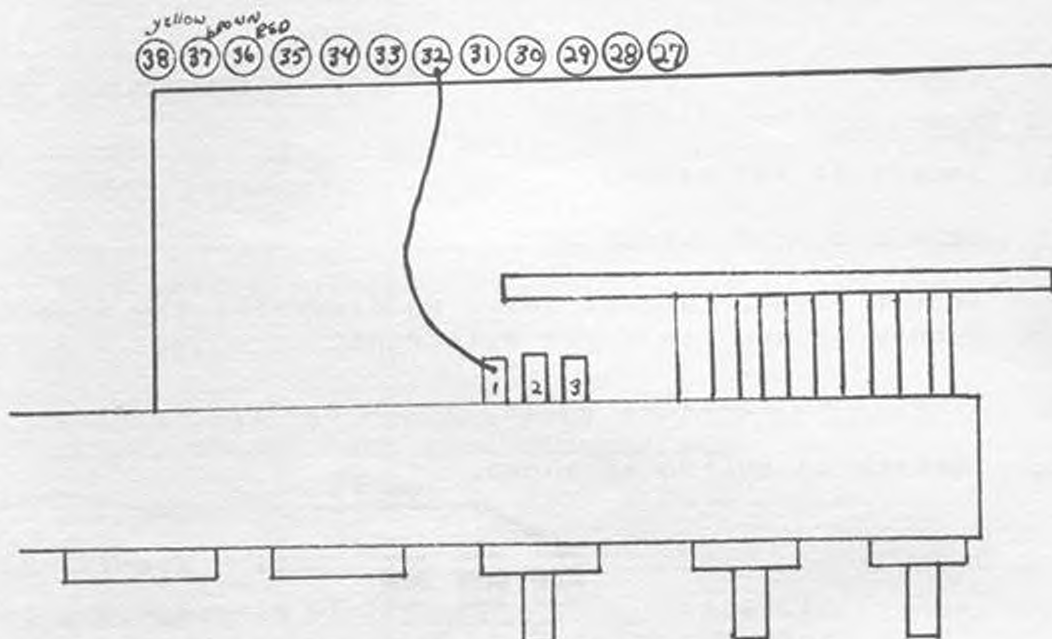

- 7) Adjust R317, R324, counterclockwise.
- 8) Unit now slides -15KC +3KC

MOTOROLA T4025A BASE PLL CHIP - 00S09

- 1) Cut foil around Pin 9 to isolate.
- 2) Obtain a SPDP switch and wire across cut on Pin 9 as below

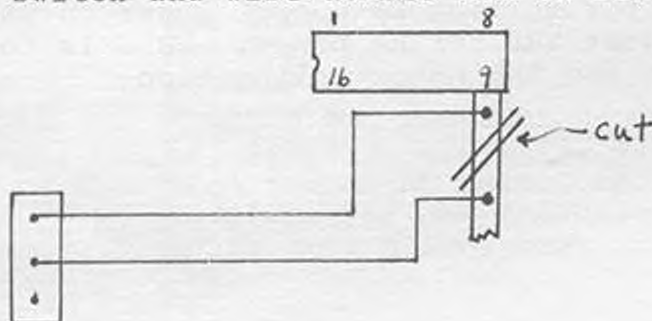

This will give channels 27.595 to 28.045

Channel Expansion-

1. Locate X4 and remove
2. Obtain a 3PDT switch
3. Inject signal into X4 holes to determine the Xtal frequency of new Xtals you will want.
4. Order the crystals.
5. Install on switch as shown.

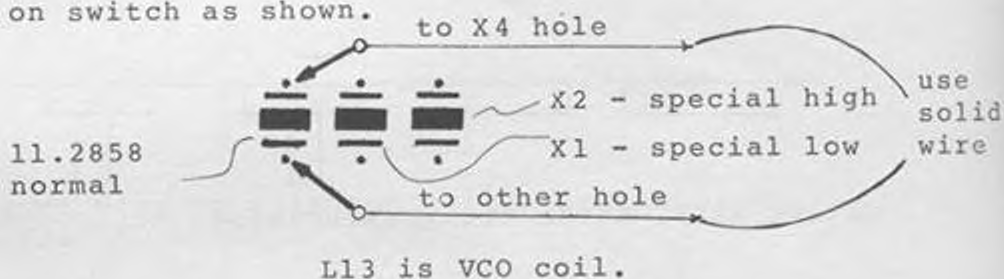

Clarifier-

1. Clip wires off of end of clarifier control.
2. Ground one end.
3. Run other end to pin 1 of IC5, MB3756.
4. Clip R142 (22K).
5. clip D55.
6. Change D54 to a Super Clarifier Diode.

CT3 USB; L20 AM; L19 LSB.

Adjust L26, L27, L28, L29, L36 on USB with a 2-tone input.
 Adjust VR7 for maximum RF output power on SSB. Repeak L36 on AM. Adjust VR6 for AM power. VR10 is for meter power. VR12 is for the SWR Meter calibration.

G.E. SUPERBASE 3-5875A

Clarifier modification -

1. Locate the clarifier control and solder a wire on the unused terminal.
2. Connect other end of wire to emitter of Q216 for a 9 Volt source voltage.
3. Clip R221.
4. Remove D204 and replace with a piece of wire. For more slide, change D203 to a Super Diode.
5. Clip R205

Channel Conversions - HI frequency

Use a DPDT center off switch and wire as follows:

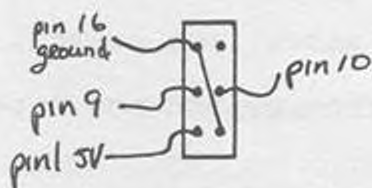

Cut the traces at pins 9 and 10 and solder a 1K ohm resistor across each trace. Adjust VCO as necessary to obtain all frequencies. For LOW and HI channels build a 6 position switch as shown on page 13 Volume 3.

Power Adjustments-

RV9 AMC or remove C71
VR10 Mod Meter
RV7 AV Sq. range
RV8 SSB Sq. range
RV1, RV2 Carrier bal.
RV3 SSB Mod. gain
RV201 SSB ALC
RV203 AWI
RV205 SWR meter

RV206 XMTR final bias
RV1 speech compressor
RV202 RF meter
RV10 RF gain range
RV6 SSB AGC receiver
Adjust T204, T205, T3, T209, L209, L212
L214 for mx RF output and broadband
coverage for new channels
RV207 XMTR driver bias

Channel expansion using NB and PA/CB switches. Below is a drawing of how the original switches should look, viewed with component side of chassis up.

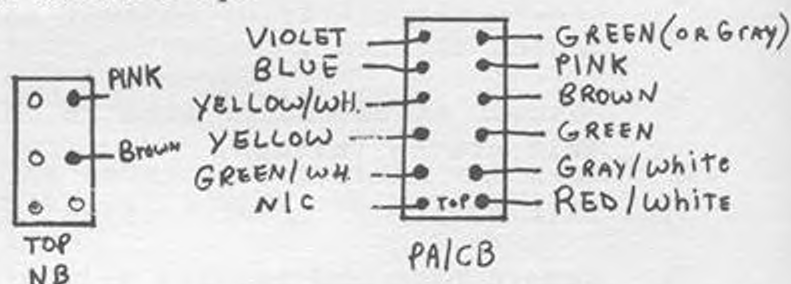

NB: Remove PINK and BROWN wires from switch, solder together and tape.

PA/CB: Remove VIOLET and BLUE wires from switch, solder together and tape.
Remove YELLOW and GREEN/WHITE wires from switch, solder together and tape.
Remove GREEN and PINK wires from switch, solder together and tape.
Remove GREEN and GRAY/WHITE wires from switch, solder together and tape.
Remove all remaining wires from switch and tape individually.

Below is a diagram of the CHANNEL SELECTOR SWITCH. Locate and unsolder 3 wires, BLUE, GREEN, AND VIOLET. Remove from radio.

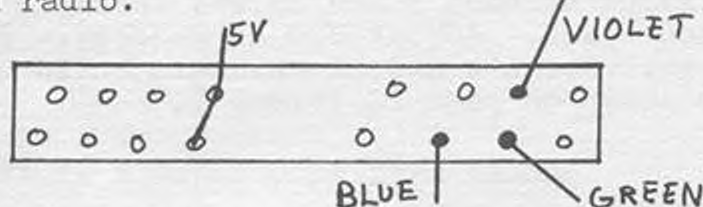

Wire switches and selector as in drawing below:

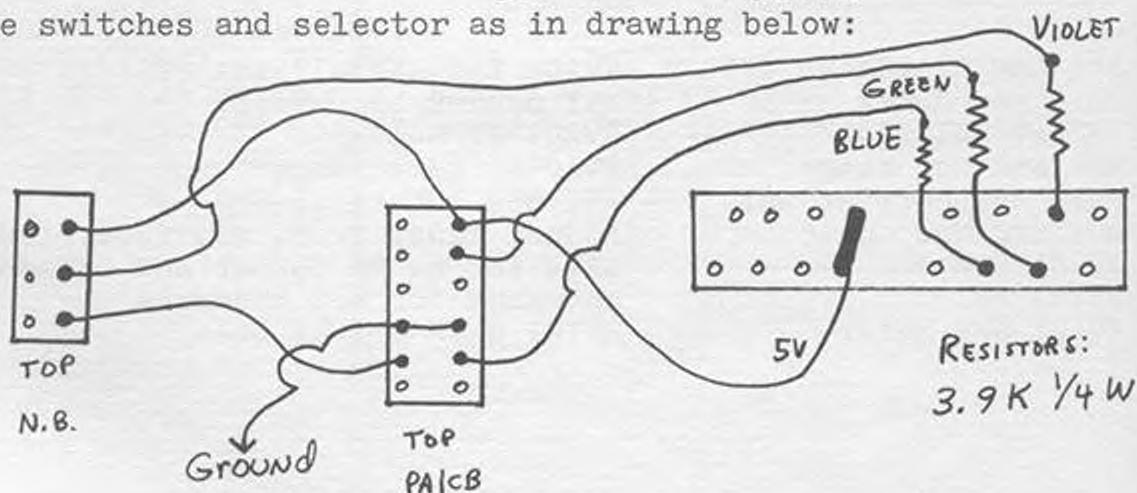

4730 con"t. Slider Info.

1. Locate BLUE wire that goes from the center of the FINE TUNE control over to the relay on PC board. Lift this wire at relay end.
2. Locate the junction of L2-R107. Resolder BLUE wire to that point.
3. Remove R104 variable resistor.
4. Retune L5 and L6 for center frequency.

HOW TO BROADBAND THE VCO AND XMTR COILS:

Locate T406 VCO Output transformer and modify pc board as per drawing.

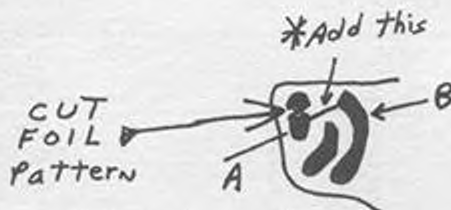

*SHORT POINTS A & B together

Locate T701 and modify as per drawing.

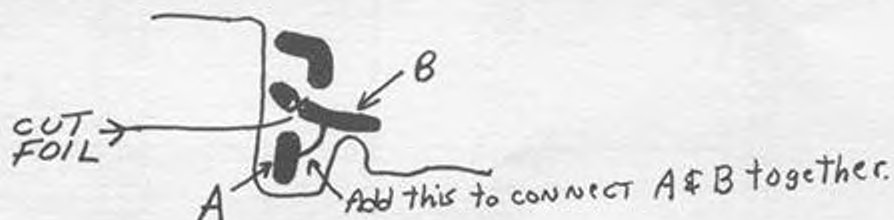

Peak out and adjust as necessary for frequency coverage the following coils: T406, T701, T702, C746, T703, T704, T705, & T706. C738 is the TVI adjustment. R725 is SSB ALC; R207 is AMC; R727 RF Meter.

You will have to retune the PLL (T1, L3, L4) and T406 & T701 for complete coverage.

JOHNSON Model 4730 Frequency Chart follows:

CH.	PA/CB UP;NB DOWN;	PA/CB UP;NB UP;	PA/CB DOWN;NB UP;
01	27.605	26.965	26.965
02	.615	.975	.975
03	.625	.985	.985
04	.485	.845	27.005
05	.495	.855	.015
06	.505	.865	.025
07	.515	.875	.035
08	.535	.895	.055
09	.545	.905	.065
10	.555	.915	.075
11	.565	.925	.085
12	.585	.945	.105
13	.595	.955	.115
14	.605	.965	.125
15	.615	.975	.135
16	.635	.995	.155
17	.485	.845	26.525
18	.495	.855	.535
19	.505	.865	.545
20	.525	.885	.565
21	.535	.895	.575
22	.545	.905	.585
23	.575	.935	.615
24	.555	.915	.595
25	.565	.925	.605
26	.585	.945	.625
27	.595	.955	.635
28	.605	.965	.645
29	.615	.975	.655
30	.625	.985	.665
31	.635	.995	.675
32	.485	.845	.685
33	.495	.855	.695
34	.505	.865	.705
35	.515	.875	.715
36	.525	.885	.725
37	.535	.895	.735
38	.545	.905	.745
39	.555	.915	.755
40	.565	.925	.765

CLARIFIER MODIFICATION SEARS 934.38260700

1. Locate HP2-3 connector. Cut the wire that goes over to one end of the Fine Tune control. Resolder this wire to pin 3 of IC502 voltage regulator so the fine tune control is fed with a steady 8 volt source.
2. Connect the other end of the Fine tune control to ground by shorting out R711.
3. Cut one end of R702 loose.
4. Replace D702 with a Super Clarifier Diode for more slide.

For frequency expansion, use the standard SM5104G mod. as in Volume 6, pages 26 & 27 for this set.

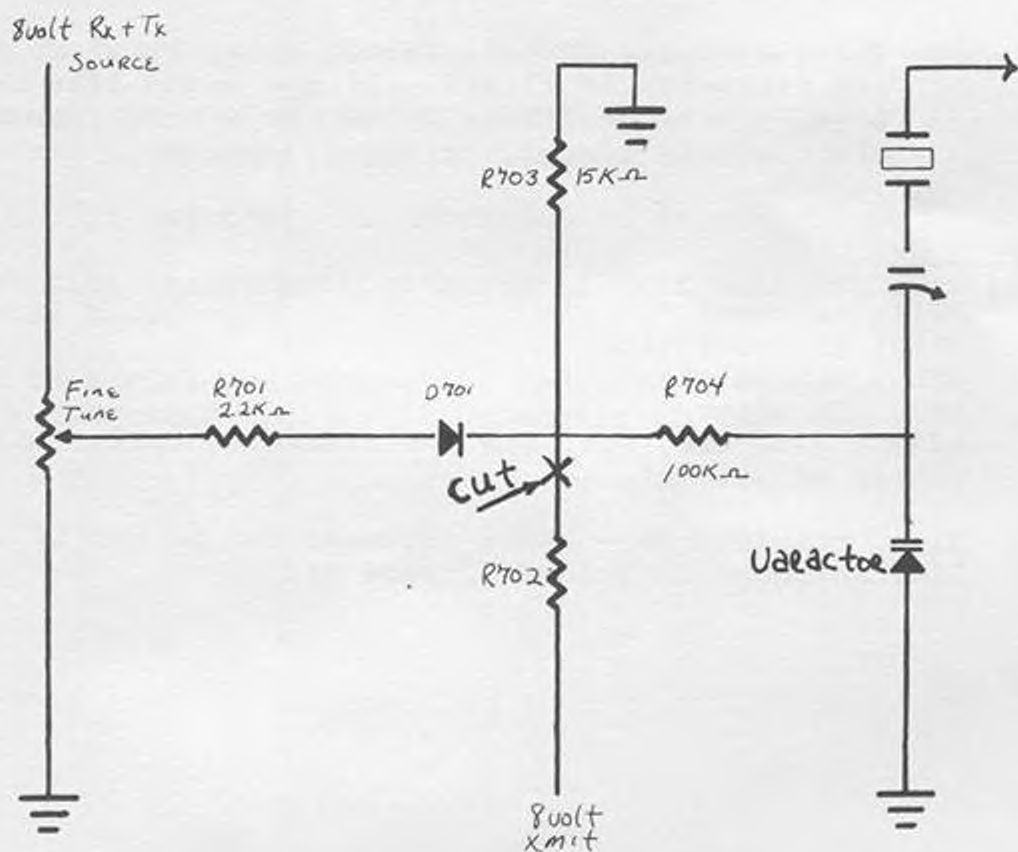

COURIER CENTURION 40D

Clarifier

1. Clip D39
2. Lift R115 oposite cathode of D36
3. Run a wire from free end of R115 to cathode of D48, 9Volt source. This will supply the clarifier with a steady voltage.
4. For more slide, change D1, D2, to Super Diodes (item number 28).

Frequency expansion

1. Remove pin 19 from ground by cutting trace
2. Solder a 4.7K ohm resistor from pin 19 to ground.
3. Using a toggle switch, switch pins 19 and 21 together for frequency to 27.805. If you would like coverage from 26 through 28MHz, order our kit #20, or build as diagramed in updated 858 info, page 74.

Tune - Up

RT14 AM power

RT601 AM modulation

RT8 SSB Balance

CT3 TX meter

Adjust L26, L24, L19, L15 for maximum output. L12 is TV1 filter adjustment.

Also, complete 26 - 28MHz coverage can be had by widebanding L24, as shown in Volume 5, page 44.

TRAM D201A UPDATE

1. Disregard information in Volume 3 page 22 of Secret CB. The following is an update for page 22. Page 23 of Volume 3 can be used for low frequency conversion and AM power increase.
2. Adjust R647 for AM modulation. Adjust R719 for max SSB output. Change R643 to 500 ohms 10 watts for 6-8 watt AM output. Install switch to short R642 for 15-20 watts. AM output or use information in Volume 3 Page 23.
3. High frequencies to 28 Mhz and clarifier unlocking:
 - A. Cut D125, D126
 - B. Connect terminal 10 on S4 to ground.
 - C. Cut white/blue wire from terminal 2 on S4.
 - D. Cut violet wire from terminal 3 on S4.
 - E. Jump terminals 1 and 6 on S4.
 - F. Adjust R145 on synthesizer board for max clarifier range.
 - G. Use manual tune with channel selector on channel 40 for high freq's, channel 1 for low freq's.
 - H. Adjust C319 and L301 for operation to 28 Mhz.
 - I. Adjust T101 on synthesizer board if unit will not oscillate up to 28 Mhz.

Note: Manual tune will not accurately indicate frequencies any more, a frequency counter is necessary to know where you are.

TECH TIPS

MORE ON THE 858 CHASSIS:

Seems like everytime I read the mail we have a few more letters on various 858 modifications a little bit different than previous ones. This chassis is truly a diehard and it looks like alot of experimenters are still playing with this one. So, following is a collection of more goodies for you all to try and enjoy!

Channel coverage from 27.415 to 28.045 with 2 switches:

Lift pin 19 from pc ground and solder a 4700 ohm resistor across cut. Using a SPDT Center off switch, connect pin 21 to center pole and pin 19 to one of the outerpoles. Channel 8 becomes 27.455 to channel 40 27.805. Now connect pin 18 to the outer pole remaining. In this position, channel 21,22,24,&25 become 27.415-27.445. Using a second SPDT switch, connect pin 21 to center pole, pin 18 to outerpole, and pin 20 to the other pole. The different combinations will give all channels from 27.415 to 28.045.

10 to 12 KC Slider with individual adjustment:

Remove CT-5 from the circuit and lift the grounded end (anode) of D43 and connect a Miller 4203-4205 3-8micro-henry choke in series with the anode lead to ground. Adjust the choke for 10-12 kc down and 2-4 kc up. This is for LSB only. For USB use CT4 and D41. For AM, use CT6 and D45 as above. This will give you a method to readjust your corelations on your crystals.

The following will help correct the problem of "dumping" alot of slide onto a very small portion of the control. An example of dumping is when you put the three Super Diodes in place of the stock varactors. There is a very simple cure. Simply remove the stock 20k Clarifier control and replace with a 5k control. This will give a relatively smooth 6kc down and 2kc up slide.

Want to INCREASE your modulation audio? Here is a simple mod: remove Diodes D21 & D22 and install a jumper wire between the two cathodes (banded end).

SEARS 562.38220700; TRAM D12

Low Frequency Conversion

5 KC step switch

1. Unground pin 1 of IC10.
2. Install a 100K ohm resistor from pin 1 to ground.
3. Obtain a SPST switch. Connect one end to pin 1, and the other end to pin 16.
4. Cut and isolate pin 13. Tie to pin 16.
5. Cut the trace on pin 8, between channel selector and res.
6. Cut trace on pin 7 between the channel sel. and res.
7. Cut trace on pin 6 between channel sel. and res.
8. Install a SPST switch across cut on pin 8.
9. Install a DPDT center-off as shown in fig. 1 on pin 7.
10. Install a DPDT center-off as shown in fig. 1 on pin 6.

Adjust VCO coils, L12 RX, L11 TMIT.

Tune T6, L5, L6, L3, for maximum.

R61 is AMC control, or remove Q13.

R4 is RF panel meter; R37 is SQ range; R17 is S meter.

For 26.515 - 26.955, replace X3 with 11.050, and X2 with 12.9325.

For 27.415 - 27.855, replace X3 with 10.600, and X2 with 13.3825.

Install X3 and X2 on switches.

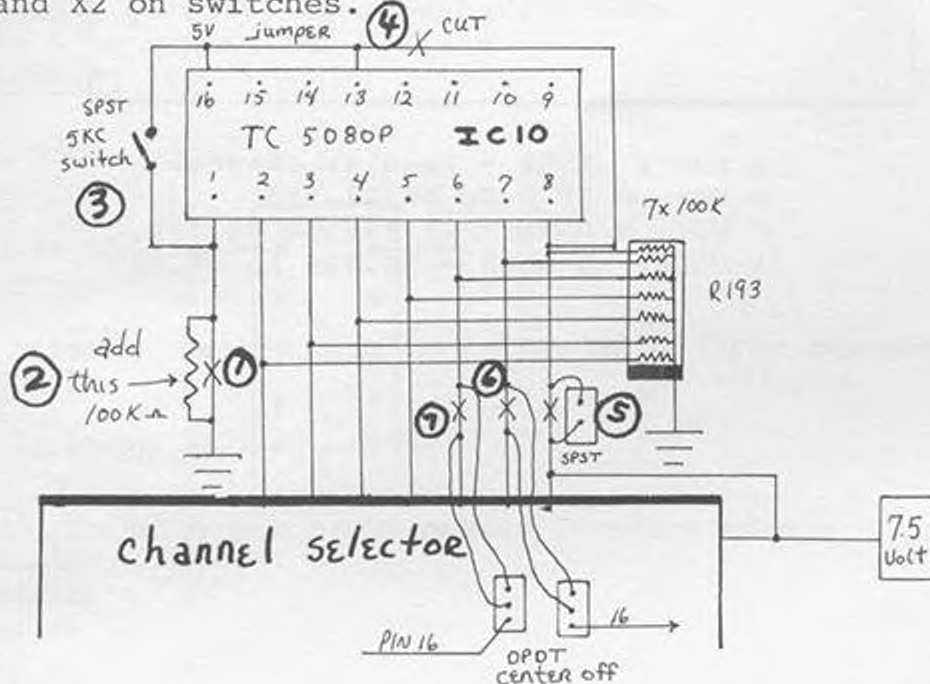

PANASONIC RJ3600

- 1) Locate UPD861 IC PLL chip, Pin 7.
- 2) Obtain two SPDT switches.
- 3) Solder a wire from Pin 7 to one side of switch A
- 4) Jump the center posts together and run a wire to TM3
- 5) Connect one end of switch "B" to where D25 was. (D21, 22, 24, 25, are removed).

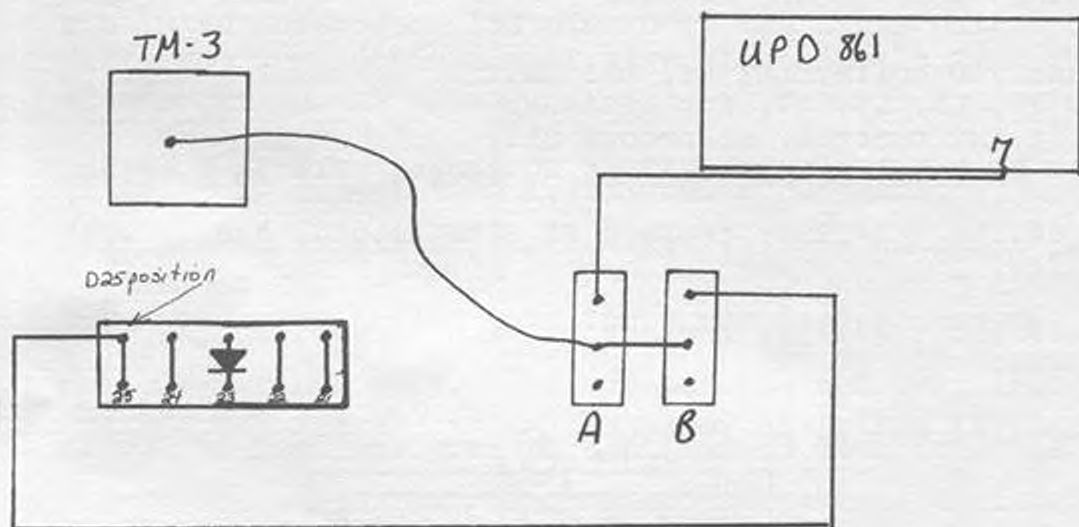

A DOWN; B UP - Regular Channel
A UP; B UP - Up to 27.595
A UP; B DOWN - 26.645 to 26.805
A DOWN; B DOWN - 26.425 to 26.765

SPECIFIC RADIO TUNE-UPS

BOMAN CBR-9950

(Identical to Pioneer GT-1100G)

COBRA 21XLR (Update)

For frequency modification, see President Dwight D - use NB switch. Remove green & blue wires from switch, trace to PC board, remove completely.

Adjust L20, L17 for frequency/power spread.

(See Secret CB, volume 1, page 20, for further information.)

COBRA 66GTL

RX: VR1 - IF gain

VR3 - Squelch range

TX: Peak - L12, L13, L14, L15, L17

VR2 - AMC - D4 defeat

NOTE: Change '90 day wonder' on final.

COLT 800 (Update)

RX: RV1b - Squelch range

RV3 - S meter adjust

TX: Peak - L5, T3, T4, L7, L11, L12

RV2 - AMC (defeat C96)

RV4 - RF meter adjust

NOTE: If you defeat, do not use amplified mike.

SEE: Secret CB, volume 3, pages 4-7 for frequency modification.

(Use Delta Tune switch instead of DPDT switch.)

1. Take all wires off switch.

2. Solder gray & green wires together, sleeve.

3. Blue wire - no connection - sleeve.

Switch wiring - looking from bottom:

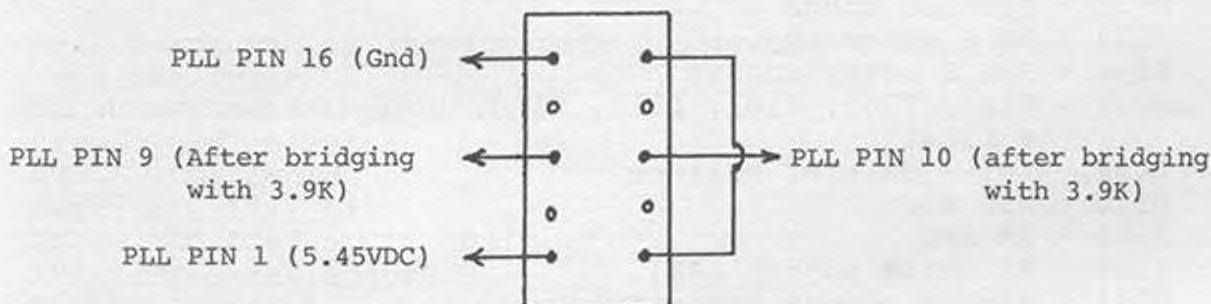

With this configuration the Delta Tune Switch selects frequency mode:

0 = Normal channels

+ = High frequencies

- = Low frequencies

SPECIFIC RADIO TUNE-UPS (Cont'd):

COURIER CLASSIC PLL40 (Update)

Change final to 2SC1306 (get rid of '90 day wonder') on both final and driver - plenty of room to heat sink!

RX: VR1 - AGC
VR2 - S meter adjust
VR4 - Squelch range
VR9 - LO/DX; (LO adjust)
TX: Peak - L901, L903, L906
Leave L907 alone as this is the TVI
VR7 - RF meter adjust
VR6 - AMC (defeat is C508)

For extra frequencies - Pin 3 of PLL to Pin 12 of P11 (Chip ID - M58472P)

CPI CP400

NOTE: Do not adjust L601 & L602!

RX: IF AGC - R306
RF AGC - R292
AM Level - R314
S Meter adjust - R286
TX: Peak - L216, L204, L202, L203
Balance out Ch. 1-40 Power curve: L205, L201
AM Power - R205 (Push it - unit has 40W final!)
RF Level (ALC) - R274
AM Carrier Level - R699
RF Meter adjust - R412
Mic Preamp - R510
(AMC defeat - cut base leg of Q410)

CRAIG L131

RX: R309 - AGC
R307 - RF Gain range
R315 - Squelch range
R229 - AM S meter adjust
R240 - SSB S meter adjust
TX: Peak - T103, T102, T101, L111, L109, L106 (Do not touch C101 & L114)
R414, R401 - Carrier balance
R130 - SSB ALC
R605 - AM AMC
R106 - RF Meter adjust (AM)
R711 - dimmer adjust for display

NOTE: Final is only a 20W unit so don't defeat AMC & ALC!

SPECIFIC RADIO TUNE-UPS (Cont'd):

CRAIG L231 (AM/SSB)

RX: R309 - AGC
R315 - Squelch range
R229 - AM S meter adjust
R240 - SSB S meter adjust
TX: Peak - T103, T102, T101, L111, L109, L106
NOTE: Do not touch (C101A, C101B, L114)
R414, R401 - Carrier balance
R130 - SSB ALC
R605 - AM AMC
R106 - RF meter (AM) adjust
R711 - Dimmer adjust for display

NOTE: This unit has a 20W final so don't defeat AMC & ALC.

DAK MARK II

NOTE: No SAMS available for this radio - use SAMS 190 and refer to ALARON B-4075.

RX: RV101 - Squelch range
RV102 - S meter adjust
TX: Peak: L302, L303, L304, L305, L306, L307, L308, L309 (Do not touch L312 - TVI).
RV219 - Mic gain
RV301 - RF meter adjust

NOTE: If you have trouble getting modulation up, pull C226. SAMS 190 shows C226 as a 33mf diode? (O.E.M. must be broke!) If unit has MPS-u31 final - don't push it!

DELCO 90BFTC1 & 90BCB1 (AM,FM,CB)

RX: RV1 - Squelch range
TX: Peak: T3, L4, L8, L9
RV2 - AMC (defeat, remove RV2)
Unit has a 12W final.

FORMAC 40

(Odd ball company) for service info see: SAMS 166 - refer to Lafayette HB-740.

RX: RV1 - Squelch range
RV3 - S Meter adjust
TX: Peak: L7, L11, L12
RV2 - AMC (defeat is C96)
RV4 - RF meter adjust
Unit has a 12W final.

SPECIFIC RADIO TUNE-UPS (Cont'd):

GE 3-5804F

RX: VR1 - Squelch range
VR2 - S Meter adjust
TX: Peak - L9, L10, L12, L16
VR3 - TX meter adjust
NOTE: NO AMC ADJUST - defeat will overmodulate badly!
1. Pull R83 (10K), put variable 10K in line and adjust.
or: 2. Pull D8, then pull R41, put variable 10K in line and adjust.

GE 3-5805A

RX: VR-2 - S meter light adjust.
VR1 - Squelch range
TX: Peak - L8, L9, L12 (do not exceed 6W, if you cut mod limiter!)
(D13, mod. limiter defeat.)

GE 3-5812A & 3-5811B

RX: RV1 - Squelch range
RV3 - S meter adjust
TX: Peak - L5, T3, T4, L7, L11, L12
RV2 - AMC
RV4 - RF meter adjust
RV501 - AWI (3-5812A)

JC PENNEY 981-8360
(SM5104-PLL)

Change driver to 2SC1306.

RX: RT101 - AM IF gain
RT202 - AM Squelch range
RT201 - AM S meter adjust
RT131 - SSB IF gain
RT251 - AGC (SSB mode adjustment)
RT252 - SSB Squelch range
RT253 - SSB S meter adjust
TX: Peak: T132, T351, T701, T702, T703, T704, L702, L704
RT701 must be fully CW before adjustment!!
RT701 - SSB ALC
RT132 - balanced mod.
RT602 - AM poer
RT002 - RF meter adjust
D405 - AMC defeat

SPECIFIC RADIO TUNE-UPS (Cont'd):

PIONEER GT-1100G(AM-FM-CB)

NOTE: This unit blows drivers! Change final to 2SC1306 and heat-sink Q2 driver.

RX: VR101 - AGC
VR102 - S meter adjust
VR103 - Squelch range
TX: Peak - L10, L7, L6, L4, L3, L1
VR1 - RF meter adjust
VR2 - AMC (Do not defeat!)

NOTE: If you have trouble getting modulation up, tune L6 & L4 for maximum modulation.

PRESIDENT DWIGHT D (858 PLL)

NOTE: Change final to 2SC1306

RX: VR2 - AGC
VR3 - Squelch range
VR1 - S meter adjust
TX: L10 - Keep hands off! TVI
L15, L12 - Adjust for maximum modulation
L11 - NOTE: Some production runs left slug out; put one in and peak out!
L18, L17, L16 - peak out
VR5 - AMC (If you still can't get up, D14 is defeat. Do not remove TR16!)
Change R98 to 1K resistor
VR6 - Modulation meter calibrate
VR4 - RF meter adjust

FREQUENCY MODULATION: Use NB switch - remove green & yellow wires (2) on right side of switch; trace back to PC board and remove. On left side of the switch are 3 wires - remove them and solder all together and sleeve-tie into bundle. Run wires (1 each) from Pins 19 & 21 of PLL to switch. (See Fig. 1)

CH.	FREQ.	CH.	FREQ.
1	27.365	14	27.525
2	27.375	15	27.535
3	27.385	16	27.555
4	27.405	17	27.565
5	27.415	18	27.575
6	27.425	19	27.585
7	27.435	20	27.605
8	27.455	21	27.615
9	27.465	22	27.625
10	27.475	23	27.655
11	27.485	24	27.635
12	27.505	25	27.645
13	27.515	26	27.665

NOTE: May have to adjust L21 & L17 for power/freq. spread.

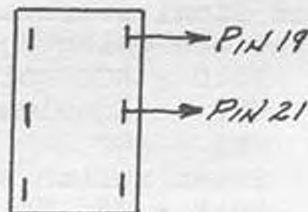

SELECTOR POSITIONS 27-40 normal channels

SPECIFIC RADIO TUNE-UPS (Cont'd):

PRESIDENT AR-44

NOTE: Some units have '90 day wonders' on final and driver - change.

- RX: VR2 - IF gain
VR4 - Squelch range
VR1 - S meter adjust
- TX: Peak - L18, L17, L14, L10
VR3 - RF meter adjust
VR5 - AMC, Defeat C70 (1mf electrolytic)
NOTE: If you defeat, change R76 to 4.3K resistor.

REALISTIC TRC-204 (21-1633) WALKIE-TALKIE

- RX: VR3 - Squelch range
- TX: Switch to high power, peak in this order: T6, T7, L4, L5
Switch to low power - VR4, modulation adjust
Switch to high power - VR5, modulation adjust
AMC Defeat - C52
- You can push this one, as it has a 16W final.

REALISTIC TRC-200 (6 channel WALKIE-TALKIE) 21-184 (Update)

Some units have trouble getting modulation up. (Cut R43, 1K res.)

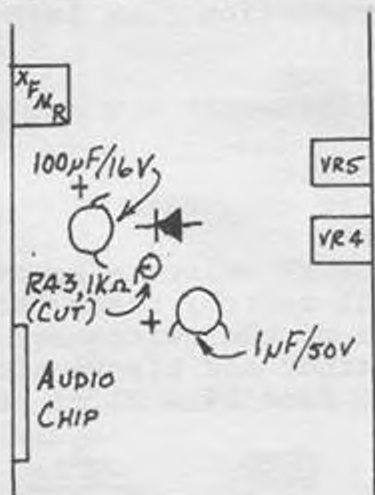

REALISTIC TRC-209 (40 Ch. WALKIE-TALKIE) 21-1660

This unit will do 8W dead key, with NI-CADS!
Check final & driver for '90 day wonders'; some units have them.
If you are going to defeat AMC, change final to 2SC1306.

- RX: VR10 - AGC voltage (adj. for 1.95 - 2.0V at TP1.)
VR2 - Squelch range
VR1 - AGC
- TX: Power Switch to high
Peak - T5, T6, T7, L4, L7, L8
VR9 - TX power adjust
VR6 - RF meter adjust
VR5 - AMC (turn CCW; should be sufficient at 90%; defeat - pull R41.)

SPECIFIC RADIO TUNE-UPS (Cont'd):

REALISTIC TRC-422A (21-1503)

RX: VR1 - AGC

VR2 - Squelch range

VR5 - S meter adjust

TX: Peak - L3, L6, (Do not exceed 5W)

There is no modulation adjust (defeat: cut center leg of Q12)

NOTE: Pull R69 (5.6K), put 10K variable in its place - RF meter adjust.

Change '90 day wonder'on final!

REALISTIC TRC-426 "CB-FONE" 21-1533

RX: IF AGC - VR7

RF AGC - VR1

Squelch range - VR5

RX S Meter - VR3

TX: Max. out - L804, L805, L806, L807, L901, L903

AMC - VR8

TX Power Meter - VR11

AMC Defeat - D507

REALISTIC TRC-448 (21-1561)

SAMS 251 - errors on this unit:

Page 87 - T203 adjust above driver bias, should be marked T205 (left middle of page).

Page 115- SW5, source voltage is 7, not 6.

Change final 2SC2098 to 2SC1307

RX: VR207 - AGC

VR209 - Squelch range

VR206 - S Meter zero

VR205 - S meter adjust

TX: Peak - T201, T202, T203, T204, T205, T206, L207, L208

Carrier Balance - VR3, TC7, T9

VR202 - Final Bias

VR201 - Driver Bias

VR4 - SSB Modulation

VR204 - SSB ALC

VR5 - AM AMC (See Fig. 1, if you can't get up.

VR210 - AM Power

VR203 - RF Meter adjust (adjust in SSB mode!)

VR208 - Modulation indicator (change to red bulb!)

SPECIFIC RADIO TUNE-UPS (Cont'd):

SEARS 934.38062700

RX: RT1 - Mixer gain (cute term! really AGC)
RT2 - S meter adjust
TX: Peak - T11, T12, T13, T14, T15
RT3 - RF meter adjust
Modulation defeat - D7; no AMC adjust. If defeated, change final to 2SC1306.

TEABERRY T CHARLIE (4010)

RX: VR1 - AGC
VR3 - Squelch range
VR4 - S meter adjust
TX: Peak - L901, L903, L905
VR7 - AMC (Defeat C507; see note)
VR5 - RF meter adjust
NOTE: If defeat AMC, change final to 2SC1306 and heat sink the driver - even if you don't change it.

TEABERRY STALKER VIII

RX: VR3 - Squelch range
VR4 - S meter adjust
TX: Peak - L10, L11, L15
VR5 - RF meter adjust
AMC Defeat - C-49, electrolytic capacitor.

TEABERRY STALKER IX

NOTE: See Vol. 4, pp. 7,8 of Secret CB for frequency & slide mod.
RX: VR2 - Squelch range
VR1 - S meter adjust
TX: Peak - (In this order) L, 26, L27, L28, set VR7 to minimum
Peak - in USB L29, L36
VR8 - Driver bias
VR9 - Final bias
VR5 - Carrier bias
VR7 - ALC
VR6 - AM Power
VR10 - TX Meter adjust
CAUTION: Unit only has 20W final!

TENNA 10902

RX: R94 - Squelch range
R28 - S meter adjust
TX: Peak - T11, T12, T13, T14, T15, T16, L4
R71 - AMC
R90 - RF meter adjust
R132 - SWR meter calibrate

UNCONVERTABLE AT THIS TIME

MAKE	CHIP	AMC	TUNE-UP
<u>Cobra</u>			
19GTL	TC9109P	VR6	L11,L12,L15
21GTL	TC9106P	VR5	L14,L10
25GTL	TC9106P	VR5,	VR5,L14,L10
<u>Craig</u>			
L103	TC9109P	TR17	L12,L13,L16
<u>President</u>			
AR7	TC9106P	TR17	L12,L16
AR14	TC9109P	TR8	L11,L12,L15
AR44	TC9106P	VR5	L14,L10

These chips are manufactured by TOSHIBA. I am currently trying to obtain data sheets on these from Japan. If anything develops we will let you know about it in Volume 11! Meanwhile, has anybody had any breakthroughs? Send all material to:

Selman Enterprises
P.O. Box 8189
Corpus Christi, TX 78412
Att. Vic

MODULATION ADJUSTMENTS FOR NEW RADIOS

Realistic TRC 425 -

Clip D508. If distorted, add another diode in series with D508 and resolder. This will give more modulation because of less feedback.

Realistic TRC 422A -

Clip R88, for maximum modulation. Zapper 9000 would go in place of C45 for more frequencies.

Realistic TRC 441 -

Clip D109, for maximum modulation. Zapper 9000 would go in place of C152 for more frequencies. VCO adjust is at T111. For LOW and HI channels, replace D118 with a Super Clarifier diode. Peak out T114, L107, L104.

Realistic TRC 456 -

Use the channel modification for the UPD 861, Vol. 7 page 24. For modulation, adjust VR8, or remove Q505.

Midland 100M -

Use a Zapper 9000, for extra channels. For maximum modulation, remove Q202. Peak L301, L302, L303, L304, L305 and L306.
RV201 is for AMC.
RV202 is for the Power Meter.
RV101 is for the SQ. range.
RV103 is for the Signal Meter.

LINEAR SUGGESTIONS

1. If your linear will not key in, listen closely to see if you hear the TX/RX relay click. If not, the problem is usually the key-up transistor. Most units use a 2N2222A. Cost ± \$1.00.
2. If you linear runs too hot, check output transformer for number of turns. If it has 3 or 4 turns, add one more turn, using TEFLON wire only! The output transformer is the larger of the two.
3. If you have high SWR's on output, change the capacitor on the output transformer to a variable capacitor and tune to antenna or change from a 750pf to a 250pf dipped mica.
4. High SWR's from radio to linear on input can be helped by changing the capacitor on the input transformer to a variable capacitor of same range or change to 250pf mica.
5. If your unit sounds good on SSB, but bad on AM, you can build a high-medium-low switch as previously described elsewhere in this volume. By using the low position you will get excellent forward drive with modulation.

If you drive the amp with 5 watts and get 100 watts output, you have no leeway for AM modulation. At 3 watts you get about 80 watts, which will drive upward with modulation. Using the low position on a 100 watt linear, you will get about 20 watt dead carrier with 60 watts p-e-p and 100% modulation, with no modulation distortion.
6. Make sure your antenna is rated for the high output power of your amplifier. An improper antenna, or one not properly adjusted, can cause excessive heat and probable transistor destruction.
7. The average amp. is designed to operate with an XMTR maximum output power of 4.25 watts AM, 12 watts PeP. SSB. Amps with higher input power levels will be noted on the rear of the chassis.
8. Be sure you install your amplifier in a location where the heatsinks will be exposed to air circulation.
9. The hot lead of the amp. must be connected directly to the battery, with heavy gage wire of 6-10 awg, depending on current demand of amp and length of run. Ground Black lead to chassis. Neg. ground system only.

LINEAR SUGGESTIONS (CONT)

10. Key up XMTR and linear, and release. If XCVR does not return to RX mode (hangs up), this is an indication that the length of coax between the amp and radio (or antenna), may not be optimum. Increase the coax length by three feet.
11. Check SWR. It should be less than 2, with amp. on. If you cannot tune it below 2, suspect installation-such as Amp. grounding, bad antenna, XCVR grounding, or coax length.

90% of all problems encountered with a linear can be traced to inadequate installations- often antenna or wiring.

4 POSITION SWITCH FOR LINEARS

HI-MH-MD-LO

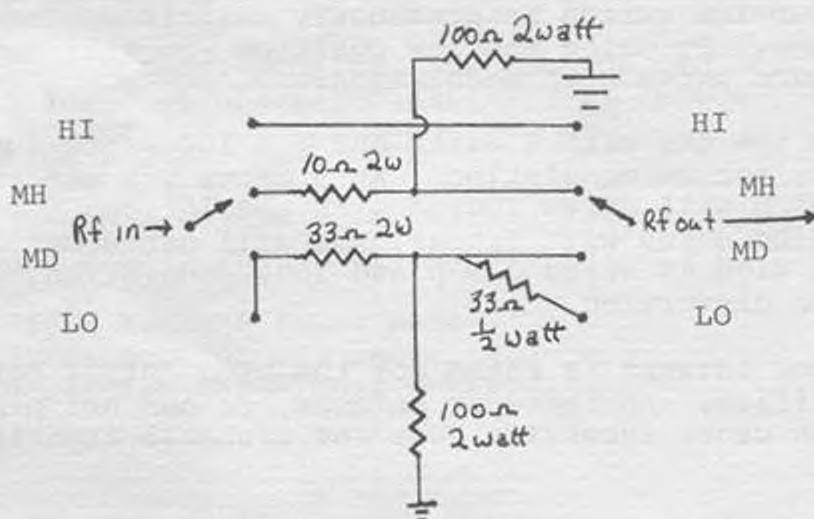

PARTS LIST

- | | |
|---|---------------------------------|
| 1 | 2 pole 4 position rotary switch |
| 1 | 10 ohm 2 watt carbon resistor |
| 1 | 33 ohm 2 watt carbon resistor |
| 1 | 33 ohm 1/2 watt carbon resistor |
| 2 | 100 ohm 2 watt resistor |

ZAPPER INSTALLATION HINTS

Sometimes a seemingly simple conversion, such as installing a Zapper 9000 kit turns out to be a 'tough dog'. Let me share a little bit of wisdom gained from experience on the bench. The radio in question is a Midland 77-101C. Could't get HI or LOW channels by inserting the Zapper leads in place of C205 as directions state. Here's what I did. I lifted the end of C205 connecting to join pin 13 of the PLL. Inserting it here gave NORMAL channels and HI channels but the LO channels were unstable. Adjusting VCO didn't help stability (frequencies were there but not stable). Disconnection of the shield solved the stability problem. However, then we would lose NORMAL channels. So we added another SPDT switch as shown:

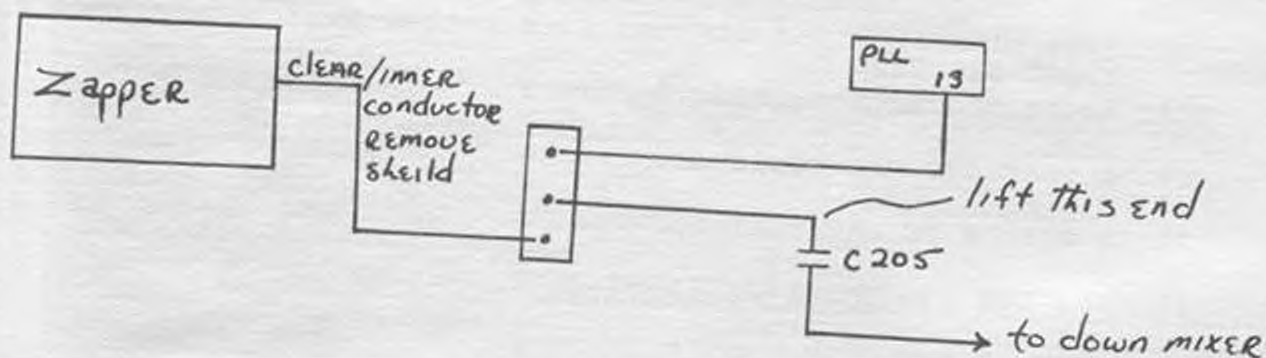

To get full coverage from 26.515 to 27.855 I replaced D201 Varactor with a Super Clarifier Diode (order our item #28), and adjusted L203.

To check out the Zapper, use frequency counter. Connect input to the center wire and ground to the BLACK wire. You should read 15.810, 14.910, or 14.905 depending on which model you buy.

"OOPS, WE GOOFED"

Volume 3 page 33:

PLL CHANNELIZER PARTS LIST & EXPANDED DIAGRAM

Parts List

- 1) G.C. Electronics 3 station push button switch (interlock type) #35-922
- 1) Radio Shack chassis #270-251
- 1) 1 watt 470 ohm resistor
- 1) ¼ watt 4.7K ohm resistor
- 1) Red LED (jumbo, 1³/₄ size)
- 1) Green LED " "
- 1) Yellow LED " "

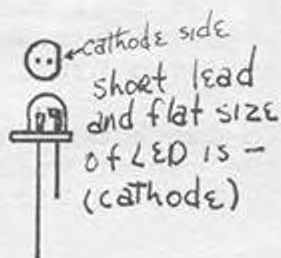
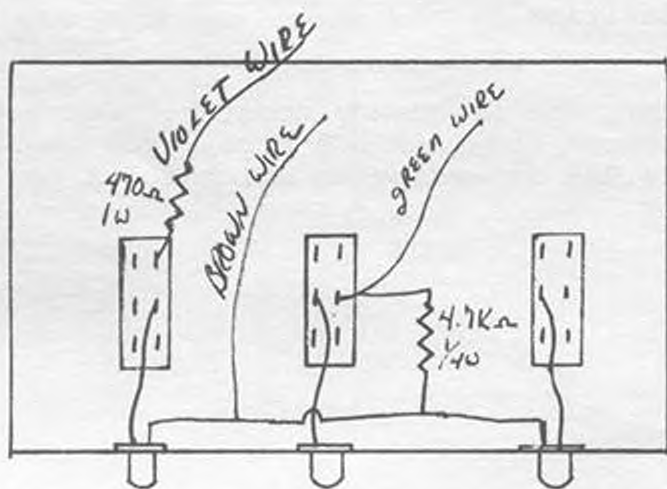

"OOPS, WE GOOFED"

Volume 5 page 24:

Step 2- Do Not cut R148

Step 3- VR11 will be disabled if you do step 4.

Step 4- To open AM modulation with out disabling the SSB ALC, cut D54, instead of TR24.

Volume 5 page 28:

Step 1 (last sentence) Change D309 to read D304, and D310 to read D306.

Volume 5 page 48:

M.A.R.S. is no longer available.

Volume 8 page 16:

1. Do not remove R174.

Skip Step 3.

2. To wideband, remove C207. Change R206 to a 47K ohm resistor. For more VCO range, make a cut on pin 6 trace of IC2 VCO and install a Super Clarifer Diode across the cut with the cathode towards Pin 6.

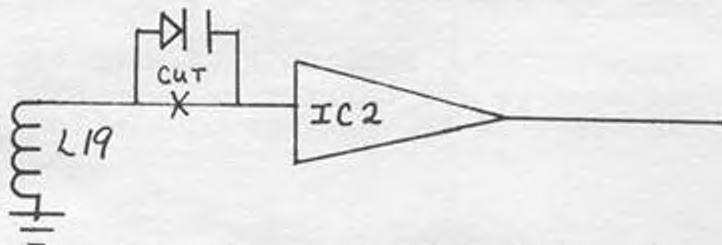

There is still some confusion concerning page 17 in Volume 8, and page 29 of Volume 9, concerning the Xtals. It was unfortunately omitted in Volume 8, that you must use an oscillator circuit in which the Xtals can oscillate and therefore feed that frequency into the location of the removed capacitor. In Volume 9, the schematic shown is NOT the oscillator circuit. The circuit outlined is simply for electronically switching

"OOPS, WE GOOFED"

different crystals in and out of circuit, which is especially useful in Browning Mark conversions. It is unfortunate that the two items didn't get separated because they are two different subjects.

In Volume 10, the prevalent attitude is that of re-establishing the idea of "get it right the first time". We thank all of our readers who have borne with us, and used their "nickel" to call us and obtain correct information.

Volume 8 page 16:

148GTL UPDATE

1. Unsolder the ORANGE wire on the clarifier and run a new wire from the clarifier to pin 1, of IC4.
2. Remove R175 and install a jumper wire in place of it.
3. Clip R44.
4. Clip D52.
5. For more slide, replace D35 with a Super Clarifier Diode.

L59, USB; L23, AM; L22, LSB.

Widebanding-

Remove C207. Replace R206 with 47K ohm. Readjust VR4 if necessary, for carrier null on SSB.
Remove TR24 for maximum modulation. VR10 is AM carrier pow.

"OOPS, WE GOOFED"

Volume 9 page 9:

UNIDEN 858 PLL UPDATE (cont'd)

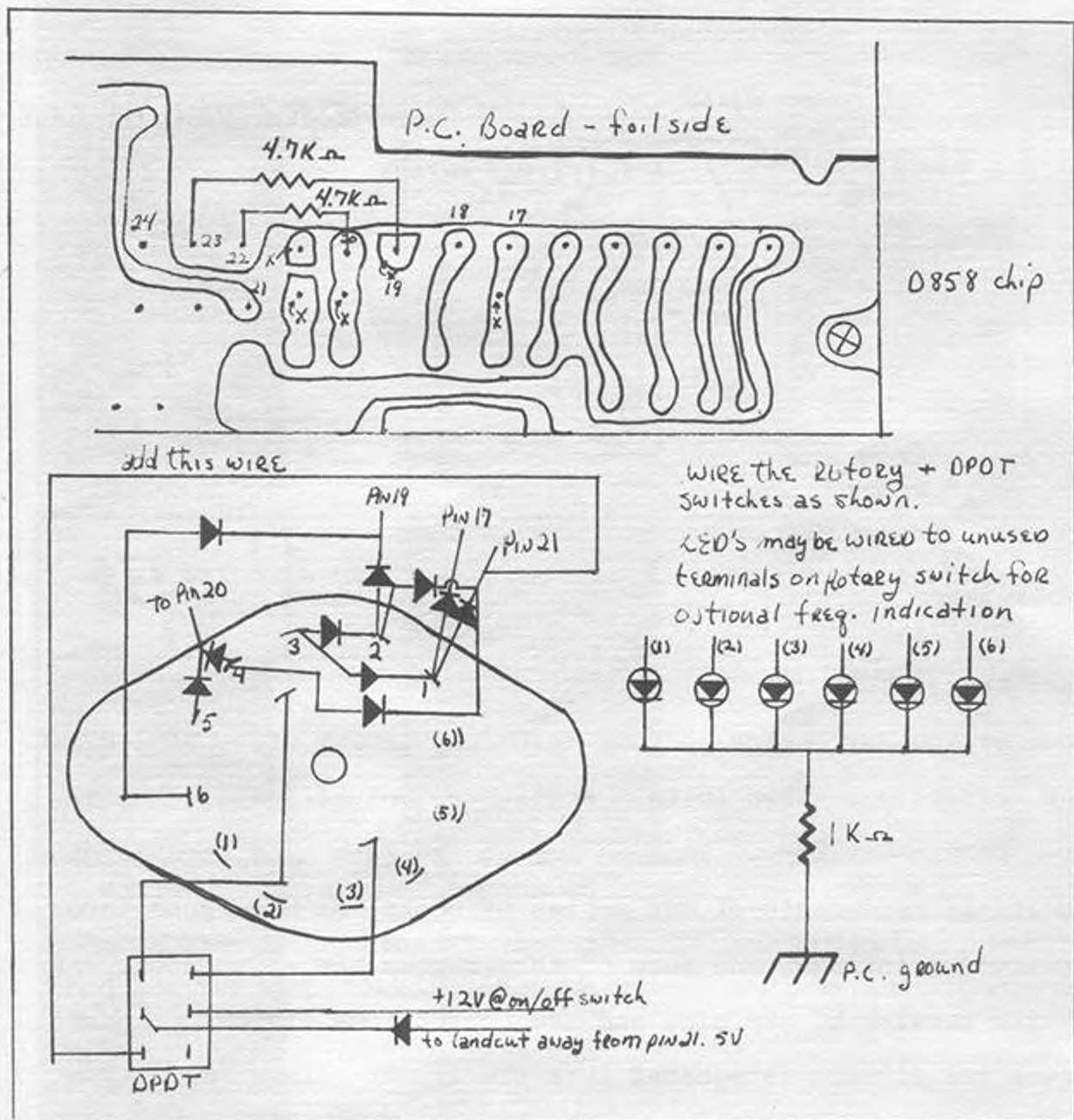

"OOPS, WE GOOFED

Volume 9 page 51:

HINTS & KINKS

Switchable Modulation Increase

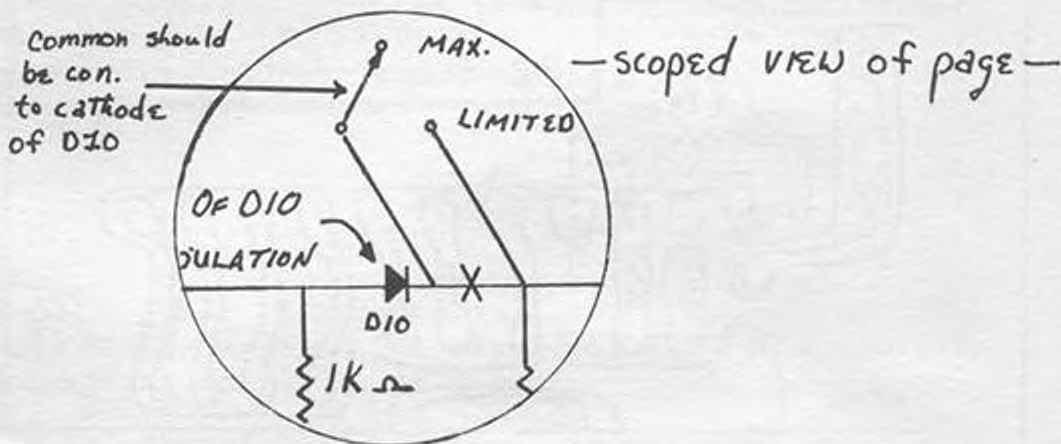

Dear Readers:

Some of you may notice in your issues of SECRET CB, that some of the corrections shown in this section of Volume 10, are not in your particular copy. This is due to the fact that because of increased readership of our series of books, we have gone into multiple printings, and some of the volumes are an updated, corrected version of the old, and the corrections listed on these pages are already integrated into the latest printings.

SEE YOUR LOCAL CB DEALER OR ORDER DIRECT

SECRET CB ORDER FORM



Volume I



Volume II



Volume III



Volume IV



Volume V



Volume VI



Volume VII



Volume VIII



Volume IX



Volume X

SELMAN ENTERPRISES, INC.
P. O. Box 8189
Corpus Christi, Texas 78412
Phone 512 992-1303

- | | |
|--|--|
| <input type="checkbox"/> \$15.95 Vol. I | <input type="checkbox"/> \$15.95 Vol. VI |
| <input type="checkbox"/> \$15.95 Vol. II | <input type="checkbox"/> \$15.95 Vol. VII |
| <input type="checkbox"/> \$15.95 Vol. III | <input type="checkbox"/> \$15.95 Vol. VIII |
| <input type="checkbox"/> \$15.95 Vol. IV | <input type="checkbox"/> \$15.95 Vol. IX |
| <input type="checkbox"/> \$15.95 Vol. V | <input type="checkbox"/> \$15.95 Vol. X |
| <input type="checkbox"/> \$19.95 Secrets of Satellite TV | |

SHIP TO:

Name _____

Address _____

City _____ State _____ Zip _____

Ship Via: UPS First Class Parcel post Other _____

Send Check, M.O. or C.O.D. only. Add \$1.00 per book for shipping. Visa, Master Charge accepted. Add 3% for handling.

IT FINALLY HAPPENED...

CB PARABOLIC TYPE ANTENNA!

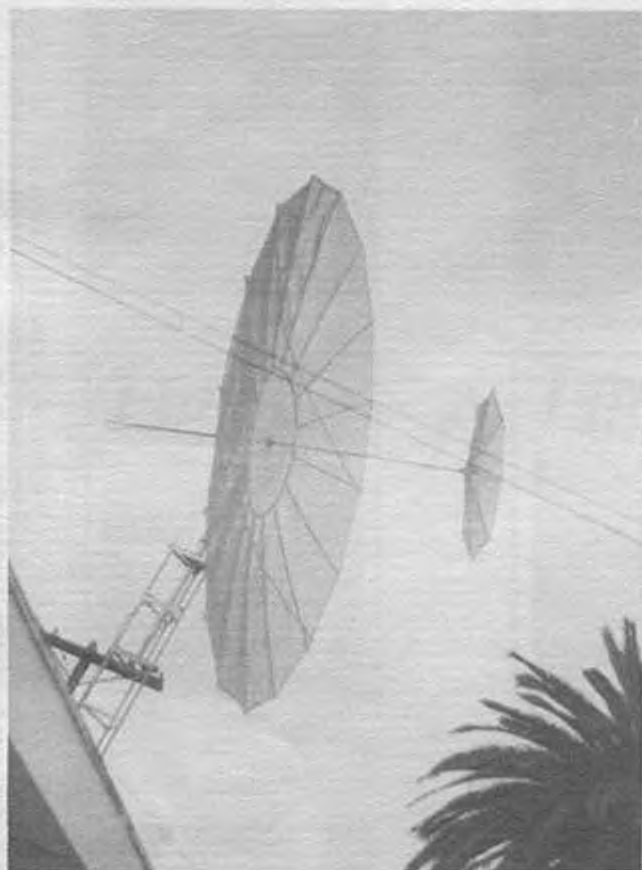

- * Model design, "Elephantears"
- * Receives and Transmits
- * Circular Polarity
- * Vertical and Horizontal
- * 14 ft. Diameter
- * "Elephantears I, 75Lbs.
- * "Elephantears II, 85Lbs.
- * Power Rating- 25KW P.E.P.
- * Bandwidth 26MC-28MC
- * Price- approximately \$995.00

Many thanks to Dave Chavez for contributing his time and pictures.

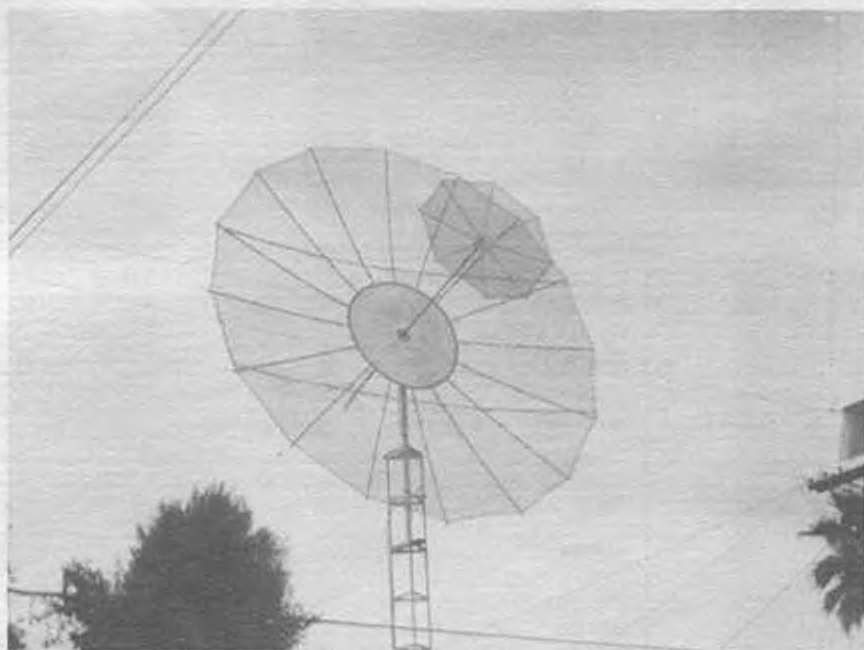

CALL 512/992-1303

Don't Forget To Ask For Our Catalog.

New Book Release

LEO'S C.B. SHOP
RT. 2, BOX 158-B
JASONVILLE, IN 47438
PH. 812-665-3837

**ORDER FROM YOUR
DISTRIBUTOR NOW!**



**Sell Satellite TV
For An Interesting Way
To Earn Additional Money**

**SELMAN ENTERPRISES, INC.
P. O. Box 8189
Corpus Christi, Texas 78412**

SECRET
SECRET

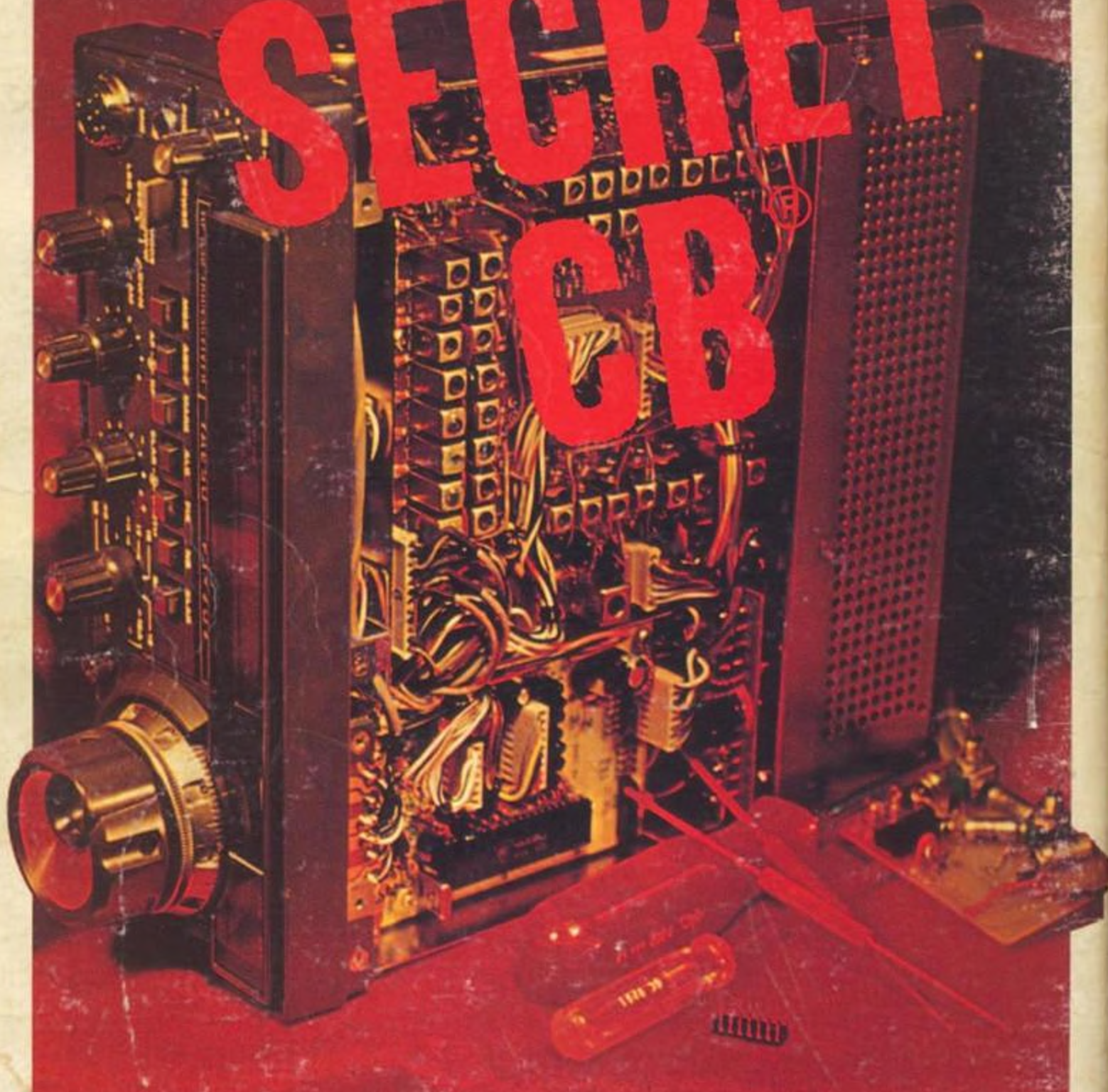

LET'S C.B. SHOP
RT. 2, BOX 158-B
JASONVILLE, IN 47533
PH. 312-665-1857